

**Maneuver Center of Excellence (MCoE) Libraries
HQ Donovan Research Library
Armor Research Library
Fort Benning, Georgia**

Report date: 9 July-31 October 1950

Title: United States Army HQ 2nd Infantry Division War Diary from 9 July-31 August 1950 and from 1 September-31 October 1950

Abstract: U.S. Army HQ 2nd Infantry Division War Diary to include staff section report from 9 July- 31 August assigned to 8th United States Army, Far East Command; and staff section report from 1 September-31 October 1950

Number of pages: 739

Notes: From the MCoE HQ Donovan Research Library, Fort Benning, GA.
Microfilm collection #: DS 17 Item no. 17

Classification: Unclassified; Approved for public release

SCREENED By OCAFF
Date SEP 5 1951

302
Master

*Screened
car*

SECRET
DEPARTMENT OF THE ARMY
THE ADJUTANT GENERAL'S OFFICE
WASHINGTON



War Diary with Staff Secs - 2d Inf Div

OPERATIONS BRANCH A.G.O.

CLASSIFIED RECORDS

AGO MICROFILM
ITEM NO: 17

9 Jul-Aug 1950

SECRET

SECRET

WAR DIARY



u
o
p

HEADQUARTERS

2^d INFANTRY DIVISION

9 JULY 50 - 31 AUGUST 50

COPY No 1

SECRET

Master

WAR DIARY

HEADQUARTERS
Second Infantry Division
APO 248, c/o Postmaster
San Francisco, California

From: 8 July 1950 Through: 31 August 1950

Assigned To: 8th United States Army,
Far East Command,
APO 30, US Army.

CONTENTS

1. Classified Announcement
2. Distribution
3. List of Inclosures (Supporting Documents)
4. War Diary - Record of Daily Entries
5. Staff Section Reports
6. Volume 1 Narrative Summary

ATTENTION

The material contained in this War Diary is classified SECRET in accordance with the provisions of AR 380-5 and Par 8, SR 345-105-1, 3 Feb 1949.

The following is quoted for the information and guidance of all concerned:

DISSEMINATION OF CLASSIFIED MATTER. No person is entitled solely by virtue of his grade or position to knowledge or possession of classified matter. Such matter is entrusted only to those individuals whose official duties require such knowledge or possession. (Par 11, AR 380-5)

DISTRIBUTION

Total Number of Copies Prepared:

War Diary - 7 Copies

Supporting Documents - 1 set with the following exceptions: G-2 (Miryang Journal, Gen O File, Staff Conf File which have been prepared and are being transmitted in duplicate.

Copies 1-6 with supporting documents as indicated forwarded to the Commanding General, Eighth United States Army, Far East Command, for ultimate distribution as follows:

- (1) Four copies, including copy No. 1, with supporting documents, to the Department of The Army.
- (2) One copy to Commander in Chief Far East Command.
- (3) One copy, with duplicate copies of supporting documents indicated above to Commanding General, Eighth United States Army, Far East Command.

NOTE: Copy 7 to be retained in files of Headquarters Second Infantry Division.

LIST OF INCLOSURES

Staff Section Reports Headquarters 2d Infantry Division:

G-1
G-2
G-3 (See note reference G-3)
~~G-3~~
Chemical
Engineer
Ordnance
Quartermaster
Signal
Surgeon
Transportation
AG
IG
Public Information
Finance
Provost Marshal
Special Service
Staff Judge Advocate

Staff Conference File

General Order File

Classified Movement File

Classified Personnel File

Classified Supply and Equipment File

Classified Training File

Classified Miscellaneous File

G-2 Miryang Journal Entries 1-392

G-2 Journal Entries 1-502

G-2 Miryang Journal File (J1-J120; J121-J250; J251-J392)

G-2 Journal File (J1-J190; J191-J273; J274-J353; J354-J442;
J443-J515; J516-J583)

SECRET

HEADQUARTERS SECOND INFANTRY DIVISION
WAR DIARY

082142 July 50 - 092400 July 50

Entry No	Time of Action	Authority	Action	Ref
1.	082142	TWX, CG	Per instructions Colonel Lipscomb G-3 the Commanding General of the 2d Infantry Division was informed that the Department of the Army would announce in Washington at 1000 hours 9 July 1950 for release to the press: "The 2d Inf Div has been alerted for movement in the near future to the Far East Command. Authorization granted for simultaneous release by CG 2d Infantry Division."	Classified Movement File 2d Inf Div Entry #5
2.	0047	TWX WAR 85514	Criteria established for organization and shipment of 2d Infantry Division: <ol style="list-style-type: none">2d Inf Div, 56 Amph Tk Trac Bn, and 50 Engr Port Constr Co will be shipped at full T/O & E strength and equipment through Seattle POE on PCS to FECOM. Units assigned FECOM effective upon arrival. Directions being issued reorganizing units immediately to full T/O & E.2d Engr Spec Brig will be shipped as currently organized and equipped through Seattle POE on PCS to FECOM unit assigned FECOM effective upon arrival.Officers and enlisted personnel now assigned units will meet criteria established SR 600-175-1 except personnel may be shipped who served less than one year in ZI since last overseas tour. Officers with 6 months or more remaining to serve in present category upon arrival POE and enlisted personnel with six months or more service remaining upon arrival POE are eligible for shipment with unit. Compassionate cases resolve by CG 6th Army. Commanders of units will be governed by the provisions of paragraph 51-56 of SR 55-720-1 in preparation of personnel for movement overseas. <p>Authority to restrict leaves including cancellation of leaves already granted in accordance military necessity.</p> <p>Direct communication authorized with commands to effect cancellation of delay enroute for personnel assigned 2d Inf Div and specify date of reporting. Enlisted and officers school being directed to return all personnel units 2d Inf Div in sufficient time arrive their units: by 21</p>	Classified Personnel File 2d Inf Div Entry #1

SECRET

SECRET

HEADQUARTERS SECOND INFANTRY DIVISION
WAR DIARY

082142 July 50 - 092400 July 50 Continued

Entry No	Time of Action	Authority	Action	Ref
----------	----------------	-----------	--------	-----

Entry 2 continued:

July 1950.

Approximately 5,000 personnel being ordered from Zone of Interior units to report not later than 31 July 1950. Additional shortages will be filled by personnel available 6th Army to extent practicable. DA will be informed EPD of officers and enlisted personnel shortage of units on departure.

Officers under orders to CGSS, AFSC, AWC, Industrial College, National War College, Civilian School, and field grade officers under orders Advance Branch School will not be shipped with unit.

Levies placed on units cancelled.

- SR 55-720-1 dtd 7 Nov 49 and WD Pamphlet 29-11, 2 Mar 47 apply. Units will move in category one as set forth in paragraph 10-cited SR except general purpose vehicles will accompany units. Further instruction reference requisitioning company and shipment numbers follow. Priority for shipment: 2d Div, 2 ESB, 56 Amph Tk Trac Bn and 50 Engr Pont Constr Co. Target date for 1st elements to commence loading 25 July 1950.
- Direct communication authorized above addressees in connection with these movements.

Release of information to press will be made only by Chief of Information Department of the Army.

- Additional instructions not covered above ref URMMSG cited and will be issued by separate communications."

3.

0601

MSG CG 6th
Army to CG
Fort Worden
AMAGP-07166

"Ref WAR 85295. Submit by 130800 July rqn as of 101800 July to bring units as listed ref WAR msg to curr auth str. EM sch disch prior 1 Feb 51 and Off whose cat expire prior to 1 Feb 51 will not be included in compiling reqn. Use DA Form 477 or substitute for submitting regn."

Classified
Personnel
File 2d Inf
Div Entry #

3A

SECRET

SECRET

HEADQUARTERS SECOND INFANTRY DIVISION
WAR DIARY

082142 July 50 - 092400 July 50 Continued.

Entry No	Time of Action	Authority	Action	Ref
4.	1415	Transcript Telecon Gen Keiser Gen Davidson	<p>a. Answers to availability of shipping from General Jacobs will not be forth coming for at least 24 hours.</p> <p>b. 5,000 replacements to be siphoned into 2d Div - clarification requested.</p> <p>c. All loading plans based on combat loading. Clearance requested from Gen Davidson.</p> <p>d. CG 2d Div in the interest of unit efficiency, morale and best interests of country requested retention of key commanders such as Colonel Messinger and Colonel Peplow despite present intention of assigning them to War Colleges. Gen Davidson remarked that efforts for clarification of this problem would be promulgated.</p> <p>e. Gen Davidson requested information as to whether it would be possible to "beat" existing target dates and what units would or could leave earlier. This information to be transmitted to WDC by the 10th.</p>	Classified Misc File 2d Inf Div Entry # 1
5.	1848	Msg CG 6th Army to CG 2d Div ALAGP2- 07167	"Desire immediate report be made to TAG attn AGPA-OS with info copy this Hq by name, rank, and branch all off of Second Inf Div who have PCS orders rel them fr Second Inf Div with EDCM of 15 July or later. Further indicate which of these have already departed Fort Lewis.	Classified Personnel File 2d Div Entry # 3
6.	2250	Synopsis of Telecon	<p>The following synopsis was prepared of a telephone conversation between Brig Gen Gar Davidson, C/S of Sixth Army and Major General L. B. Keiser, CG of 2d Inf Div:</p> <p>Gen Davidson asked about information getting to ESB (Col Twitty) and Gen Keiser stated it was being forwarded as received.</p> <p>Gen Davidson discussed unit loading and Gen Keiser again emphasized that the phrase "prepared for action" meant nothing but "<u>combat loading</u>".</p> <p>At this time Gen Davidson indicated that General Mac Arthur was the force demanding the 2d Div ship out at the earliest. Gen Keiser informed Gen Davidson that General Mac Arthur's queries as to when the 2d Division could get over there were dependent upon shipping availability and that this information could not be obtained from General Jacobs, that the DA was the source of this information.</p>	

SECRET

SECRET

HEADQUARTERS SECOND INFANTRY DIVISION
WAR DIARY

082142 July 50 - 092400 July 50 Continued

Entry No	Time of Action	Authority	Action	Ref
-------------	-------------------	-----------	--------	-----

Entry 6 Continued:

General Davidson then replied that he would relay FECOM's requests direct to the DA and send info copies to the 2d Div.

It was then indicated by Gen Keiser that the Tank Bn and other Divisional special troop detachments would follow the RCT's in the schedule furnished Gen Davidson and further reminded him again that shipment of tanks required special type shipping.

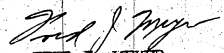
FRED J. MEYER,
Captain, Infantry,
Division Historian.

SECRET

SECRET
HEADQUARTERS SECOND INFANTRY DIVISION
WAR DIARY

100001 July 50 - 102400 July 50

Entry No	Time of Action	Authority	Action	Ref
1.	0242	WAR 85361	In a communication addressed to the CG 6th Army PSF, Calif and information of the CO, Ft Lewis, Wash it was indicated to facilitate routing of requisitions representatives of CHORD, CHENGERS, CHSIGO, QMG, and SG would report at earliest possible date to Fort Lewis to render technical assistance. It was further indicated that the 2d Div would be required to move with M4A3 tanks on hand and shortages would have to be filled from M26 Tanks on hand, M26 Tanks at Yakima, and M4A3 Tanks in Ord Depot Stocks in this order. Units are to move with all 2.36 inch rocket launchers and a duplicate quantity of 3.5 inch rocket launchers. Ammunition for 3.5" rocket launchers being shipped direct to FECOM. 57mm, 75mm rifles and sniper scopes not available at this time.	Classified Movement File 2d Inf Div Entry #6
2.	0452	TWX CG 2d Div to CG 6th Army AMBCS 7-159	RE TELECON GEN DAVIDSON No definite information on shipping. 25 July earliest target date for first elements to commence loading. Priority 9-23-38 RGT's. Estimated three days to load 1 RGT provided adequate shipping, berthing, dock facilities, and Port personnel are available for simultaneous loading.	Classified Movement File 2d Inf Div Entry #7
3.	0624	Msg fr CG 6th Army to TAG WDC ATTN ACoFS G-3	"Attn Brig Gen D. A. Ogden. Ref telephone conversation between Gen Ogden and Gen Davidson. Based on information available to present movement estimate target date 25 July indicated in your WAR 85314 earliest first elements Second Division can commence loading. Priority 9-23-38 RGT. Estimate 3 days to load 1 RGT provided adequate shipping, berthing, dock facilities and Port Personnel are available for simultaneous loading. Attention invited CX 57546 CINCPAC Tokyo to CG 6th Army info DA. Desired info not available SEPE request you make reply and inform this Hq and Second Division. Division planning proceeding on basis of combat repeat combat loading instead of convoy loading. Div Commander and this Hq consider this type loading imperative. REURWAR 88814 all PCS orders must be cancelled or combat effectiveness of Div will be reduced to an unacceptable degree. High percentage key field officers under orders to schools must be retained.	Classified Personnel File 2d Inf Div Entry #1A
4.	0850	Tel Trans Gen Jacobs Gen Keiser	Gen Jacobs called reference shipping facilities for orgn moving to Alaska. Gen Keiser queried on status of 2d Div movement and transport facilities again reiterating need for sufficient transport to combat load by units.	Classified Misc File 2d Inf Div Entry # 2

SECRET

SECRET

HEADQUARTERS SECOND INFANTRY DIVISION
WAR DIARY

100001 July 50 - 102400 July 50 Continued:

Entry No	Time of Action	Authority	Action	Ref
5.	1230	Transcript Telecon Gen Davidson Gen Keiser	<p>a. Department of Army target date set for shipping: One (1) 17th, one (1) 18th, one (1) 19th, one 23rd, one (1) 26th, two (2) 27th, all ships to be V type. No standard capacity. Dependent on modification. Estimate adequate space for one (1) BCT.</p> <p>b. Per request of General Keiser clarification of troop levies on units based at Fort Lewis obtained. 2d Infantry Division authorized to make limited levy on 4th RCT.</p> <p>c. Possibility of shipping units without full equipment and troop complement considered. Balances to be shipped and joined at destination.</p> <p>d. Brigadier General Joseph Sladen Bradley named as Assistant Division Commander to depart from Fort Benning by air on 15 July to join organization. Colonel Tully considered for post of Deputy Division Commander however General Bradley had already been named. Colonel Tully to accompany Division as Chief of Staff.</p> <p>e. Reference previous request of General Keiser in conversation with General Davidson on 9 July assurance given that all PCS Orders after 15 July would be cancelled, this to include everyone regardless of assignment to Industrial or War Colleges.</p> <p>f. General Keiser requested clarification of status of reserve officers with 91st Division and other infantry units desiring to volunteer for active duty. Would or could orders be issued for their recall to insure preservation of civilian job status.</p>	Classified Misc File 2d Inf Div Entry #3
6.	1315	Transcript Telecon Gen Keiser Gen Jacobs	<p>MSTS called General Jacobs indicating preparation of list of ships capable of transporting 25,000 personnel, by 11th more adequate information should be available. General Jacobs requested representative from G-3 be supplied. Representatives of G-3 and G-4 to report to Fort Lawton 11th for coordinating movement plans. General Jacobs received information on tentative shipping dates paralleling those previously received on 9 July by General Keiser from General Davidson. However ships to be made available to include troop transports as well as V ships. General Keiser's desire to <u>combat load</u> concurred in.</p>	Classified Misc File 2d Inf Div Entry #4

SECRET

SECRET
 HEADQUARTERS SECOND INFANTRY DIVISION
 WAR DIARY

100001 July 50 - 102400 July 50 Continued:

Entry No	Time of Action	Authority	Action	Ref
----------	----------------	-----------	--------	-----

Entry 6 Continued:

Ships will be loaded to facilitate unloading without regard to space utilization. Determination on port of shipment must be clarified. Transportation for 2d Division liaison group to be supplied by General Jacobs. Probability of obtaining LSD's or LST's for transport of organic type tank companies considered.

7. 1400
 Transcript
 Telecon
 Gen Jacobs
 Gen Keiser

Tentative departure date and ships to be allocated to the 2d Infantry Division movement:

<u>Departure Date</u>	<u>Vessel</u>	<u>Departure Date</u>	<u>Vessel</u>
18 July	Mann P-2	31 July	Gen Breckenridge P-2
3 Aug	Pvt Martinez VC-2	5 Aug	Gen Sturgis
7 Aug	Gen Stewart	3 Aug	Gen Collins
6 Aug	Gen Greeley	16 Aug	Gen Bellieu
16 Aug	Gen Randall	9 Aug	Pres Jackson
15 Aug	Pres Thomas Jefferson		

Classified
 Misc File
 2d Inf Div
 Entry #5

Ship capacities still being worked on. Dates given are ETS efforts being made to obtain ETA. General Jacobs to contact General Davidson reference information previously given to General Keiser on 9 July reference proposed shipping dates. Seems to be duplication of dates and confusion as to exact type of ship. Further action to be initiated to determine status of LSD's for movement of 1 tank battalion, 3 companies (1 per regt) plus one armored reconnaissance company.

8. 1640
 Transcript
 Telecon
 Gen Jacobs

General Gar Davidson contacted General Jacobs reference seven (7) V ships previously discussed and it appears that information is sketchy and it is not known for certain whether these ships are consigned to the 2d Division. However contact with a "Beston" in Washington indicates the possibility that these ships were intended for tank and heavy equipment transport. General Jacobs TMQ, Major Turnbull has been in Washington for past two days obtaining information governing transport for movement; expected to return by 11th, in transit at present by air. MSTS does not have any definite information concerning seven (7) ships they will continue search. Captain Eaton MSTS Deputy at Seattle POE will continue efforts to find out. He was unable to do so today as office which could supply information closed at 1630 hours. Information indicates one (1) additional ship the General Brewster has been

Classified
 Misc File
 2d Inf Div
 Entry #7

SECRET

SECRET

HEADQUARTERS SECOND INFANTRY DIVISION
WAR DIARY

100001 July 50 - 102400 July 50 Continued:

Entry No	Time of Action	Authority	Action	Ref
Entry 8 Continued:				
added with a sailing date of 24 July. When the liaison group from the 2d Division reports to Seattle POE on 11th it is desired that they have information on personnel strengths so that planning can commence. DA is sending teletype in morning directing unit loading. Unit loading in this respect enabling selective organization of CT's without disruption of shipping schedules. This requires knowledge on equipment disposition. If seven (?) V's belong to 2d Division they should be loaded accordingly. (Liaison group set up and scheduled to report to SPOE.)				
9.	1730	MSG CG 6th Army to TAG DA AMAG-2 07180	"Ref msg AMBAG-OBOE 7-160 from CG 2d Infantry Division Fort Lewis Wash to TAG for AGPA-OS dtd 10 Jul 50 listing names of 83 off and WO presently asgd 2nd Inf Div under PCS orders rel them from 2d Inf Div. Rqst immediate revocation PCS orders Off and Warrant Off pers listed above cited msg in order pers to accompany unit. Further rqst immediate reply this msg to CG 2d Inf Div Ft Lewis with info copy this Hq AITN AMAGP-2."	Classified Personnel File 2d Inf Div Entry #3B
10.	2201	Teletype WAR 85426 fr CS3PO	The following teletype to CIGFECOM from DA 102201 established status of Division: "a. Estimate departure 2d Inf Div starting 19 July and clearing ZI by 10 Aug. Tentative increments for passenger shipping as follows: 2500 19 July, 3000 25 July, 2500 31 July, and balance of Division by 7 August. b. Tvl time Pusan 16 days for passenger shipping; c. shipping available not of proper type for efficient combat loading. Use of combat loading for 2d Division of one RCT would delay shipment of Div 5 days. Combat loading of one Bn uses shipping sufficient for moving 2 Bns by unit loading. Very little amphibious type shipping available for this move. Pers shipping available is not amphibious type, therefore, unit loading is being used to use personnel capacity to maximum. Sufficient cargo shipping is available. d. No convoys are being used. Unit loaded shipments will depart when loaded. Unit loading in this respect means personnel will travel on the same ship with their own equipment in so far as possible. Balance of equip and accompanying supplies will ride on cargo shipping loaded for selective discharge to match unit. You will be notified by the Port prior to departure of specific loading	Classified Movement File 2d Inf Div Entry #9

SECRET

SECRET

HEADQUARTERS SECOND INFANTRY DIVISION
WAR DIARY

100001 July 50 - 102400 July 50 Continued:

Entry No.	Time of Action	Authority	Action	Ref
-----------	----------------	-----------	--------	-----

Entry 10 Continued:

of heavy lifts that cannot be handled by ships gear. If troops can be made available prior to above dates arrangements with port by Second Division may improve schedule of ships. In some cases movements are expected in which naval type amphibious shipping will not be available in quantity for movement of this Division to improve ability to combat load. In order that the Div be moved to FECOM as expeditiously as possible, unit loading will be used until further advise fr Commander in Chief Far East."

11.

2228

Msg DA to
CG 6th Army
WAR 85433

Shipping critera and personnel status changed:

"1. WAR 85614 changed as fols: Units will be shipped with pers curr asgnd meeting criteria est ref radio except as indicated below:

a. Off w/3 months or more remaining to serve in present category upon arrival POE and enl pers w/3 months or more svc remaining upon arrival POE are eligible for shpmt.

b. Auth to cancel PCS orders affecting key off and enl pers of 2d Inf Div who have not left vic of Ft Lewis in compliance w/such orders is delegated to the CG 2d Inf Div. Rept by Ltr, name, rank, branch and serial number of pers affected."

Classified
Pers File
2d Inf Div
Entry #5

12.

Telecon
Col Epley
2d Div G-2
Col Hein
6th Army

The question of attachment of the 2d CIC and augmentation of the Division with OB, PI, and translator teams discussed as well as a supply of informational material on Korea (JANIS).

Colonel Hein indicated that the question of the 2d CIC was being considered and efforts made to fill the unit. As for augmentation of the Division with OB, PI, and Interpreter teams they were in accord but might find it necessary to draw on Fort Reilly to furnish the personnel such as PI, CB, OB and interrogator teams BB as reinforced by the BA type in accordance with T/O & E 30-600.

Janis's, Maps, are to be flown to the Division however not in quantities outlined in tables.

Orientation pamphlets apparently not available.

SECRET

SECRET

HEADQUARTERS SECOND INFANTRY DIVISION
WAR DIARY

100001 July 50 - 102400 July 50 Continued:

Entry No	Time of Action	Authority	Action	Ref																				
13		GO 27, Hq 2d Inf Div 10 July 50	The fol units relieved fr atchmt ind and atchd to 6006 ASU (POC) effective 0001 hrs <table border="1"> <thead> <tr> <th>Unit</th> <th>Atchmt</th> <th>Unit</th> <th>Atchmt</th> </tr> </thead> <tbody> <tr> <td>21st Army Band</td> <td>23d Inf</td> <td>205 Sig Rep Co</td> <td>2d Sig Co</td> </tr> <tr> <td>546 Engr Slt Maint Det</td> <td>2d Engr C Bn</td> <td>590 Sig Const Co</td> <td>2d Sig Co</td> </tr> <tr> <td>1st Mbl Army Surg Hosp</td> <td>2d Med Bn</td> <td>593 Sig Opn Co</td> <td>2d Sig Co</td> </tr> <tr> <td>51st AFU</td> <td>2d Repl Co</td> <td></td> <td></td> </tr> </tbody> </table>	Unit	Atchmt	Unit	Atchmt	21st Army Band	23d Inf	205 Sig Rep Co	2d Sig Co	546 Engr Slt Maint Det	2d Engr C Bn	590 Sig Const Co	2d Sig Co	1st Mbl Army Surg Hosp	2d Med Bn	593 Sig Opn Co	2d Sig Co	51st AFU	2d Repl Co			General Order File Entry #2
Unit	Atchmt	Unit	Atchmt																					
21st Army Band	23d Inf	205 Sig Rep Co	2d Sig Co																					
546 Engr Slt Maint Det	2d Engr C Bn	590 Sig Const Co	2d Sig Co																					
1st Mbl Army Surg Hosp	2d Med Bn	593 Sig Opn Co	2d Sig Co																					
51st AFU	2d Repl Co																							
14	GO 28, Hq 2d Inf Div 10 July 50	Lieutenant Colonel Jack L. Grubb O21180, Ordnance, 702d Ord Main Co, is announced as Ord Off, 2d Inf Div, vice Lt Col James F. Harris Jr, O34242, Ord, 702d Ord Main Co relieved.		General Order File Entry #3																				

Entry No	Time of Action	Authority	Action	Ref																																																																																										
15	Tentative List Available Ships	Tentative list of ships available received:	<table border="1"> <thead> <tr> <th>Ship</th> <th>ETA</th> <th>Unit</th> <th>Type</th> <th>Pers Capacity</th> </tr> </thead> <tbody> <tr> <td>USNS Gen M. M. Patrick</td> <td>14 Jul</td> <td>----</td> <td>AP 150-C4</td> <td>*1526</td> </tr> <tr> <td>USNS James O'Hara</td> <td>2 Aug</td> <td>----</td> <td>AP 179-C3</td> <td>1000</td> </tr> <tr> <td>USNS Frederick Funston</td> <td>20 Jul</td> <td>50AA</td> <td>AP 178-C3</td> <td>1000</td> </tr> <tr> <td>USNS Gen H. B. Freeman</td> <td>21 Jul</td> <td>68AA</td> <td>AP 143-C4</td> <td>2000</td> </tr> <tr> <td>USS Gen W. A. Mann</td> <td>18 Jul</td> <td>2d</td> <td>AP 112-P2</td> <td>2000</td> </tr> <tr> <td>USNS Gen C. G. Morton</td> <td>18 Jul</td> <td>2d</td> <td>AP 138-C4</td> <td>----</td> </tr> <tr> <td>USS Gen J. C. Breckenridge</td> <td>31 Jul</td> <td>2d</td> <td>AP 176-P2</td> <td>2500</td> </tr> <tr> <td>USNS Pvt Joe P. Martinez</td> <td>3 Aug</td> <td>2d</td> <td>AP 187-VC-2</td> <td>1500</td> </tr> <tr> <td>USNS Gen S. D. Sturgis</td> <td>5 Aug</td> <td>2d</td> <td>AP 137-C4</td> <td>1940</td> </tr> <tr> <td>USNS Gen M. B. Stewart</td> <td>7 Aug</td> <td>2d</td> <td>AP 140-C4</td> <td>1940</td> </tr> <tr> <td>USNS Gen E. T. Collins</td> <td>3 Aug</td> <td>2d</td> <td>AP 147-C4</td> <td>2000</td> </tr> <tr> <td>USNS Gen A. W. Greeley</td> <td>6 Aug</td> <td>2d</td> <td>AP 141-C4</td> <td>1940</td> </tr> <tr> <td>USNS Gen C. C. Ballou</td> <td>16 Aug</td> <td>2d</td> <td>AP 157-C4</td> <td>1940</td> </tr> <tr> <td>USNS Gen Geo M. Randall</td> <td>16 Aug</td> <td>2d</td> <td>AP 115-P2</td> <td>2500</td> </tr> <tr> <td>USS Pres Jackson</td> <td>9 Aug</td> <td>2d</td> <td>APA 18-C3</td> <td>1100</td> </tr> <tr> <td>USS Thomas Jefferson</td> <td>15 Aug</td> <td>2d</td> <td>APA 30-C3</td> <td>1100</td> </tr> <tr> <td>USS Gen Mitchell</td> <td>1 Aug</td> <td>2d</td> <td>APA 114-P2</td> <td>2500</td> </tr> </tbody> </table>	Ship	ETA	Unit	Type	Pers Capacity	USNS Gen M. M. Patrick	14 Jul	----	AP 150-C4	*1526	USNS James O'Hara	2 Aug	----	AP 179-C3	1000	USNS Frederick Funston	20 Jul	50AA	AP 178-C3	1000	USNS Gen H. B. Freeman	21 Jul	68AA	AP 143-C4	2000	USS Gen W. A. Mann	18 Jul	2d	AP 112-P2	2000	USNS Gen C. G. Morton	18 Jul	2d	AP 138-C4	----	USS Gen J. C. Breckenridge	31 Jul	2d	AP 176-P2	2500	USNS Pvt Joe P. Martinez	3 Aug	2d	AP 187-VC-2	1500	USNS Gen S. D. Sturgis	5 Aug	2d	AP 137-C4	1940	USNS Gen M. B. Stewart	7 Aug	2d	AP 140-C4	1940	USNS Gen E. T. Collins	3 Aug	2d	AP 147-C4	2000	USNS Gen A. W. Greeley	6 Aug	2d	AP 141-C4	1940	USNS Gen C. C. Ballou	16 Aug	2d	AP 157-C4	1940	USNS Gen Geo M. Randall	16 Aug	2d	AP 115-P2	2500	USS Pres Jackson	9 Aug	2d	APA 18-C3	1100	USS Thomas Jefferson	15 Aug	2d	APA 30-C3	1100	USS Gen Mitchell	1 Aug	2d	APA 114-P2	2500	Classified Misc File 2d Inf Div Entry #54
Ship	ETA	Unit	Type	Pers Capacity																																																																																										
USNS Gen M. M. Patrick	14 Jul	----	AP 150-C4	*1526																																																																																										
USNS James O'Hara	2 Aug	----	AP 179-C3	1000																																																																																										
USNS Frederick Funston	20 Jul	50AA	AP 178-C3	1000																																																																																										
USNS Gen H. B. Freeman	21 Jul	68AA	AP 143-C4	2000																																																																																										
USS Gen W. A. Mann	18 Jul	2d	AP 112-P2	2000																																																																																										
USNS Gen C. G. Morton	18 Jul	2d	AP 138-C4	----																																																																																										
USS Gen J. C. Breckenridge	31 Jul	2d	AP 176-P2	2500																																																																																										
USNS Pvt Joe P. Martinez	3 Aug	2d	AP 187-VC-2	1500																																																																																										
USNS Gen S. D. Sturgis	5 Aug	2d	AP 137-C4	1940																																																																																										
USNS Gen M. B. Stewart	7 Aug	2d	AP 140-C4	1940																																																																																										
USNS Gen E. T. Collins	3 Aug	2d	AP 147-C4	2000																																																																																										
USNS Gen A. W. Greeley	6 Aug	2d	AP 141-C4	1940																																																																																										
USNS Gen C. C. Ballou	16 Aug	2d	AP 157-C4	1940																																																																																										
USNS Gen Geo M. Randall	16 Aug	2d	AP 115-P2	2500																																																																																										
USS Pres Jackson	9 Aug	2d	APA 18-C3	1100																																																																																										
USS Thomas Jefferson	15 Aug	2d	APA 30-C3	1100																																																																																										
USS Gen Mitchell	1 Aug	2d	APA 114-P2	2500																																																																																										

*2000 w/overload 1526 bunk capacity.

Fred G. Meyer
 FRED G. MEYER,
 Captain, Infantry,
 Division Historian.

SECRET

SECRET

HEADQUARTERS SECOND INFANTRY DIVISION
WAR DIARY

110001 Jul 50 - 112400 Jul 50

Entry No	Time of Action	Authority	Action	Ref
1.	0530	Msg WAR to CG 6th Army 85464	WAR 85464 from G4/G1 signed Witsell TAG. Hq 6th Army instructed to prepare the 2d Division for foreign service and to move the organization from Ft Lewis to SEPOE and from there to Pusan, Korea. This message at the same time established shipment numbers and T/O & E of organizations in movement:	Classified Movement File Entry #9

Unit	T/O & E	Str			Ship No.
		O	WO	EM	
Hq 2d Inf Div	7-1N, 7 Jul 48	52	10	141	2484-A
Adv Det 2d Inf Div		10			2484-AIX
Hq Co 2d Inf Div	7-2N, 7 Jul 48	12	1	176	2484-AAA
Med Det, Div Hq, 2d Inf D	7-2N, 7 Jul 48	11		13	2484-AAA
2d Inf Div Band	20-107N, 22 Dec 47		2	68	2484-B
2d Signal Co	11-7N, 3 May 48	11	4	354	2484-C
2d MP Co	19-27N, 11 May 48	7		180	2484-D
702 Ord Main Co	9-8N, 5 May 48	11	8	302	2484-E
2d QM Co	10-17N, 30 Apr 48	11	1	240	2484-F
2d Rcn Co	17-57N, 25 Jun 48	6	1	164	2484-G
2d Repl Co	20-7N, 3 May 48	6	1	34	2484-H
Ninth Inf Regt	7-11N, 21 Apr 48	153	26	3614	2484-J
23d Inf Regt	7-11N, 21 Apr 48	153	26	3614	2484-K
38th Inf Regt	7-11N, 21 Apr 48	153	26	3614	2484-L
Hq & Hq Btry, 2d Div Arty	6-10-1N, 26 May 48	24	3	132	2484-M
Med Det, 2d Div Arty	6-10-1N, 26 May 48	7		63	2484-MM
503 FA Bn	6-335N, 12 May 48	35	7	624	2484-N
15 FA Bn	6-25N, 21 Apr 48	46	7	621	2484-P
37 FA Bn	6-25N, 21 Apr 48	46	7	621	2484-R
38 FA Bn	6-25N, 21 Apr 48	46	7	621	2484-S
82 AAA Wpn Bn	44-75N, 28 Apr 48	36	7	735	2484-T
2d Engr Combat Bn	5-15N, 3 May 48	41	9	927	2484-U
72 Tk Bn (Medium)	17-35N, 23 Apr 48	36	8	640	2484-W
2d Med Bn	8-15N, 27 Feb 48	46	2	293	2484-Y

This to be a PCS. Provisions of SR 55-720-1 and WD Pamphlet 29-11 applicable.

SR 52-20-2 and T/A 21 (PEACE) apply to T/O & E. Attention called to provisions of WAR 85361, 10 Jul 50 for supplementary authorizations and instruction on supply. Units are to move in Category I as cited paragraph 10, SR 55-720-1 w/except that group vehicles will be taken.

SECRET

SECRET

HEADQUARTERS SECOND INFANTRY DIVISION
WAR DIARY

110001 Jul 50 - 112400 Jul 50 Continued

Entry No	Time of Action	Authority	Action	Ref
Entry 1 Continued:				
Units are to be ready for mvmt by 19 July and arrangements made for shipment of pers and equip so as to initiate loading at Port on 20 July. This mvmt will be directed on call of Port Commander SEPCE. Dir communication to facilitate loading authorized. Movement to Port to be by common carrier and/or military carrier.				
The Adv Party shipment 2484-AIX is to report to PAE Fairfield-Suisun, AFB on 21 July for transportation by air to Japan.				
Equipment to accompany units to be marked: TO: Port Trans Off SEPCE, FOR: 2484 (ltr as app) TAT.				
2.	0551	TWX CINCPAC to DA	"Cite CX 57634 for CSGPO. Concur with 2 85426 of 10 July. Send increments soon as possible, destination, Pusan.	Classified Mvmt File Entry #8A 2d Inf Div
3.	0640	Msg CG 6th Army to C/S USA AMGEBI 07146	In conjunction with previous efforts to organize the intelligence section of the 2d Div the 6th Army sent the fol msg to the C/S of USA: "Req immediate consideration be given to activation of the fol MI Orgns and asgd to 2d Inf Div: 1 PI Team (Type CF), 1 OB Team (Type CB), 1 Interrogator Team (Type BB and BA).	Classified Pers File Entry #8 2d Inf Div
4.	1000	Transcript Telecon Gen Fenton Jacobs Gen Keiser	The existing status on ships being altered. Information concerning seven (7) V ships was incorrect. The 2d Div is to be allocated five (5) victories available on 21 July, ten (10) on 25 July, three (3) others which can be made available on 13 July, 14 July, and 18 July. In addition there is one V set-up for Fort Worden for the 13th of July which because of a loading date of 29 July could be diverted to the 2d Div. General Davidson avers it will be possible to get a "firm" list. The existing list is supposed to be a "firm" list now in from Washington. It is possible that the General Patrick scheduled to sail Friday with 1500 Casuals will be consigned to the 2d Div as information indicates possibility of this pers being utilized as filler personnel for the 2d Div rather than to ship them inadequately equipped. General Davidson is confirming this information with Washington.	Classified Misc File 2d Inf Div Entry #8

SECRET

SECRET

HEADQUARTERS SECOND INFANTRY DIVISION
WAR DIARY

110001 Jul 50 - 112400 Jul 50 Continued

Entry No	Time of Action	Authority	Action	Ref
5.	1100	Unit CO's & Staff Meeting 11 Jul 50	<p>Entry 4 Continued:</p> <p>The vessels previously set-up are considered firm with the addition of two (2) ships; one (1) the General Morton capacity 2,000 for 18 July; two (2) the General Mitchell capacity 2,500 for 1 August. In addition the V's indicated above are assigned for movement of tanks, heavy equipment, etc.</p> <p>MSTS question adviseability of permitting unit to move with gasoline and ammunition.</p> <p>Colonel Tully, C/S, Colonel Burgess, G-4, and another officer to go to SEPCE at approximately 1400 hours to discuss loading problems and tentative movement plans.</p> <p>Minutes of Unit Commander's and Staff Meeting:</p> <p>General Keiser:</p> <ol style="list-style-type: none">9th Infantry target date 17 July 1950.Colonel, Tully, Colonel Burgess and Major Hoffman have gone to port to clarify loading.Post property and special service equipment to be left in buildings and accurate lists prepared.Flame throwers though not in T/O & E will be taken; quantity to be taken announced later.CG will talk to 9th and other units prior to their departure. <p>G-1:</p> <ol style="list-style-type: none">Levies to be made of other non-alerted units. Transfers by numbers.21st Army Band to be all colored.Lt Surka to be contacted on proper disposition of records not desired.PCS orders can be cancelled on all personnel still on orders.No curfew in effect as yet.Personnel contacting Red Cross need letter of authorization from CO.PCR check lists being prepared.Deferments by the book, pregnancy of wife not considered valid reason.Obtain lists of personnel requiring two (2) months advance pay. <p>G-2:</p> <p>Information on Korea will be given aboard ship.</p>	Classified Staff Conf File Entry #1

SECRET

SECRET

HEADQUARTERS SECOND INFANTRY DIVISION
WAR DIARY

110001 Jul 50 - 112400 Jul 50 Continued

Entry No	Time of Action	Authority	Action	Ref
			Entry 5 Continued:	
			G-3:	
			1. Existing tactical SOP still operative.	
			2. 12th last night alerted units to pull guard.	
			3. All personnel should be qualified to operate flame thrower.	
			4. Training will be given on 3.5 inch rocket launcher at Fort Lewis.	
			5. Alerted units requested to turn-in training aids.	
			G-4:	
			1. Dull finish may be put on helmets. Decals remain as is.	
			2. Shoe shop to be operated on 24 hour service.	
			3. Meeting of TQM's at Bldg 2570 at 1600 hours.	
			4. Abuses or signal requisitions for spare parts noted.	
			5. QM requisitions to be under T/A 21 Zone 4.	
			6. Packing crate requests not yet submitted by some units.	
			7. Club property:	
			a. Unit trophies - prepare list put in one room call TC to place in storage.	
			b. Now installed equipment can be disposed of by regulation.	
			c. Day room equipment remain in place. Unit fund purchased items will remain in dayroom for turn-over to special service.	
			TC:	
			1. Commendation for 72d tank.	
			Signal:	
			1. Batteries on hand to be turned-in. New batteries to be issued.	
			2. List of signal equipment unserviceable and short to be submitted.	
			JA:	
			Units to take action for release of prisoners.	
			Ordnance:	
			1. 57's not available.	
			2. Answer 12th on mortars.	
			3. 30's and 50's to be replaced.	
			AG:	
			APQ number to be established 12th.	

SECRET

HEADQUARTERS SECOND INFANTRY DIVISION
WAR DIARY

110001 Jul 50 - 112400 Jul 50 Continued

Entry No	Time of Action	Authority	Action	Ref
6.	1900	Msg Ft Monmouth to CG 2d Inf Div SGCSS-T3-57	"CSIGO Attn SIGET-3: Chief of Army Field Forces Remsg WAR 85348 From AGPA-3, signed Witsell TAG. 3 officers seven enlisted stu DS the Sig Sch from your orgn being rtn as dir. Expected time of departure 12 July 1950."	Classified Pers Files 2d Inf Div Entry #9
7.	2038	TWX DA to CG 6th 85538	"WAR 85538 from CSGPO. Your 100624Z of 10 Jul is subj. WAR 85426 of 10 Jul and CX 57634 of 11 Jul furnish basis for loading of 2d Inf Div for reasons indicated. Reply concerning PCS orders furnished by WAR X35433 of 10 July.	Classified Mvmt File 2d Inf Div Entry # 8B
8.	2156	Msg CG 6th Army to CG 2d Inf AMDCG 0705	Instructions received from CG 6th Army reference disposition of fillers, freezing of personnel, and loading: "following information received from CSGPO Bolte: Fillers will be shipped. Ft Lewis in lieu Ft Lawton and every effort will be made to insure they will arrive before 21 July 50. Ref freezing pers G-1 issuing authority to unit commanders concerned to cancel PCS orders of Key Officers and enlisted pers physically present. Units will be shipped unit load not combat load."	Classified Personnel File 2d Inf Div Entry #7
9.	2245	Msg CG 2d Div to CG 6th Army AMBCG 7-227	The following message transmitted fr General Keiser to General Wedemeyer CG Sixth Army, PSF, Calif at 112245 on progress of preparation for movement of 2d Div: "Personal Keiser to Wedemeyer. This is AMBCG 7-227. Satisfactory progress made on all alerted units. Believe target dates can be made but not earlier. All tanks, pers, and equip at Yakima now closed Ft Lewis. My message AMBCG 7-202,"re est unit strengths to be shipped furn Lawton Collins at McChord Fld this morning. Unable to see him personally because all VIP's on plane left orders not to be awakened or disturbed. Gave copy of my msg referred above to Colonel Larsen's aide. Key staff officers now in conf with Jacobs at SEPOE on shipping. Pass to you as idea that 4th RCT now remaining contains sufficient cadre to reactivate a new inf regt on receipt of fillers. Hayden suggests mvmt 519 AAA Gun Bn 120mm at present str to Richland in order to increase effectiveness of def. I do not see necessity therefor at this immediate date and have recommended no action thereon. UR decisions and assistance UR staff have been great help and encouragement. Thanks."	Classified Movement File 2d Inf Div Entry #10

SECRET

SECRET

HEADQUARTERS SECOND INFANTRY DIVISION
WAR DIARY

110001 Jul 50 - 112400 Jul 50 Continued

Entry No	Time of Action	Authority	Action	Ref
10.	2333	Msg CG 6th Army to CG 2d Div relay of WAR 85442	Movement by air of 10 officers as previously directed in WAR 85442 confirmed by CG 6th Army, PSF: "Fol msg dtd 102300 rec from CSGPO Dept Ar Action CINCPAC info Army 2, 3, 4, 6 and Chief AFF WAR 85442. 10 officers from 2d Inf Div will be moved by air to Japan in advance of water movement. These rep will have info on status of equipment and personnel in unit which will be shipped. In addition 1 officer from each of the following units will proceed water movement respective units for same purpose: 70, 73 and 6 Tank Bn; 50, 68, 78, and 15 AAA Bns; and Second ESB."	Classified Mvmt File 2d Inf Div Entry #11
11.		GO 29, Hq 2d Inf Div	Effective 0001 hrs 17 Jul 1950, Hq Sp Trps (Prov) orgn by GO 66, Hq 2d Inf Div Fort Lewis, Wash, 29 Nov 49 discontinued. Elt of Hq 2d Inf Div and the 2d Inf Div Band, Med Det, 2d Inf Div atchd to Hq Co, 2d Inf Div, eff 0001 hrs 17 Jul 50 for pers and adm. Sp Trps athletic association property and funds: a. 13th QM Bn to assume resp for bldg 4137 and all property of association therein. b. 514th Trans Trk Co to assume resp for bldg 2612 and all prop of association therein. c. Surplus funds to be converted to a US Treasury Check payable to the Custodian Special Trps Ath Association Fund, 2d Inf Div and deliver to the Hq Commandant, 2d Inf Div.	GO File 2d Inf Div Entry #4

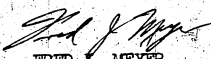
FRED J. MEYER,
Captain, Infantry,
Division Historian.

SECRET

SECRET

HEADQUARTERS SECOND INFANTRY DIVISION
WAR DIARY

120001 Jul 50 - 122400 Jul 50

Entry No	Time of Action	Authority	Action	Ref
1.	0403	Msg WAR to CG 6th Army #85654	Per prior request the 2d CIC Detachment added to shipping list of 2d Inf Div: Shpmt 2484-BB T/O & E 30-500, 15 Sep. 48. Str 4 Off, 5 WO, 8 EM.	Classified Mvmt File 2d Inf Div Entry #9A
2.		Ltr Hq 2d Inf Div AMBGC 370.5	In conjunction with Msg WAR 85464 which established shipment numbers, T/O & E's, and strs for 2d Div units 0530 11 July, the initial 2d Div movement order was published further amplifying method of establishing shipping numbers and outlining procedure to be followed in the forthcoming movement. This order covered such factors as: 1. Preparation for overseas movement, security of movement, allowances of clothing and equipment, movement (method), specific instructions relative to shipment (e.g. marking of clothing, uniform for embarkation), miscellaneous instructions (e.g. APO procedure, limitation on direct port contacts, status of EM to accompany units, application of POR qualifications with disposition of unqualified, compassionate deferments, req for personnel, AWOL's and disposition, pre-embarkation leaves, limitation on dock-side visits of dependents and friends.)	Classified Mvmt File 2d Inf Div Entry # 16
3.		Transcript Telecon Col Walsh Gen Keiser	Colonel Walsh called in referendé to 2d Div carrying both 2.36 and 3.5 rocket launchers and General Keiser indicated possession of a TWX fr the DA directing that this be accomplished. However General Keiser stated that he would make a further check on this matter.	Classified Misc File 2d Inf Div Entry #17
4.	1100	Minutes of Staff Conf	General Keiser: <ol style="list-style-type: none"> Colonel Hill arrived will command 9th RCT. 6th Army pers here to assist on shipment. Division morale high. Curfew and bed checks will be initiated only when necessary. Vehicle and tank maintenance not too good, necessary this be top equipment, replacement equipment will be taken from here. General desirous of talking to each group prior to departure. C/S: <ol style="list-style-type: none"> Must have confidence in each other, replacements to be cross section of personnel. 	Classified Staff Conf File 2d Div Entry #2

SECRET

SECRET

HEADQUARTERS SECOND INFANTRY DIVISION
WAR DIARY

120001 Jul 50 - 122400 Jul 50 Continued

Entry No	Time of Action	Authority	Action	Ref
			Entry 4 Continued:	
			2. Tentative sailing list set up. 1st priority is 9th RCT, next 68th AAA, 23d, 38th, then Div Arty. Moving by unit loading, requires specifying what is wanted on each ship, port will join this up.	
			3. Units will have to do some of their own POR'g.	
			4. Loading, strength, reporting times, etc., is SECRET.	
		G-1:	1. Replacements from Fort Lawton coming in for 9th RCT.	
			2. Others expected and will be trfd to units by priority.	
		G-2:	1. Aggressor uniforms to be turned in to QM.	
			2. 2d CIC Det., will accompany Div, broken down by RCT's.	
			3. Cameras - no restriction on use.	
			4. Advance shipment maps should arrive today.	
			5. Commerical photographers. No restriction except information; PIO media for dissemination of information.	
			6. Wives should not speculate or disclose information.	
		G-3:	1. Task organization - downgraded to restricted.	
			2. Embarkation orders out PM will show strength figures.	
			3. Attachments go to RCT and not vice-versa.	
		G-4:	1. Furniture purchased by unit funds goes to Post Fund.	
			2. Division TQM req list by Friday 1200 from Tech Svcs - 60 days supply tonnage and cubage.	
			3. Vehicle markings to be covered with water paint.	
			4. Division patches will not be removed from uniforms. (Not to be worn on EBT's)	
		Director of Logistics:	1. 5 tons now possible load limit at ports.	
			2. Clothing will be issued as requested up to allowance and finance office will charge to individual - clothing store open Saturday and evenings.	
		DPC:	Fort Lewis post staff starts functioning today.	

SECRET

SECRET

HEADQUARTERS SECOND INFANTRY DIVISION
WAR DIARY

120001 Jul 50 - 122400 Jul 50 Continued

Entry No	Time of Action	Authority	Action	Ref
5.		Ltr Hq Ar Mat Command, DA Ln Office, TSM&F, subj: Spares for L-16 Aircraft.	Letter received reference "Spares for L-16 Aircraft". "1. This office has received information that there is a possibility that the Second Infantry Division would be sending L-16 aircraft with the troops to the Far East. 2. In-as-much-as there is presently no stock of spare parts for the L-16 aircraft in the Far East it is suggested that if the Division units are to take L-16 aircraft with them, a list be forwarded to this office indicating what peculiar spare parts for L-16 aircraft are being taken by units of the Second Division and what further spare parts will be needed to complete a Table II level of spare parts for the L-16. 3. In order to give this office as much time as possible to work on the supply of additional needed spare parts, it is requested that reply be airmailed as expeditiously as possible. 4. In the event that the L-16 aircraft are not to accompany troops request this office be notified. /s/ Harry T. Shiveley, Major, FA, DA Ln O, AMC."	Classified Supply & Equip File 2d Div Entry #12
6.		GO 1, Hq Fort Lewis, Wash.	The consolidation of Hq Fort Lewis and Hq 2d Inf Div, as announced by para II, GO 65, Hq 2d Inf Div, 16 Nov 49, discontinued effective 0001 hours 12 July 1950. All matters pertaining to other than the 2d Inf Div or other alerted units to be referred to the CG, Hq Ft Lewis, Washington.	
7.	2025	Msg CG 2d Div to Sacramento Sig Depot AMNLE-S07-148	Information on priority of movements of elements of 2d Div transmitted to Sacramento Signal Depot, Sacramento, California. "Info avail here for priority of movement elements 2d Inf Div as fol: 9th RCT, 68AAA, 10th Gp AAA, 508th AAA Cpn Det, is 18 Jul 50. 78th AAA Gn Bn, 10th AAA AWSE, 14th RMU is 1 Aug 50. 38th RCT is 3-5 Aug 50. 35th RCT is 31 Jul thru 1 Aug 50."	Classified Mvmt File, 2d Inf Div Entry #13

Fred J. Meyer
FRED J. MEYER,
Captain, Infantry,
Division Historian.

SECRET

HEADQUARTERS SECOND INFANTRY DIVISION
WAR DIARY

130001 Jul 50 - 132400 Jul 50

Entry No	Time of Action	Authority	Action	Ref
1.	0023	Msg WAR to CG 2d Div #85794	Message received from WAR to the effect that the 2d Div "authorized to hold any offs presently under reasg orders but who had not yet departed. Submit pers in this cat by name, para, and DA SO and action will be taken to revoke present orders." The message further indicated that 80 officers presently on orders would be revoked to include: Lt Col D. M. Mc Mains, Lt Col John R. Hector, Lt Col John H. Van Vliet, Lt Col James H. Skeldon, Colonel George B. Paploe, Lt Col James W. Edwards, Lt Col Gerald G. Epley, Colonel Richard Collins Jr., Lt Col Elmore F. Berendt, Lt Col Edwin J. Messinger.	Classified Pers File 2d Inf Div Entry #4D
2.	1100	Minutes Staff Conf	<p>C/S:</p> <ol style="list-style-type: none"> Hospital will continue to give service to families requiring in area. After sailing companies replace regimental insignia. Replacement of equipment is to be taken on sensible basis, not 100% as some units are attempting. <p>G-1:</p> <ol style="list-style-type: none"> 300 colored, 4700 white requisition in to 6th Army. Four (4) ARC personnel on orders to go with Division. All officers and enlisted men in schools being returned immediately to Div. <p>G-3:</p> <p>Individual weapons will be carried, rifle companies will carry crew served weapons, others to be taken on vehicles.</p> <p>G-4:</p> <p>All organizations and technical services to have loading data in by 1200 Sat.</p> <p>DPC:</p> <p>Prior to 25 July list desired of families to be moved from Post.</p>	Classified Staff Conf File 2d Div Entry #3
3.	1500	Msg Inf Ctr Ft Benning to CG 2d Div	"C-47 aircraft due to depart TIS 131100 est ETA Ft Hood 131430 ECST ETA Ft Lewis, 132100 PST. Aboard are 2 3.5 launcher instructional teams of 1 off and 2 EM each for TDY w/ each addressee. Each team accompanied by 6 launchers and 105 rounds ammo. Total weight w/each team 2000 lbs. Rqst preparations be made to unload immediately upon arrival."	Classified Tng File 2d Inf Div Entry #1A
4.	1510	Msg CG Inf Ctr Ft Benning to CG 2d Div, Ft Lewis	Reference status of personnel attending school at Ft Benning: "There are no officers your command presently attending school at this station (Ref WAR 85353). (Ref WAR 85348) 48 enlisted men will depart 13 July 50 and arrive your station 16 July 50 from this school."	Classified Pers File 2d Inf Div Entry # 4C

SECRET

HEADQUARTERS SECOND INFANTRY DIVISION
WAR DIARY

130001 Jul 50 - 132400 Jul 50 Continued

Entry No	Time of Action	Authority	Action	Ref
5.	1520	Transcript Telecon Gen Keiser Gen Davidson	<p>In a conversation with General Davidson on 13 July the problem of the status of Infantry Colonels was discussed. General Keiser indicated his desire to retain all four presently assigned. Colonel Sloane to remain in command of the 9th Infantry and Colonel Hill to command the 9th RCT. This later to be handled by no augmentation of any staff. Colonel Hill also to command the attachments to the 9th RCT. Colonel Freeman who is to arrive in about 10 days or less to take command of the 23d while Colonel Peplow will command the 38th. Even though this will give the Division one extra Colonel it would not be wise to change from Colonel Sloane to Colonel Hill in the 9th Infantry for morale reasons. The problem was further discussed with Colonel D'Orsa and he said that General Clark had been given authority in matters of this nature.</p> <p>General Keiser broached the subject of replacements to be sent from Fort Lawton and General Davidson indicated that the date for shipment had been changed from the 31st to 21st a date which they apparently could not keep. However it is expected they will be in not later than the 31st.</p> <p>Efforts made to clarify status of some 1294 replacements which the 2d Division was to receive from Fort Lawton. General Keiser desired to know if these were a part of the original 5,000 personnel he was to get originally. However General Davidson was not certain of this. It was then decided that it would be better to have replacements come direct to Fort Lewis rather than via Fort Lawton. DA per request of 6th Army concurred in this but some could not be diverted to Fort Lewis immediately as some were already in transit.</p> <p>Difficulties encountered in loading of ships which could disrupt loading plan and schedule. The Navy apparently has decided that ammunition cannot be carried with the troops, and that gasoline cannot be carried in the vehicle tanks or in five gallon cans in the vehicles on the chartered shipping.</p> <p>This apparently applying only to the chartered shipping not the MSTs. This is an extremely important issue as it is imperative that ammunition and gasoline be carried because it is dubious whether these are readily available at destination. It becomes increasingly difficult to comply with the directive on unit loading as these items are required to to with the troops in this type of loading. General Fenton Jacobs is taking the problem up with Washington to try to work it out.</p>	Classified Misc File 2d Inf Div Entry #19

SECRET

HEADQUARTERS SECOND INFANTRY DIVISION
WAR DIARY

130001 Jul 50 - 132400 Jul 50 Continued

Entry No	Time of Action	Authority	Action	Ref
			Entry 5 Continued:	
			Based on the required system of loading, the first RCT being loaded on the 14th of July. The second RCT to commence loading on the 16th. The Division despite this interference proceeding on required system of loading.	
			General Davidson brought up subject of Medical Officers for the Division. However not much progress has been made with the Surgeon General's Office, as a result, General Wedemeyer placed a call to General Ridgeway insisting that the Division have a minimum of 35 and that any less would be unacceptable. It is the desire to provide the difference between the present 17 on hand and the 35 at destination. They intend to utilize this personnel until Division arrives then have them revert to 2d Division. This personnel being air shipped this date presumably to be utilized until division arrival. General Ridgeway has promised to discuss the situation with the Surgeon General and G-1, DA, on the 14th.	
			In conjunction with a previous request the problem of officers in a reserve status desiring to be recalled to active duty rather than volunteer to protect their civilian occupations was discussed. General Keiser indicated that he already had one officer Major William O. Burla, O-1317467 in this status who is a skilled photo-interpreter and desired to have him. General Davidson indicated this was alright.	
6.	1840	Msg CG 6th Army to C/S USA	"Ref Ltr Hq 115 CIC Det Presidio of San Francisco Calif AMGBI-9201 Subj Alert for Overseas Mvmt of CIC pers to Chief CIC dated 23 May 50 and Ltr same Hq, file and subj dated 20 June 50 pertaining alert WOJG Wm H Takshashi USA W904307 FECOM Sep 50 and WOJG Ralph F Mitchell USA W2141165 USFA Oct 50. Rqst PCS orders be issued relieving both Warrant Officers mentioned above from 115 CIC Det PSF Calif with station Ft MacArthur, Calif and assigning them to 2d CIC Det Ft Lewis, Wash with EDCMR earliest possible date in view scheduled overseas movement this unit with 2d Inf Div. Further rqst commercial air transportation be authorized operational necessity. Rqst info this Hq contemplated action earliest. "	Classified Pers File 2d Inf Div Entry #10
7.	1841	Msg CG 6th Army to C/S WDC AMAGP 2-07302.	Msg sent by CG 6th Army to C/S WDC ref revocation of orders of WOJG Warran W. Langston, W 2136569 USA to EUCOM and fur rlyg him fr asgn to 155 CIC PSF and asgn to Second CIC Det, Ft Lewis, Wash.	Classified Pers File Entry #10 2d Inf Div

SECRET

HEADQUARTERS SECOND INFANTRY DIVISION
WAR DIARY

130001 Jul 50 - 132400 Jul 50 Continued

Entry No	Time of Action	Authority	Action	Ref
8.	2206	WAR 85878	The 528 MI Svc Platoon added to list of units to move as part of 2d Inf Div. to CG 6th Army Shipment Number 2484-DD, T/O & E 30-600, dtd 20 Oct 48 (Columns AB, 3BB, BC, BF, BJ), strength 7 officers, 15 enlisted men.	Classified Mvmt File 2d Inf Div Entry # 9B

Fred J. Meyer
FRED J. MEYER,
Captain, Infantry,
Division Historian.

SECRET

140001 Jul 50 - 142400 Jul 50

SECRET
HEADQUARTERS SECOND INFANTRY DIVISION
WAR DIARY

Entry No	Time of Action	Authority	Action	Ref																								
1.	0127	Msg CG 2d Div to CG 6th Army AMBGC 7-188	Tentative shipping strengths of the 2d Infantry Division Units: "Tentative str of RCT 9 follows: 9th Inf 169 off 3250 EM. 15 FA Bn 69 off 600 EM. Company A 2d Engr Bn 6 off 163 EM. Btry A 82 AAA AW Bn 7 off 147 EM. C1r Plat Nr One 2d Medical Bn 9 off 42 EM. Amb Plat Nr 1 Second Med Bn 1 off 22 EM. First Trk Plat Second QM Co 1 off 26 EM. Second MP Co Plat 1 off 33 EM. Bath Unit Second QM Co 4 EM. CIC Det 4 EM. Det 2d Sig Co 15 EM. Adv Det Hq 2d Inf Div 4 off 44 EM. If replacements arrive as promised balance of Div will move at approx T/O & E str."	Classified Pers File 2d Inf Div Entry #13																								
2.	0203	Msg CG 2d Div to CG 6th Army AMBGC 7-187	Tentative sailing list provided to 6th Army as follows: a. 9th RCT, 2d QM (-), 2d Rcn to sail aboard USS Mann, USNS Morton, and USS Patrick. Troops 5317, to commence loading 18 July 50. b. 23d RCT to sail aboard USNS Collins, USS Breckenridge, troops 4949. Loading to commence 30-31 July 50 respectively. c. 38th RCT, 2d Sig (-), 702 Ord to sail aboard USS Mitchell, USNS Martinez, USNS Sturgis. Troops 5692. Start loading 1, 2, 5 Aug 50 respectively. d. 2d Div Arty (-), 2d Engr Bn (-), 2d Med Bn (-), to sail aboard USNS Greeley. Troops 1719. Loading to commence 6 August 1950. e. Hq 2d Div, Hq Co 2d Div, 2d MP Co (-), 2d Repl Co, 2d Div Band, 2d CIC Det (-), 72d Tank Bn (-) to sail aboard USNS Stewart. Troops 533. Loading to commence 7 Aug 50. f. 72 Tank will load tanks and equip on cargo ships during entire period, as shipping becomes available. g. Cargo vessels to be loaded separately as available, by priority of personnel loading.	Classified Mvmt File 2d Inf Div Entry #17																								
3.	0509	Msg CG 2d Div to CG 6th Army AMBGC 7-304	Msg transmitted to CG 6th Army in reference to prior directives governing mvmnt of Adv Party by Air by way of Fairfield-Suisun AFB, California on 21 July 50 listing the following-named personnel duties as indicated:	Classified Mvmt File 2d Inf Div Entry #11A																								
			<table border="0"> <thead> <tr> <th>Name</th> <th>Duty</th> <th>Name</th> <th>Duty</th> </tr> </thead> <tbody> <tr> <td>Brig Gen Joseph S. Bradley & Aide</td> <td>ADC</td> <td>Lt Col Maurice C. Holden</td> <td>G-3</td> </tr> <tr> <td>Lt Col Gerald G. Epley</td> <td>G-2</td> <td>Major Raymond S. Webster</td> <td>G-4</td> </tr> <tr> <td>Major Neil Robinson</td> <td>G-1</td> <td>Capt Edwin C. McLaughlin</td> <td>G-1</td> </tr> <tr> <td>Capt Arthur D. Cunningham</td> <td>G-4</td> <td>Lt William C. Wood</td> <td>G-3</td> </tr> <tr> <td>Lt Malcolm E. MacDonald</td> <td>G-2</td> <td></td> <td></td> </tr> </tbody> </table>	Name	Duty	Name	Duty	Brig Gen Joseph S. Bradley & Aide	ADC	Lt Col Maurice C. Holden	G-3	Lt Col Gerald G. Epley	G-2	Major Raymond S. Webster	G-4	Major Neil Robinson	G-1	Capt Edwin C. McLaughlin	G-1	Capt Arthur D. Cunningham	G-4	Lt William C. Wood	G-3	Lt Malcolm E. MacDonald	G-2			
Name	Duty	Name	Duty																									
Brig Gen Joseph S. Bradley & Aide	ADC	Lt Col Maurice C. Holden	G-3																									
Lt Col Gerald G. Epley	G-2	Major Raymond S. Webster	G-4																									
Major Neil Robinson	G-1	Capt Edwin C. McLaughlin	G-1																									
Capt Arthur D. Cunningham	G-4	Lt William C. Wood	G-3																									
Lt Malcolm E. MacDonald	G-2																											

SECRET

HEADQUARTERS SECOND INFANTRY DIVISION
WAR DIARY

140001 Jul 50 - 142400 Jul 50 Continued

Entry No	Time of Action	Authority	Action	Ref
4.	1020	Transcript Telecon Gen Davidson Gen Keiser	<p>The following extracts from transcript of telecon between General Car Davidson, 6th Army, Presidio of San Francisco and General Keiser included in entirety to indicate status of personnel problems 2d Infantry Division:</p> <p>"Gen Davidson: We have just received instructions from DA that we are not to put any more replacements into the Div until we have made up a package equal to the total that we have already put into the Div from the pipeline. As I understand the picture, that group of 1288 that you got from Fort Lawton the other day have now been assigned to the Division.</p> <p>Gen Keiser: That's correct.</p> <p>Gen Davidson: What we have to do now is to set up a package made up of the next replacements that come to you or Lawton which will be held for further instructions and they plan to air ship them as replacements for General Mac Arthur. They have been promised that they would still fulfill their original promise of the 5,000 not later than 31 July. Evidently what they gave us the other day was a little "gravy" and now they have to "renig" on that because of the demands of the Far East.</p> <p>General Keiser: I see.</p> <p>General Davidson: I told them it would be very helpful if they could give us some indication of when these future replacements will arrive. A G-1 rep was there with G-3 at the DA - first he said they didn't think they could do it, then he said they would do their best to send you, to you direct, information to us, what schedule they expected or hoped to be able to meet with regard to these replacements. I told them if shipping varied we'd still like to know the date on which they were ordered to depart from their present station.</p> <p>I hope that will be forthcoming. I explained the implications of this as I understand it from your point of view, but they say General Mac Arthur's requirements had priority and we'd have to just make up that package and hold them at Fort Lewis and Lawton to the total of what you have put into the Div - total of 1288 - and they would tell us where to ship them for air shipment.</p> <p>General Keiser: I see. OK, now what does the General want us to do in regard to going with the strength as is in both the 23d, 36th, and the other things?</p> <p>General Davidson: Well, you'll have to go ' - - - - -'. The first thing is to get the unit out as fast as possible, as strong as possible, so, just have to go at the strengths the replacements in the near future will permit. That's the best we can do.</p>	Classified Misc File 2d Inf Div Entry #23

SECRET

HEADQUARTERS SECOND INFANTRY DIVISION
WAR DIARY

140001 Jul 50 - 142400 Jul 50 Continued

Entry No	Time of Action	Authority	Action	Ref
			Entry 4 Continued:	
			General Keiser: We wont change any sailing dates, then?	
			General Davidson: Nope! As far as Sloane is concerned, you can keep Sloane unless we are informed to the contrary, and, we do not expect to be. We have informed DA we are going to keep him."	
			In the same conversation the problem of loading gasoline and ammunition on chartered ships which had been previously discussed on the 13th was brought up. General Davidson indicated that he had information the the situation was all "squared away". General Keiser countered: "W're using gas in the gasoline tanks, but not in the five gallon cans. They are going without gas in the cans, but we are taking the gasoline in the tank of the vehicle itself so we can drive it off."	
			Acceptability of Lt Col Carle to replace Col Naimark considered and concurred in by General Keiser.	
			General Davidson brought up problem of 91st Div and other reserve units scheduled to train at Fort Lewis. Problem will be investigated and solution arrived at.	
			Colonel Kergens, IG, 6th Army called General Davidson in regard to possibility of supplying a Det of MP's for TDY who queried General Keiser, who gave his hearty concurrence. General Davidson stated he would work on this.	
			Another 6th Army personnel record checking team being sent to Fort Lewis.	
			Further assurance received from General Davidson on status of Division Medical Officers: "The General (Wedemeyer) took up with General Ridgeway, as I told you last night, the question of the medical officers, and General Ridgeway called him back this morning. He gave his full assurance that the Division would be built up to full T/O & E - 25 additional officers - on the far shore".	
			In conjunction with the welfare problems of the personnel General Davidson indicated that General Wedemeyer had prepared a letter covering this which was being forwarded to the 2d Div in sufficient copies to see that affected personnel receive copies.	

SECRET

HEADQUARTERS SECOND INFANTRY DIVISION
WAR DIARY

140001 Jul 50 - 142400 Jul 50 Continued

Entry No	Time of Action	Authority	Action	Ref
5.	1100	Minutes Staff Conf	<p>General Keiser:</p> <ol style="list-style-type: none"> 1. New officers to be kept in troop units not staff positions. 2. Clarification on dependents moving being prepared. 3. Continue to render support to civilian components in so far as possible. 4. Cash clothing allowance out. <p>G-1:</p> <ol style="list-style-type: none"> 1. Replacements still arriving. 2. Main and North Fort Post Offices to be open Saturday and Sunday. <p>G-2:</p> <ol style="list-style-type: none"> 1. Issue of maps planned. Will be given to CO of troops on ship. 2. Personnel to be alert for sabotage. <p>G-3:</p> <p>Ship board training schedule being prepared.</p> <p>G-4:</p> <ol style="list-style-type: none"> 1. Administrative schedule vehicle support will be published today. 2. Engineer check lists must be in by 1500 this date. <p>G/S:</p> <p>2Sd RCT starts loading out 16 July 50.</p> <p>DPC:</p> <p>Commissary privileges still available to dependents.</p>	Classified Staff Conf File 2d Div Entry #4
6.		Ltr Hq 2d Inf Div, AMBGC 370.5	In conformance with Msg WAR 85378 received this headquarters 13 July 1950 initial Movement Orders, 2d Infantry Division published 12 July 1950 changed to include the 528 MI-Svc Plat, Shipment Number 2484 DD, str 7 off 15 EM, T/O & E 30-600 Columns AB 3 BB, BC, BE, BJ. Division totals revised to read. 914 off 188 WO 17646 EM - aggregate 18729.	Classified Mvmt File 2d Inf Div Entry #16
7.		Ltr Hq 6th Army AMGCT-T 370.5	Confirmation received by letter from Hq 6th Army, PSF, on implementation of instructions contained in WAR 85314, 9 July 50, which announced plans for movement of the 2d Infantry Division to FECOM, WAR 85361, 10 July 50, which supplemented authorizations and instructions on supply, WAR 85464, 11 July 50, which furnished certain supplemental information regarding the movement. It was further directed by the letter that the CG of the 2d Inf Div in conjunction with the CG SEPOE and CO, Fairfield-Suisun, AFB, take appropriate action to facilitate movement of the units of the 2d Div to Pusan, Korea as indicated in Msg WAR 85464.	Classified Mvmt File 2d Inf Div Entry #16A

SECRET
HEADQUARTERS SECOND INFANTRY DIVISION
WAR DIARY

140001 Jul 50 - 142400 Jul 50 Continued

Entry No	Time of Action	Authority	Action	Ref
8.		Embarkation Order #1 2d Inf Div	Embarkation order #1 published and distributed, the 9th RCT to embark on MSTIS shipping during the period 14-18 July 1950 for PCS as directed.	Classified Mvmt File 2d Inf Div Entry #12
9.	1940	Msg CG 2d Div to OCAFF AMBGC 7-311	The information contained in msg to CG 6th Army at 140203 hours of the 14th sailing lists and further qualified the movement by indicating: "Prep proceeding sat. Contemplated completion as scheduled contingent on shipping availability as tentatively scheduled. Three cargo ships started loading equip 9th RCT, 2d QM (-), 2d Recon 14 July;"	Classified Mvmt File 2d Inf Div Entry #18
10.	2003	Msg DA to CG 2d Inf Div WAR 86001	Clarification of status of 523 MI Svc Plat: "WAR 86001 Ft Riley For Com Gen Army Sch Sgd Witsell TAG from G-1 Ur Msg AMGBI 07146 dated 11 Jul 50. 523 MI Svc Plat consisting of colms AB, 3 BB, BC, EF, BD of T/O & E 30-500 dtd 20 Oct 48 is trf less pers and equip from Ft Bragg NC to Ft Lewis, is rel fr asg 3d Army and asg to 6th Army for atch to 2d Inf Div eff 15 Jul 50. Authorized str of unit 7 off 15 AM. Mvmt Directive WAR 85464 dtd 11 Jul 50 being amended to include 523 MI Svc Plat. Are PI and CB Dets req in addition to similar pers included column 7 T/O & E 7-1N dated 7 Jul 48? Information CE Cat pers not available within your resources. All aval Korean Linguist interrogaters or pers being sent FECOM dir.	Classified Pers File 2d Inf Div Entry #10C
11.		GO 30 Hq 2d Inf Div	Brigadier General Joseph E. Bradley, O12428, USA, Hq 2d Inf Div, is announced as Assistant Division Commander, 2d Inf Div, vice Colonel Joseph M. Tully, O4464, GSC, Hq, 2d Inf Div relieved. Captain Sumter R. Nelson, O420240, Inf, Hq, 2d Inf Div, is announced as Hq Commandant, 2d Inf Div.	GO File 2d Inf Div Entry #5

Fred J. Meyer
FRED J. MEYER,
Captain, Infantry,
Division Historian.

SECRET

HEADQUARTERS SECOND INFANTRY DIVISION
WAR DIARY

150001 Jul 50 - 152400 Jul 50

Entry No	Time of Action	Authority	Action	Ref
1.	0416	Msg CG 2d Div to CG 6th Army AMGGC 7-531	Message sent to CG 6th Army relative to status of shipping previously outlined in message AMGGC 7-137 this headquarters as follows: "USS Patrick, Lann, Morton, load and depart 17, 18, 19, respectively. Patrick firm, others tentative. Cargo vessels above shipment now being loaded. Estimated departure cargo vessels 17 Jul."	Classified Mvmt File 2d Inf Div Entry #19
2.		Ltr Hq 6th Army AMGC-T 370.5 (12 Jul 50) Subj: Amendment #1 to Mvmt O, Shpmt 2484.	On this date further confirmation received as an amendment to previous movement instructions issued on 14 July 1950 of the status of the 2d CIC Det (SN 2484-BB, T/O & E 30-500, 15 Sep 48, str 4 off, 5 WO, 8 EM) and 528 MI Svc Platoon (SN 2484 LD, T/O & E 30-600, 20 Oct 48 (Cols AB, 3 BB, EC, EF, EJ)). This initial directive was amended to include these units.	Classified Mvmt File 2d Inf Div Entry 16A
3.	1100	Minutes Staff Conf	C/S: 1. Uniform will still be worn in town. 2. Convoy speeds will be controlled. 3. Equipment must be checked prior to port. G-1: 1. 17 medical officers to be furnished here, 25 at debarkation point, full dental strength. 2. Advance party - company strength. G-2: New Division internal SOP being published. G-3: Tests made with 3.5 rocket launchers, penetrates up to 12-14" steel armor. Use in pairs recommended. M22AL. G-4: 1. Data to TM is due 1200 hours today. 2. Cargo on vehicles must be lashed securely, materials available at engineer supply. 3. Personnel going on cargo ships will carry PX supplies with them. 4. Windshield covers must be taken with units.	Classified Staff Conf File 2d Div Entry #5

SECRET

HEADQUARTERS SECOND INFANTRY DIVISION
WAR DIARY

Entry No	Time of Action	Authority	Action	Ref																																				
4.		Disposition Form fr AG to G/S-15 July 50	<p>"1. The attached letter and inclosures was received as shown, direct from DA. We have not received as yet any information as to when individuals will ship. Number of personnel that DA levied upon the various installations is as follows:</p> <table border="1"> <tbody> <tr> <td>1st Army</td> <td>338</td> <td>2nd Army</td> <td>720</td> <td>3rd Army</td> <td>1039</td> </tr> <tr> <td>4th Army</td> <td>1384</td> <td>5th Army</td> <td>580</td> <td>6th Army</td> <td>715</td> </tr> <tr> <td>C Cml C</td> <td>113</td> <td>MDW</td> <td>166</td> <td>AAA</td> <td>41</td> </tr> <tr> <td>TAG</td> <td>1</td> <td>C of Engrs</td> <td>41</td> <td>SGO</td> <td>24</td> </tr> <tr> <td>C of Trans</td> <td>9</td> <td>C Sig O</td> <td>29</td> <td>C of Ord</td> <td>47</td> </tr> <tr> <td>CGMG</td> <td>22</td> <td colspan="4"><u>TOTAL 5319</u></td> </tr> </tbody> </table>	1st Army	338	2nd Army	720	3rd Army	1039	4th Army	1384	5th Army	580	6th Army	715	C Cml C	113	MDW	166	AAA	41	TAG	1	C of Engrs	41	SGO	24	C of Trans	9	C Sig O	29	C of Ord	47	CGMG	22	<u>TOTAL 5319</u>				Classified Pers File 2d Inf Div Entry #14
1st Army	338	2nd Army	720	3rd Army	1039																																			
4th Army	1384	5th Army	580	6th Army	715																																			
C Cml C	113	MDW	166	AAA	41																																			
TAG	1	C of Engrs	41	SGO	24																																			
C of Trans	9	C Sig O	29	C of Ord	47																																			
CGMG	22	<u>TOTAL 5319</u>																																						

2. These messages were sent out on 11 July and it is doubtful whether any personnel, as a result of these levies, can be received at Fort Lewis prior to 25 July. Thus it is possible that during the last week in July and the 1st week in August we will receive daily huge shipments of enlisted men. Since we have the MOS's of the individuals that were levied, we can and will set up tentative assignments and delivery to the units will be made quite rapidly. There may be, however, a bottleneck in transportation and housing of these personnel. The 4th Infantry area reports an estimated capacity for approximately 1,000 men which may be reduced somewhat due to their receipt of non-POR personnel from alerted infantry units.

3. It is recommended that:

a. All alerted units be appraised of the fact that they may receive unannounced shipments of personnel to bring them up to full T/O during the latter part of July and the 1st week in August.

b. That reception and housing of personnel destined for the 78th and 15th AA Bn (who presumably will be assigned direct to those units on orders) be handled by the CG 31st AAA Brigade.

c. That a battalion portion of the permanent barracks area vacated by the 9th Infantry be tentatively allocated to the 4th RCF to be used as over-flow housing in case of necessity to handle this influx of replacements."

Frederick J. Meyer
 FRED J. MEYER,
 Captain, Infantry,
 Division Historian.

SECRET

HEADQUARTERS SECOND INFANTRY DIVISION
WAR DIARY

160001 Jul 50 - 162400 Jul 50

Entry No	Time of Action	Authority	Action	Ref
1.	0335	Msg CG SEPOE to CG 2d Div TCSEP-TM073	Port call issued for 1st elements of 2d Division to load on USNS M. M. Patrick to arrive shipside Navy Pier J Tacoma, Washington, commencing at 2000 hours 16 July with last elements to embark morning of 17 July 1950.	Classified Mvmt File 2d Inf Div Entry #15
2.		GO 31 Hq 2d Inf Div	General Orders 63, Hq 2d Inf Div, 16 Nov 49 pertaining to announcement of staff rescinded and the following staff Hq 2d Infantry Division announced:	GO File 2d Inf Div Entry #6
		Asst Division Commander	Brig Gen Joseph S. Bradley, 012428, USA	
		Artillery Officer	Brig Gen Loyal M. Haynes, 08379, USA	
		Chief of Staff	Colonel Joseph M. Tully, 04464, GSC	
		AC of S, G-1	Lt Col James D. Tanner, 052132, GSC	
		AC of S, G-2	Lt Col Gerald G. Epley, 018770, GSC	
		AC of S, G-3	Lt Col Maurice C. Holden, 024534, GSC	
		AC of S, G-4	Lt Col Frank C. Sinsel, 028998, GSC	
		Adjutant General	Lt Col Lester W. Teter, 051312, AGD	
		Headquarters Commandant	Capt Sumtner R. Nelson, 0420240, Inf	
		Air Officer	Capt Robert L. Hoffman, 01176669, FA	
		Chaplain	Colonel Edward J. De Mars, 029128, Ch C	
		Chemical Officer	Lt Col Richard O. Gordon, 024440, Cml C	
		Engineer Officer	Lt Col Joe A. McEachern, 039907, CE	
		Finance Officer	Lt Col Orville A. Lesley, 039629, FD	
		Inspector General	Major Herman C. Duvall, 0436250, IGD	
		Judge Advocate	Lt Colonel Burton F. Ellis, 029033, JAGC	
		Ordnance Officer	Lt Col Jack L. Grubb, 021180, Ord	
		Provost Marshall	Major Henry C. Becker, 031944, CMP	
		PIO	Major Cliffrord R. Buckbee, 0324772, Inf	
		JM	Lt Col Arnold C. Gilliam, 051370, QMC	
		Signal	Lt Col Elmore F. Berendt, 0216733, Sig C	
		Special Service Officer	Major Victor E. Strom, 01283163, Inf	
		Surgeon	Lt Col Max Naimark, 019303, MC	
		TI & E Officer	Capt Bernard O. A. Bailey, 01845729, GSC	
		Transportation Officer	Major George H. Huffman, 0494380, GSC	

SECRET
 HEADQUARTERS SECOND INFANTRY DIVISION
 WAR DIARY

160001 Jul 50 - 162400 Jul 50 Continued

Entry No	Time of Action	Authority	Action	Ref
3.		Embarkation Order 2 Hq 2d Inf Div	Embarkation order number 2 published, Hq and Hq Btry, 2d Inf Div Artillery and increments of the 25d RCT (37th FA Bn; Company B, 2d Engr Bn; and Btry B, 82d AAA Av Bn) to embark on MSTs shipping during the period 17-25 July 1950 for PCS as directed.	Classified Mvmt File 2d Inf Div Entry #22
4.		Embarkation Order 3 Hq 2d Inf Div	Embarkation order number 3 published, 25d RCT (-) to embark on MSTs shipping during the period 17-25 July 1950 for PCS as directed.	Classified Mvmt File 2d Inf Div Entry #74
5.		Ltr Hq 2d Inf Div AMGD 370	Loading schedule initiated for movement of elements of the 9th RCT to board the USNS General Patrick commencing 1830 16 July 1950 in serials through 17 July 1950.	Classified Mvmt File 2d Inf Div Entry 14-15
6.		Ltr Hq 2d Inf Div AMGD 370	Instructions published for entrucking of elements of the 9th RCT on the USNS General Morton commencing 1830 hours 17 July 1950 in serials through 18 July 1950.	Classified Mvmt File 2d Inf Div Entry 14-15
7.		Minutes Staff Conf	<p>General Keiser:</p> <ol style="list-style-type: none"> 1. Ltr from General Wedemeyer commendation on review. 2. Loading of some units to start within two weeks. 3. All orders must brief and right to point, but clear and understandable. 4. Except station complement not on war time, but Division, yes. 5. Excess equipment not to be abandoned. Turn into appropriate supply. 6. Make allotments, check insurance. <p>C/S:</p> <ol style="list-style-type: none"> 1. Changes within past 24 hours to be taken up at daily meetings. <p>G-1:</p> <ol style="list-style-type: none"> 1. Everything said in this room is SECRET. 2. All units shoot at T/O & E strength. 3. Men with 3 months to go will go. Men can re-enlist for own job vacancies, may extend. 4. No leaves. 5. POW is changed overseas time makes a difference. 	Classified Staff Conf File 2d Div Entry #6

SECRET

SECRET

HEADQUARTERS SECOND INFANTRY DIVISION
WAR DIARY

160001 Jul 50 - 162400 Jul 50 Continued

Entry No	Time of Action	Authority	Action	Ref
			Entry 7 Continued	
			6. All officers and men at schools will return to Division	
			7. PCS persons will be held if they have not departed Fort Lewis. Mostly field grade officers.	
			8. 5000 replacements due in prior to movement.	
			9. All officers and enlisted men of alerted units move onto post.	
			10. 1-3 months pay. SR 35-1105, married with dependents.	
			11. Serious drive on allotments and insurance.	
			12. Instructions on mail to be announced later.	
			13. All athletic events cancelled.	
			14. Staff and all sections to work seven days a week.	
			15. Request on dog tags to replacement company.	
			16. Administrative support teams coming from 6th Army.	
		G-2:	1. By-weekly conferences for today cancelled.	
			2. Date and destination not to be discussed except in official business.	
		G-3:	1. Basic movement order published.	
			2. Operation orders movement published.	
			3. I & E is cancelled for all alerted elements.	
			4. ROTC support by Division ceases today.	
			5. At 1430 conference room on civilian components meeting.	
			6. Post operations Capt Wheeler will arrange all non-divisional units.	
		G-4:	1. POM inspections will be by units. Tech Sv's will assist units.	
			2. Units submit requisitions for full T/O & E.	
			3. Requisition overseas equipment except pregated equipment.	
			4. Vehicles out of limited storage. Turn in overages.	
			5. Unit trophies (list of each, describe it). Call Post Engr, they will pack and store. Unit may store in vault.	
			6. Day room furniture turn-in slips, leave in day room.	
			7. PCS property should be inventoried. CM will take and schedule turn in.	
			8. Packing and crating is fixing 200 boxes per bn. Give requirements to Post Engr.	
			9. Stencil shop at Post Engineer.	
			10. Regiments and separate battalions will draw banding materials.	
			11. TMM's each regiment, separate battalion, separate companies will submit by 1630 names of unit TMM's to G-4.	

SECRET

HEADQUARTERS SECOND INFANTRY DIVISION
WAR DIARY

160001 Jul 50 - 162400 Jul 50 Continued

Entry No	Time of Action	Authority	Action	Ref
			Entry 7 Continued	
			Director of Logistics:	
			1. Turn in brushes, paint, and tools.	
			2. Get request for packing and crating.	
			3. Two movements packed and crated and stored or move by rail to your home.	
			4. Turn in present overcoats. Same overcoat as we had last winter will be issued. Officers included.	
			Signal:	
			1. Cannot repair any signal equipment. Give pencil list to signal for replacement of any unserviceable equipment.	
			Provost Marshal:	
			1. When can 2d MP Co be relieved from post duty.	
			General Keiser:	
			1. One ship on 17th.	
			2. First CBT move at present level.	
			3. All PCS after 15th is out includes all units.	
			4. Just information.	
			G-3:	
			1. Meeting at 1430 is cancelled.	
			2. 1 officer 2 enlisted men to learn firing of 3.5 rocket launcher leave 13th.	
			General Keiser:	
			1. Change all troops in barracks.	
			C/S:	
			1. Chiefs will settle all accounts as of next Saturday.	
			2. Funds. Change into treasurers checks. Take along.	
			3. Overtime is authorized from now on.	

Fred S. Meyer
FRED S. MEYER,
Captain, Infantry,
Division Historian.

SECRET

SECRET

HEADQUARTERS SECOND INFANTRY DIVISION
WAR DIARY

170001 Jul 50 - 172400 Jul 50

Entry No	Time of Action	Authority	Action	Ref
1.	0100	Msg CG 2d Div to CG 6th Army AMBGC 7-361	Message initiated at 162100 reference revision of ships to be utilized and establishing departure times: "USS Patrick, Sultan, Morton depart 17, 18, 18 Jul respectively. USS Sultan repl USS Mann. From AMBGC 7-361, My Msg seven dash one eight seven and seven dash three three one."	Classified Mvmt File 2d Inf Div Entry #19A
2.	0145	Msg CG 2d Div to OCAFF AMBGC 7-362	In conjunction with amendatory message to 6th Army on status of shipping a report was rendered 161245 July 50 and transmitted 170145 Jul to the OCAFF Fort Monroe, Virginia: "Progress as of 15 Jul satisfactory and on schedule for 2d Div and AAA. Cargo ship Towle completes loading 16 Jul, California started loading 2000 hrs 14 Jul. Third cargo ship due Olympia Wash 17 Jul. Pers loading of 9th RCT, 2d CM, and Second Recon starts 17 Jul aboard Patrick, 18 Jul aboard Sultan (Substitute for Mann) and completes 19 aboard Morton. Remainder no change. AAA schedule follows: 68 Bn trps 805, 11 SMRU trps 4, 10 Gp trps 105, 21 Jul. 78 Bn trps 805, 15 Bn trps 793, 14 SMRU trps 4. No schedule other than readiness date 25 Jul. Aboard personnel carriers; all units have indiv wpns, rifle companies carry crew served wpns plus tng ammo. Arranged with Navy conduct actual firing instr. Rocket team arrived starts instruction 16 Jul. Tng to continue aboard ships. Consider equipment problems will be satisfactorily solved due to all out effort all concerned. Personnel replacement problem critical due to arrival failure from other army areas and other sources. Replacements should be shipped here most expeditious means possible since shipping schedules constantly revised to earlier sailing dates. Rail scheduling and routings should be carefully screened for speedier arrival. Request assistance."	Classified Mvmt File 2d Inf Div Entry #20
3.	0528	MSG JEMPOE to CG 2d Inf Div TCSEP-AMD-77	Port call issued from Seattle POE for unit shipments to arrive shipside USNS Gen C. G. Morton at B Dock Tacoma, Washington, commencing 2000 hours 17 July 1950 with final elements embarking 0800 hours 18 July 50.	Classified Mvmt File 2d Inf Div Entry #15D

SECRET

SECRET

HEADQUARTERS SECOND INFANTRY DIVISION
WAR DIARY

170001 Jul 50 - 172400 Jul 50 Continued

Entry No	Time of Action	Authority	Action	Ref
4.	0600	Msg CG 2d Div to CG 6th Army AMBCG 7-394	Loading of USNS Pvt John R. Towle completed ship to sea with equipment of 9th RCT.	Classified Mvmt File 2d Inf Div Entry #23A
5.	1100	Minutes Staff Conf	<p>General Keiser:</p> <ol style="list-style-type: none"> 1. Control vehicle speeds entirely too fast. 2. General Wedemeyer, CG 6th Army arriving afternoon of 18th to remain through 21st. <p>G-2: Maps being issued.</p> <p>G-3: <ol style="list-style-type: none"> 1. Division Artillery (-) on Hase now plan. 2. Start keeping journals. </p> <p>G-4: <ol style="list-style-type: none"> 1. Individual arms and equipment will not be packed in vehicle personnel coming in will be equipped. 2. Gas and water cans still arriving port empty. Off will check each vehicle prior to departing Fort Lewis. 3. All troop carriers will issue one (1) blanket per EM, cargo ships will enter none. </p> <p>G-1: <ol style="list-style-type: none"> 1. 23d Infantry critical on personnel, possible replacements will arrive 21st. 2. 38th and last units should be in good condition prior to movement. 3. No DA orders being cancelled for non-alerted units. </p> <p>C/S: <ol style="list-style-type: none"> 1. Security of docks - can't be over emphasized. Lids for gas tanks tight. 2. 24 hours prior to departure off and EM to be alerted in unit. </p>	Classified Staff Conf File 2d Div Entry #7
6.	2153	Msg CG 6th Army to CG Ft Lewis AMGCB-T 07144	Confirmation of addition of 528 MI Svc Plat to 2d Div mvmt rec'd: "From AMGCP-T 07144 Ref WAR 85464, 11 Jul 50 and WAR 85878, 13 Jul 50. 528 MI Svc Plat, shpnt Nr 2434-DD, T/O & E 30-600 dtd 20 Oct 49 (Clms AB, 3 BB, BC, BF, BJ) str 7 off 15 EM is added to list units shipped as part of 2d Inf Div."	Classified Mvmt File 2d Inf Div

SECRET

HEADQUARTERS SECOND INFANTRY DIVISION
WAR DIARY

170001 Jul 50 - 172400 Jul 50 Continued

Entry No	Time of Action	Authority	Action	Ref
7.	1600	Msg CG 2d Div to CG 6th Army AMBGC 7-394	Troopship USNS M. M. Patrick (C-4) loaded and departed Tacoma, Washington with following units: 2d Bn 9th RCT, A, B, Btry 15th FA, Hq & Hq Btry and A of 82d AAA, Co A 2d Eng. Troop str: 57 officers 1435 EM Total: 1492.	Classified Mvmt File 2d Inf Div Entry #23A
8.		GO #32 Hq 2d Div	Lieutenant Colonel Donald E. Carle, O20953, Med Corps, Hq 2d Inf Div, is announced as Surgeon, 2d Inf Div, vice Lt Col Max Naimark, O19303, Med Corps, Hq 2d Inf Div relieved.	GO File 2d Inf Div Entry #7
9.		GO #87 Hq 6th Army PSF	Orders published by Hq 6th Army in accordance with provisions of Letter Department of the Army, AGAO-I 322 Gen Res (12 Jul 50) G1-M, 14 July 1950, Subject: "Reorganization of Criteria General Reserve Units", establishing T/O & E's and authorized strengths for 2d Division units.	Classified Misc File 2d Inf Div Entry #40

FRED C. MEYER,
Captain, Infantry,
Division Historian.

SECRET

SECRET

HEADQUARTERS SECOND INFANTRY DIVISION
WAR DIARY

180001 Jul 50 - 182400 Jul 50

Entry No	Time of Action	Authority	Action	Ref
1.	0006	Msg CG SEPOE TCSEP-TMDS7	Instructions received revising units to be shipped on USNS Gen C. G. Morton as indicated on 17th of July Msg TCSEP-TMDS7 fr CG SEPOE. The following amendments are to be noted: "Shpmt 2484-J (Part) 12 off 205 EM embark at 1000 hours 18 Jul 50; shpmts 2484-P (Part) 14 off 212 EM, 2484-F 10 off 180 EM, 2484-G 6 off 164 EM, 2484-J (Part) 28 off 765 EM (Including Med Sec) and 2484-A (Part) 3 off 49 EM, start embarking at 2000 hours 18 Jul 50. Total to embark 73 off 1575 EM.	
2.	0325	Msg CG 2d Div to CG 6th Army AMBGC 7-369	Report submitted to CG 6th Army on status of sailing and loading of USNS Patrick, Morton, and Sultan, USNS General Funston and Freeman, SS Towle Victory. Need for replacement personnel emphasized: "1. Curr sailing dates USNS Patrick, Morton, and Sultan depart 17, 19, and 20 Jul respectively carrying 9th RCT (4827) Second Recon (161) Second QM Co (-) (195). From AMBGC 7-369 My Msg 7-361. 2. Tentative sailing dates for 23d RCT and 2d Div Arty (-) as follows: Funston, Freeman, and Hase 22, 23 and 24 Jul respectively. 3. Towle Victory carrying 9th RCT cargo departed 120600 Jul. 4. Imperative replacements be shipped here by most expeditious means (preferably by air) due to earlier sailing dates."	Classified Mvmt File 2d Inf Div Entry #23
3.	0625	2d Div Load- ing Chart	SS California Victory loaded and to sea with equipment of 9th RCT, 2d Recon, 2d QM.	
4.	1100	Minutes Staff Conf	General Keiser: Gen Wedemeyer will check for four (4) things. a. Status of remaining units. b. Welfare activities. c. Adviseability of continuing organized reserve training at Fort Lewis for balance of summer. d. Status of AAA units at Hanford. G-3: 2d Inf Div to reorganize under N series T/O & E. G-4: 1. Post QM open for business twenty-four hours per day, units to pick up as soon as possible. 2. Units delivering equipment to docks are to leave personnel to see that equipment gets aboard ship in good order.	

SECRET

SECRET

HEADQUARTERS SECOND INFANTRY DIVISION
WAR DIARY

180001 Jul 50 - 182400 Jul 50 Continued

Entry No	Time of Action	Authority	Action	Ref
			Entry 4 Continued:	
			3. Balloons available, 200 per passenger ship, to be drawn from signal sup.	
		G-1:	1. No change in personnel status. 2. No money order facilities but stamps will be available aboard ship.	
		Director of Logistics:	1. Transportation set up for units, call 23100, Division Transportation Officer. Vehicles furnished without drivers. 2. Supply discipline and control not adequate equipment being thrown around promiscuously. 3. Gas cans to be carefully filled and checked for leakage. Guards and personnel dock areas not to smoke.	
		AG:	Efficiency reports should be in prior to sailing.	
		C/S:	Criminal negligence on part of some units on equipment, same mistake will not be allowed again.	
		General Keiser:	Officer in charge of guard will be established at overseas destination. Dumps to be closely guarded.	
5.	1500	Transcript Telecon Gen Davidson Gen Keiser	General Wedemeyer left Hq 6th Army for air transport to Fort Lewis. General Wedemeyer particularly concerned with status of General Reserve Units. DA in process of selecting an engineer battalion for an overseas mission. The one unit in this category at Fort Lewis could be the 6th Engineer Battalion of the 36th Group.	Classified Misc File 2d Inf Div Entry #37

Problem of personnel shortages discussed with General Davidson. They (6th Army) approached DA on granting of authority to take from replacement stream to make up shortages of the 23d Infantry. This was not granted and present instructions stand no more personnel are to be diverted from the pipelines (Lawton or Stoneman). However in this respect DA agreed to query FECOM to determine whether they would prefer replacements as individuals or preferably grant authority to divert a number to bring the 2d Div units closer to T/O & E.

SECRET

SECRET

HEADQUARTERS SECOND INFANTRY DIVISION
WAR DIARY

180001 Jul 50 - 182400 Jul 50 Continued

Entry No	Time of Action	Authority	Action	Ref
			Entry 5 Continued:	
			A decision should be forthcoming morning of 19th. In case this authority should be granted 8th Army is holding back on transportation. The urgency of this problem evident in that some of the rifle units presently average 85 men per company instead of T/O of 205.	
			Without adequate replacements the 23d and 58th will necessarily ship at between 56-57% of T/O strengths counting all elements.	
6.	1930	Msg CG 2d Div to CG Camp Stone-man, Calif. AMBAG 7-382	"This comd alerted for early shpmt to FECOM. Urgently rqst S/R, AP, MPR of pers trfd this comd be dispatched by air mail immediately."	Classified Mvmt File 2d Inf Div Entry #15
7.	2041	Msg WAR to CG 2d Div #86330	1st Lt Lucian K. Truscott III, O27519, Inf, reld fr asgn and dy 3d Army Hq Inf Gen Ft Benning Ga and asgd 2d Inf Div Ft Lewis, Wn for dy as Aide-de-Camp to Brig Gen J. S. Bradley.	Classified Pers File 2d Inf Div Entry #16
8.	2045	Msg CG 2d Div to OCAFF	<p>"1. Visited 2d ESB 17 Jul. Maj problem lack of repl and failure to return 1 EM taking course 17-E-1, 12 EM taking course 17-E-3 from Ft Knox and 1 EM taking course 9E-26 Ord Sch Aberdeen. These 14 key prev trained specl belong 56 Amph Trac and Tank Bn. Total shortage 899 EM exists. Units shipping full T/O & E out of Seattle except for 13 LVT-A and 36 LVT. Above shortages scd for early shpmt to SEPOE. Training to include firing of all wpm by all individuals being carried on. Unit tentatively scd to sail 4-5 Aug. Status considered sat. Anticipate no problems on arrival repl and sch pers. For Halsey from AMBGC 7-386 Lt Col.</p> <p>2. Twitty has rqst through Six Army increase in 162 Ord from 20 to 66 EM and increase in 3M Hq Co from 46-66 EM. Recm approval. Twitty rqst notify you he desires band 1 WO and 22 EM accompany him. For morale purposes consider approval however sit bandmen ZI wide should be determining factor.</p> <p>3. All problems this area resolving themselves contingent upon timely arrival repl which have already been asked for through proper channels. 2d Div repl status</p>	Classified Mvmt File 2d Inf Div Entry #24

SECRET

SECRET

HEADQUARTERS SECOND INFANTRY DIVISION
WAR DIARY

180001 Jul 50 - 182400 Jul 50 Continued:

Entry No	Time of Action	Authority	Action	Ref
----------	----------------	-----------	--------	-----

Entry 8 Continued:

is critical: 9th Inf goes 92% str, 23d Inf at 56% and 38th Inf at 55%. Infantry companies presently average 85 infantrymen short. Strongly recommend use airlift for repl."

9.

2320

Msg CG 2d Div Progress report rendered to OCAFF as of 16 July:
to OCAFF
AMBGC 7-385

- a. Satisfactory and on schedule for 9th RCT and AAA.
- b. ETA USNS Morton moved up to 17 Jul.
- c. Loading 9th RCT will be completed 18 Jul.
- d. Cargo ship Towle completed loading 16 Jul.
- e. California completed loading 17 Jul.
- f. Mormacsun started loading cargo 17 Jul.
- g. Other changes anticipated not firm as of this date.
- h. Arrival of replacements will not materially affect status of 23 and 38 RCT's especially in infantry strength. Urgent to speed up replacements recommend air lift.

Classified
Mvmt File
2d Inf Div
Entry #25

Contained in same msg sit as of 17 Jul:

- a. Towle completed loading 170600, California completed loading 17 Jul, Mormacsun completed 19 Jul, Patrick completed loading 17 Jul, Morton commences loading 18 Jul completes 18 Jul, Sultan ETA now 19 Jul completes loading 20 Jul.
- b. 23 RCT and Div Arty board Funston 21-22 Jul, Freeman 22-23 Jul and Hase 23-24 Jul (Freeman unloading of 68 AAA cancelled and ship given to Second Division).
- c. 38 RCT and remainder of Division load out on Greeley, Collins, Breckenridge 31 Jul and board Mitchell 1 Aug.
- d. 68 AAA, 10 Group, 11 SMRU and 508 Opn Det changed to load 25 Jul aboard Elcko; cargo for AAA loads aboard Guhin 17 Jul and Elko 20 Jul.
- e. Cargo ships Phillipine Bear, Arcadia, and Lipscombe Lykes sed to arrive 18, 19, and 24 Jul respectively to take cargo of 23 RCT, Div Arty, and 38 RCT.

SECRET

SECRET

HEADQUARTERS SECOND INFANTRY DIVISION
WAR DIARY

180001 Jul 50 - 182400 Jul 50 Continued

Entry No	Time of Action	Authority	Action	Ref
10.	2335	Msg CG SEPOB to 2d Inf Div TCSEP TMD104	Port call received directing movement of unit shipments to arrive shipside USNS Gen Daniel I Sultan, Navy Commissioning Pier Tacoma, Washington commencing 1000 hours 19 Jul 50 through 1300 hours 19 Jul 50. Total to embark 131 off and 1977 EM.	Classified Mvmt File 2d Inf Div Entry #15C
11.	2340	Msg CG 6th Army to CG FT Lewis AMGCT-T 07166	"All restrictions on the use of live ammunition in training except as provided for in SR 385-310-1, 4 Mr 49 are hereby rescinded. It is desired that all individuals assigned to combat units be psychologically conditioned for combat. Overhead arty firing and running of the infiltration courses will be conducted if practicable without delaying planned sailing date of units now under movement orders".	Classified Tng File 2d Inf Div Entry #1A
12.		Embarkation Order No 5, Hq 2d Div	Embarkation order number 5 Hq 2d Inf Div published and disseminated indicating the 36th RCT (-) will embark on MSFS shipping during the period 20 July - 4 August for PCS as directed. Projected shipping strengths USNS Stewart 129 off and WO 2523 EM; USNS Collins 117 off and WO 2038 EM.	Classified Mvmt File 2d Inf Div Entry #60

Fred J. Meyer
FRED J. MEYER,
Captain, Infantry,
Division Historian.

SECRET

SECRET

HEADQUARTERS SECOND INFANTRY DIVISION
WAR DIARY

190001 Jul 50 - 192400 Jul 50

Entry No	Time of Action	Authority	Action	Ref
1.	0100	2d Div Loading Chart	USNS Gen C. G. Morton (T-AP 138) loaded and to sea from Tacoma, Washington with the following units: 3d Bn 9th RCT, Sv Co 15th FA, 2d Recon, 2d M. Troop Strength: 68 officers 1437 M - Total: 1505.	Classified Mvmt File 2d Inf Div Entry #72
2.	1100	Minutes Staff Conf	General Keiser: 1. Letter has been written to ships Captains requesting handling of equipment carefully to assist in holding down pilferage. 2. Officers will lose field ration allowances when going aboard ship. G-1: 1. Disregard career guidance, for alerted units is decision made by DA promote to 80% of total authorized strength, promotion will be permanent. 2. APO 243 is new APO for 2d Inf Div, effective now. G-2: 1. Security must be maintained. 2. Communist sympathizers are around and if such personnel are observed report them to CIC or G-2. G-3: 1. Troops going through indoctrination course must wear combat gear. G-4: General Haynes will sub-allocate for vehicles going aboard the Funston only 13 spaces available. DPC: Commissary privileges, club, and post license tags continue in force.	Classified Staff Conf File 2d Div Entry #9
3.		Ltr Hq 2d Div AMBGD 370	Upon receipt of port call from SEPQE embarkation schedule published for personnel of the 9th RCT designated to board the USNS General Sultan, commencing 0845 19 Jul 50 in serials through 1950, 19 Jul 50.	Classified Mvmt File 2d Inf Div Entry #21
4.	2205	MSG CG 2d Div to OCAFF AMBGC 7-393	Progress report submitted to OCAFF, Ft Monroe, Virginia on shipping status of 2d Div units: "1. Progress as of 18 Jul sat and on scd. USNS Patrick and Morton sailed 17 and 19 Jul respectively. Sultan scd depart 19 Jul. Above ships carrying pers and cargo 9th RCT, 2d Recon Co and 2d M Co (-). Cargo ships: Towle departed 17 Jul, Calif departed 18 Jul, Mormacsun due depart 20 Jul. Above carrying cargo of aforementioned units. Some cargo 25 RCT aboard Mormacsun. From AMBGC 7-393.	Classified Mvmt File 2d Inf Div Entry #23

SECRET

SECRET

HEADQUARTERS SECOND INFANTRY DIVISION
WAR DIARY

130001 Jul 50 - 192400 Jul 50 Continued

Entry No	Time of Action	Authority	Action	Ref
			Entry 4 Continued:	
			2. Two cargo ships New World and Arcadia due depart 22 Jul with cargo 23d RCT and Div Arty (-). Above units load pers aboard Funston, Freeman and Hase scd depart 22, 23, and 25 Jul respectively.	
			3. ETA pers ships Greeley, Collins, Breckenridge and Mitchell 29, 30, 30, 31 Jul respectively. Cargo ships Phillipine Bear, Linfield, and Elko ETA 20 Jul. Above will complete outloading of Second Division.	
			4. Pass ship Black ETA 25 Jul will load 10 AAA Gp, 68 Gun Bn, 11 SMRU and 508 Opns Det. Cargo above units loaded Guhin 17 Jul."	
5.	2230	Msg CG 2d Div to CG 6th Army AMBGC 7-394	Report submitted to CG 6th Army, PSF, reference status of shipment covering essentially same information in msg previously transmitted to the OCAF Fort Monroe, VA, at 192205 Jul with the exception that specific times of ship departure given, and current aggregate strengths given:	Classified Mvmt File 2d Inf Div Entry #25A

USNS Patrick	171600	USNS Morton	190100
USNS Sultan	192400 ETD	SS Towle	170600
		SS Calif	180625

23d RCT (3171) 2d Div Arty (-) (888).

Possibility that 1500 casuals might be shipped with the 2d Infantry Division, but not assigned to the Division. This information coming initially from General Brooks in which he stated, "You may divert 1500 casuals from the stream. They are to be attached to the 2d Div for purposes of movement only and not assigned. They must retain their identity and be available for ultimate reassignment at destination. That is General Mac Arthur's command decision". If these personnel are shipped with the 2d Infantry Division the possibility remains that on arrival at destination a goodly number of these replacements might be diverted to the 2d Infantry Division as replacements other than those men with specialists skills which General Mac Arthur's Headquarters would desire to retain or assign.

Chance still remains that personnel will be assigned to the 2d Infantry Division as replacements for the 23d and 38th RCT's. This dependent upon decision from the DA after the group (1350) which were received from Fort Lawton a week ago has been reconstituted. Presently at Ft Lawton only 700 of the 1500 available and of this

SECRET

SECRET

HEADQUARTERS SECOND INFANTRY DIVISION
WAR DIARY

190001 Jul 50 - 192400 Jul 50 Continued

Entry No	Time of Action	Authority	Action	Ref
			Entry 5 Continued:	
			700 120 must be kept constantly alerted for possible air shipment. However by Saturday the possibility exists of there being in excess of 1,000. The system of packaging of this personnel to be left to discretion of the CG, 2d Infantry Division who is to coordinate this with Fort Lawton. CG of Fort Lawton to be instructed by 6th Army to the effect. Casuals from Stoneman not to be considered in this system of packaging as it could not be economical to ship them to Fort Lawton or Lewis as long as shipping is available at San Francisco.	
			To facilitate this program the CG of 6th Army directed that every effort be made to keep the "pipeline" to Fort Lawton full or over-flowing.	
6.		IRS AG to Staff Sect	Projected enlisted shipping strength as of 19 July 1950: Total Division T/O 17797 Pr for Dy 12919 Pending EDCLR 239 Actual 13158 Unit overage 111 shortage 4750. Strength Report attached units: Total Attached 1656 Pr for Dy 1392 Pending EDCMR 15 Actual 1407 Unit Overage 2 Shortage 251.	Classified Pers File 2d Inf Div Entry #22

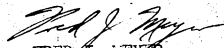
FRED C. MEYER,
Captain, Infantry,
Division Historian.

SECRET

SECRET

HEADQUARTERS SECOND INFANTRY DIVISION
WAR DIARY

20001 Jul 50 - 202400 Jul 50

Entry No	Time of Action	Authority	Action	Ref
1.	0300	2d Div Load-in Chart	USNS Gen D. I. Sultan (P-2) loaded and to sea with the following units: 1st Bn 9th RCF, Hq 15th FA, Platoon 2d MP, 2d Platoon Med, Det Sig, Separate Co's. Troop strength: 136 officers 1837 EM Total: 1973.	Classified Mmnt File 2d Inf Div Entry #72
2.	1100	Minutes Staff Conf	General Wedemeyer: Type of experience personnel may run into in Korea. Can't trust Koreans. Well led, fed, and trained. Make good soldiers. Racial difference will require years to overcome. C/S: Commanding officers of alerted units must report to G-2 office prior to departure for briefing. G-1: 1. 1200 casualties from Fort Lawton to be asgd to 25d Inf and transported with that unit. 2. Helicopter courier starts to Seattle Port 21st, to AG by 1015 hours. Return by 1115 hours there, tel: 28259. 3. Post Office open until 2100 20th, Sat and Sun 0900-1700. 4. 2.36" rocket launchers will be taken by unit. G-2: Reports on Korean linguists not coming in fast enough. Get reports in as soon as possible. G-3: Effectiveness of "3.5" weapon in paper. Disseminate to troops so they will gain confidence. G-4: Open and deliver equipment at once to 23rd and 33th RCT's.	Classified Staff Conf
3.	1210	Transcript Telecon Gen Wedemeyer Gen Davidson	In general transportation improving on dates of availability of shipping making need for replacements to arrive prior to 31st urgent. Organized reserve training to continue at Fort Lewis. General Wedemeyer to speak to the Seattle Advisory Group concerning question of prices being offered personnel for their cars and homes.	Classified Misc File 2d Inf Div Entry #43

SECRET

~~SECRET~~
 HEADQUARTERS SECOND INFANTRY DIVISION
 WAR DIARY

200001 Jul 50 - 202400 Jul 50 Continued

Entry No	Time of Action	Authority	Action	Ref
4.		Ltr CG 2d Div to ADC AMBCG 312.1	<p>Prior to departure for the Far East Command in charge of the Advance Detachment of the 2d Division, Brigadier General J. S. Bradley, ADC, was given the following instructions: "1. As Assistant Division Commander, in my absence you are directed to assume all responsibilities of command over elements of the Division and any attachments thereto, whenever made.</p> <p>2. You will report to CINCFE, or such representatives as he may direct, for instructions relative to employment of the Division.</p> <p>3. a. Although I am confident of the ability of the Division to do a good job either in part or as a whole I insist nevertheless that piecemeal or the task force method of employment be agreed to only in emergency.</p> <p>b. The various elements of combat teams need welding together and physical hardening, a short period to gather their impedimenta together, and a definite shakedown for combat. If possible, coordinated team action of small units with tanks, overhead artillery fire, and weapons firing should be accomplished immediately upon debarkation.</p> <p>4. The need of filler replacements is of paramount importance to the 23d Infantry and 35th Infantry Regimental Combat Teams. Otherwise, they are unfit for any combat as now constituted. Consolidation of units with the attendant breaking up of organizations must be avoided. The heritage of the Division demands that respect.</p> <p>5. Please inform CINCFE of all matters concerning the Division and of the contents of this letter of instructions if desired or necessary.</p> <p>6. You shall be kept informed by radio of any revisions in major personnel organizational strengths as they may occur."</p>	Classified Misc File 2d Inf Div Entry #42
5.	1300		<p>Brigadier General Joseph S. Bradley and a party of (9) officers (listed below) composing the 2d Inf Div adv Party departed Fort Lewis, Washington, at 201300 July 50 for Tacoma, Washington, thence by rail to Fairfield-Suisun, AFB, California:</p> <p>Composition of party: Brigadier General Joseph S. Bradley, ADC, Lt Col Maurice C. Holden, GSC, G-3, Lt Colonel Gerald G. Epley, GSC, AC of S, G-2, Major Neil Robinson, GSC, Ass't, G-1, Major Raymond Webster, Inf, Asst G-4, Captain Edwin C. McLaughlin, AGD, Enls Pers, Captain Arthur Cunningham, Inf, Ass't G-4, 1st Lt William C. Wood, Inf, Ass't G-3, 1st Lt Malcolm MacDonald, Inf, Ass't G-2, 1st Lt Horace R. Smith, Sig Co, Lsg Ctr Chief.</p>	

~~SECRET~~

SECRET
HEADQUARTERS SECOND INFANTRY DIVISION
WAR DIARY

200001 Jul 50 - 202400 Jul 50 Continued

Entry No	Time of Action	Authority	Action	Ref.
6.		Ltr Hq 2d Div ABGOC 370.5	<p>On this date the movement orders published by Hq 2d Infantry Division were further amended and/or changed to include the following:</p> <ol style="list-style-type: none"> 1. Classification of initial directive downgraded to CONFIDENTIAL. 2. Paragraph 4, amended to include the Med Det, 72d Tk Bn, shipment 2434-W, 2 off, 17 EM, aggregate 19, T/O & E 17-35N, 23 Apr 48. Total for 2d Div is now 916 officers, 168 WO, 17663 EM, aggregate 18748. 3. Para 8b changes the shipment number 2434AIX to 2434 AIX. 4. Para 10a, changed to read "APO 243", rather than "APO 2". 	Classified Mvmt File 2d Inf Div Entry #16B
7.	1440	Transcript Telecon Gen Jacobs Gen Keiser	<p>Consent received from Washington to divert the USNS Darby from scheduled run with 1200 casuats for Alaska, to the 2d Division. Units of 2d Division having priority over Alaska. This ship arrived this morning and efforts made to divert the ship and approval received. This substitution for the Hase will enable the 2d Div to get to destination five days sooner.</p> <p>Information received from the DA on the status of replacements and they are ordered in for July. It would be best for the Division to remain long enough to pick these men up rather than ship them as casuats. The 23d and 33th RCT's as far as unit equipment concerned ready to move however the need for replacements still urgent. Efforts being made to coordinate receipt of replacements with shipping. Approximately 3000 replacements expected.</p> <p>Without adequate replacements unit would arrive at destination but not effective necessitating waiting for replacements where with a few days delay they can be picked up in the US at the proper time and in the proper condition.</p>	Classified Misc File 2d Inf Div Entry #44
8.		GO 91 Hq 6th Army, PSF	<p>Second CIC Det rlvd fr attachment to the 115th CIC Det, and atchd to the 2d Inf Div, eff 22 July 1950. (Authority WAR 35654, DA, 12 Jul 50.)</p> <p>The Second CIC Det reorganized under T/O & E 30-500 15 Sep 48 w/c 3, cols AA, BA, w/an auth str of 4 off 5 WO and 8 EM.</p> <p>Announcement is made of the PCS of the following General Reserve Unit, less personnel and equipment, from Fort Bragg, North Carolina, to Fort Lewis, Washington, effective 15 July 1950: 528 MI Svc Plat, T/O & E 30-600 23 Oct 48 cols AB, 3 BB,</p>	

SECRET

HEADQUARTERS SECOND INFANTRY DIVISION
WAR DIARY

200001 Jul 50 - 202400 Jul 50 Continued

Entry No	Time of Action	Authority	Action	Ref
			Entry 8 Continued:	
			BC, BF, BJ, auth str 7 off 15 EM. Effective upon arrival at new station unit was released fr asgn to 3d Army and was asgd to 8th Army w/atchmt to 2d Inf Div, Fort Lewis, Washington. (Auth: WAR 86001, 14 Jul 50.)	
10.	2350	Msg CG 2d Div to CG 6th Army AMBOG 7-408	"Due to impossibility of performing nec phy exams and in accordance w/your instr, pers of alerted units due for early shpmt to FECOM who desired NSLI were auth to submit appl w/o physical examinations. Upon exhaustion of stocks of VA Form 9-350A from local and all other surrounding sources, VA Form 9-350 was utilized. Approx 5000 appl from trps already on high seas or due to depart within next few days were on short form. In view of these facts urgently rqst admin of vets affairs be rqstd to accept the appl heretofore submitted by pers of alerted units at this sta on short form and w/o certificate. Desire assurance that individuals who have submitted ap l and allotments will have insurance in full effect. Upon receipt of long forms stock of which previously exhausted Msg WCL 83503 will be complied with.	Classified Pers File 2d Inf Div Entry #18

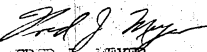
FRED J. MEYER,
Captain, Infantry,
Division Historian.

SECRET

SECRET

HEADQUARTERS SECOND INFANTRY DIVISION
WAR DIARY

210001 Jul 50 - 212400 Jul 50

Entry No	Time of Action	Authority	Action	Ref
1.	1030	Adv Party Journal 2d Inf Div	General Bradley and party arrived Fairfield-Suisun, AFB, California, departed by air (MATS) at 2350 for Hickam AFB.	
2.		Ltr Eq 2d Div ABB&D 370	Loading schedule announced for personnel of the 23d RCT designated to board the USNS General Freeman, commencing at 0730 22 July in serials with last elements to commence loading 1530 hours the same date.	Classified Mvmt File 2d Inf Div Entry #26
3.	1533	Mes SEPOE to CG 6th Army TCSEP TRD 135	Port call received for unit shipments scheduled to arrive shipside USNS Frederick Funston, Navy Pier J, Tacoma, Washington, commencing 0900, 21 July 1950. Total to embark 91 officers 929 EM.	Classified Mvmt File Entry #28
4.	1100	Minutes Staff Conf	G-1: Possible casualties and officers to go as packet. DPC: Personal affairs office set up in AAA units. G-3: Units desiring to train personnel on indoctrination course, contact S-3, 4th RCT. G-4: 1. Controlled items of ammunition 4.2, 75 or 57 recoilless, 90mm HUAP, 3.5 rocket will be shipped direct to FECCM. No basic load. 2. Leaky gas cans noted check still must be completed. 3. Ammunition must be properly loaded.	Classified Staff Conf File 2d Div Entry #11
5.		Transcript Telecon Col Martin Col Tanner	In a call to Colonel Martin, Lt Colonel Tanner, G-1, 2d Inf Div discussed the status of personnel with less than 3 months service remaining. Approximately 1200 personnel presently assigned to the 4th RCT as over strength upon passage of ETS extension bill presently before Congress would become eligible. Based on the certainty of passage it is desired to process this personnel as if they were already available for shipment up to the point of actually leaving the continental US and have them ready if the bill is passed for shipment on the 24th.	Classified Misc File 2d Inf Div Entry #45

SECRET

SECRET

HEADQUARTERS SECOND INFANTRY DIVISION
WAR DIARY

210001 Jul 50 - 21 2400 Jul 50 Continued

Entry No	Time of Action	Authority	Action	Ref
-------------	-------------------	-----------	--------	-----

Entry 5 Continued:

If this were accomplished the problem of replacements for the 23d RCT would be solved and this unit would not have to sail short.

Fred S. Meyer
FRED S. MEYER,
Captain, Infantry,
Division Historian.

SECRET

SECRET

HEADQUARTERS SECOND INFANTRY DIVISION
WAR DIARY

220001 Jul 50 - 222400 Jul 50

Entry No	Time of Action	Authority	Action	Ref
1.	0050	Msg CG 2d Div to CG 6th Army AMBGC 7-480	USNS Frederick Funston (T-AP-138) loaded and departed Tacoma, Washington with following units: Div Arty Hq, 37th FA, B Btry 82d AAA, Co B 2d Engr. Troop strength: 90 officers 933 EM Total 1023.	Classified Mvmt File 2d Inf Div Entry #32
2.	0243	Msg CG SEPOE to CG 6th & Ft Lewis TMD-157	Port call received for personnel scheduled to arrive shipside USNS General H. B. Freeman, Navy Pier J, Tacoma Washington commencing 0900 through 1300 22 July 1950. Total to embark 62 officers 1029 EM.	Classified Mvmt File 2d Inf Div Entry #26
3.	1100	Minutes Staff Conf	G-1: <ol style="list-style-type: none"> No casualties for packets. ETS 15 Aug or less. Any personnel in this category will go; to load on Darby Monday. 800 of 5000 EM to arrive next Friday. Physical deferralment - check over screen closely. 2d Div Surg is the final authority. G-4: All units will furnish 1 fire guard and one security guard per hold on ships while loading.	Classified Staff Conf File 2d Div Entry #12
4.	1807	Msg CG SEPOE to CG Ft Lewis TMD-165	Amendment of Port Call from CG SEPOE. Amends msg TCSEP-TMD 157 dated 22 July 50 to show totals to embark as 91 officers and 1427 enlisted men.	Classified Mvmt File 2d Inf Div Entry #26
5.	2000	Msg CG SEPOE to CG Ft Lewis	The following message received by CG Fort Lewis, Washington relative to shipping of 2d Division units. Extracted: "Part 4. 38 RCT 2 X scd for 3 ves; Gen A. W. Greeley, capacity 221 cabin, 1719 troop scd for embark Tacoma on or about 1 Aug. Gen J. C. Breckenridge, capacity 366 cabin and 2134 troops scd for embark on or about 2 Aug in Tacoma. Gen William Mitchell, capacity 368 cabin and 2134 troop scd for embark on or about 3 Aug in Tacoma. Our info reveals that capacity of these 3 ves exceed aggregate str of unit by 1569 spaces. Rqst you fill in with remainder of 2X so far as possible. Part 5. Gen E. T. Collins will be available on or about 1 Aug to life remainder of 2X.	Classified Mvmt File 2d Inf Div Entry #27

SECRET

SECRET

HEADQUARTERS SECOND INFANTRY DIVISION
WAR DIARY

220001 Jul 50 - 222400 Jul 50 Continued

Entry No	Time of Action	Authority	Action	Ref
			Entry 5 Continued	
			Part 6. On res scd for the 38 RCT 2X rqst SAP the breakdown of units with str figures to be lifted by eac ves. Rqst the same info on the Collins. This info very important to formulate concrete plans."	
6.		Embarkation Order #6 Hq 2d Div	Embarkation order number 6 published and distributed, Div.Hq Co (-), 2d Div Engr Bn (-), 2d Mil Police Co (-), 2d Div Repl Co and 2d Inf Div Band to embark personnel and equip on MSTB shipping during the period 24 Jul - 5 Aug 1950 for PCS as directed. Aggregate personnel strength to ship 2034.	Classified Mvmt File 2d Inf Div Entry #61
7.	2045	Msg CG SEPOE	USNS Gen E. B. Freeman loaded and to sea from Tacoma, Washington with following units: 1st Bn 23d, 2d Bn 23d, 2d Platoon Med, Det Sig, Platoon MP, Separate companies. Troop strength: 98 officers 1431 EM Total: 1524.	Classified Mvmt File 2d Inf Div Entry #56

Fred J. Meyer
 FRED J. MEYER,
 Captain, Infantry,
 Division Historian.

SECRET

SECRET

HEADQUARTERS SECOND INFANTRY DIVISION
WAR DIARY

230001 Jul 50 - 232400 Jul 50

Entry No	Time of Action	Authority	Action	Ref
1.		Ltr Hq 2d Div AMBGD 370	Instructions prepared for the preliminary loading of the 23d RCT on the USNS General Darby. Advance party to commence loading 1800 23 July 1950.	Classified Mvmt File 2d Inf Div Entry #29

Fred C. Meyer
FRED C. MEYER,
Captain, Infantry,
Division Historian.

SECRET

SECRET

HEADQUARTERS SECOND INFANTRY DIVISION
WAR DIARY

240001 Jul 50 - 242400 Jul 50

Entry No	Time of Action	Authority	Action	Ref
1.	0015	Msg SEPOE to CG Ft Lewis	Port call received for loading of USNS Gen W. O. Darby, personnel to arrive ship-side Navy commissioning pier, Tacoma, Washington commencing 1900 23 July with final elements to board 0800 24 Jul 50.	Classified Mvmt File 2d Inf Div Entry #33
2.	0600 1200 2000 2000	2d Div Loading Chart	Arcadia (V) loaded and to sea with equipment of Div Arty, 503d FA, 82d (-), 23d (-). New World (V) loaded and to sea with equipment of 23d RCT, from SEPOE. Linfield (V) loaded and to sea with equipment of 58th RCT. USNS General William O. Darby (P-2) loaded and to sea from Tacoma, Washington with the following units: 3d Bn 23d, Separate Companies 23d. Troop strength 76 officers 1640 EM Total 1716.	Classified Mvmt File 2d Inf Div Entry #72

Fred C. Meyer
FRED C. MEYER,
Captain, Infantry,
Division Historian.

SECRET

HEADQUARTERS SECOND INFANTRY DIVISION
WAR DIARY

250001 Jul 50 - 252400 Jul 50

Entry No	Time of Action	Authority	Action	Ref
1.	0200	Adv Party Journal Gen Bradley	General Bradley's advance party arrived Tokyo (Haneda) airfield and reported in at GHQ, FECOM. Visited GHQ and 8th Army Headquarters establishing a temporary headquarters with G-3 Section, GHQ.	Adv Party Journal
2.		GO #34 Hq 2d Inf Div	1st Lt Lucian Truscott III, 027519, Inf, is announced as Aide-de-Camp to Brigadier General Joseph S. Bradley, USA.	GO File 2d Inf Div Entry #8
3.		Msg CGSFPF to TAG Wash FCSEFP-17260 AG-PO	"The mailing address of 2d Division is still APO 2 according to info in CINCFE msg C57789 sent in answer to WAR 85569. DA msg WAR 86214 asks CINCFE to assign any res APO that has 3 units to Div referred to and says that all Div APOs may soon have their numbers changed. APO 243 has been given to subject Div by CINCFE Msg CX58208. APO in mvmt orders and pas lists is invariably 2. Mail is coming in now for units of this Division some using for address APO 2 and some using 243. Rqst you answer ques is 243 to be used only for money order purposes? Will APO 2 be the only mailing address for the Div?"	Classified Mvmt File 2d Inf Div Entry #58
4.	1100	Minutes Staff Conf	General Keiser: 1. Units should watch personnel closely while loading and until aboard ship. 2. Correct information must be given to dependents. Some misinformation being distributed. G-1: 9th RCT - 200 short 23rd RCT - 650 short 38th RCT - 1600 short C/S: Information going over phones which is classified; more care should be exercised.	Classified Staff Conf File 2d Div Entry #13
5.		Advance Party Journal	General Bradley, Lt Colonel Holden, Lt Col Epley, Major Webster, and Major Robinson, departed Tokyo for Yokohama to discuss plans for staging the 2d Div (-9th RCT) in Yokohama area. On arrival checking in with the G-3 and C/S of 8th Army Hq at Yokohama. Immediately after the party was conducted by representatives of 8th Army G-3 and 4 on an inspection trip of Camps Atsugi, Zama, and McGill and two minor camps. These camps were checked for troop capacity, types of housing, installation	Adv Party Journal

SECRET

SECRET

HEADQUARTERS SECOND INFANTRY DIVISION
WAR DIARY

250001 Jul 50 - 252400 Jul 50 Continued

Entry No	Time of Action	Authority	Action	Ref
Entry 5 Continued:				
maintenance, service personnel for operation, mess facilities, disposition of service and tactical units. Remainder of advance remained at GHQ, Tokyo for conferences.				
6.	2145	MSG CG 2d Div to CG 6th Army AMBGC 7-460	<p>"1. My msg 7-409 and 7-444. RCT 23 (-37 FA Bn, C B 2 Engr Bn, and Btry B 82 AAA AW Bn), departed aboard USS Darby 242000 Jul. Strength RCT 23 (-): 3261. Cargo ships Linfield and New World departed 242000 and 241500 Jul respectively.</p> <p>2. Current shipping forecast for remainder of Division: USNS Greeley, ETA 1 Aug carrying 500 FA Bn; 82 AAA AW Bn(-); btry C 82 AAA AW Bn; 2 Sig Co (-); 2 Med Bn (-); 702d Ord Maint Co; 2 MP Co (-). USNS Stewart, ETA 2 Aug carrying RCT 38. USNS Collins, ETA 3 Aug carrying RCT 38. USNS Mitchell, ETA 3 Aug carrying Hq Co and Band 2d Inf Div; 72d Tank Bn; 2 Engr Bn (-); 2 Replacement Co; 2d MP Det; 2d CIC Detachment (-); and replacement personnel for units that have departed."</p>	Classified Mvmt File 2d Inf Div Entry #37

FRED J. MEYER,
Captain, Infantry,
Division Historian.

SECRET

SECRET
 HEADQUARTERS SECOND INFANTRY DIVISION
 WAR DIARY

260001 Jul 50 - 262400 Jul 50

Entry No	Time of Action	Authority	Action			Ref
1.		Shipping Status Record 2d Inf Div	Over-all status of shipping as of 1200, 26 July 1950:			Classified Mvmt File 2d Inf Div Entry #42
			Ship	Departed	Units aboard	Strength
			Patrick Morton	2200, 17 Jul 0100, 19 Jul	RCT 9 RCT 9 Adv Det, 2d Inf Div 2d QM (-) 2d Recon Co	1120 55 179 <u>151</u>
			Sultan	0300, 20 Jul	RCT 9	<u>1492</u> <u>1505</u> <u>1973</u>
				RCT 9	4585 <u>17</u> pers on cargo ships 4602	
			Funston	0530, 22 Jul	Hq & Hq Btry Div Arty 37th FA Bn Btry "B" 82 AAA Bn Co "B" 2d Engr Bn Hq & Hq Btry 82 AAA Bn	170 539 136 175 3 <u>1023</u>
			Freeman Darby	2045, 22 Jul 2000, 24 Jul	RCT 23 (-) RCT 23 (-)	1524 <u>1716</u> <u>3240</u>
				RCT 23 (-) 37 FA Bn Btry "B" 82 AAA Co "B" 2d Engr RCT 23	3240 539 136 <u>175</u> 4090	<u>4094</u> 4 pers on cargo ships

SECRET

SECRET

HEADQUARTERS SECOND INFANTRY DIVISION
WAR DIARY

260001 Jul 50 - 262400 Jul 50 Continued

Entry No.	Time of Action	Authority	Action	Ref
-----------	----------------	-----------	--------	-----

Entry 1 Continued:

Status of cargo shipping as of 1200, 26 July 1950:

Ship	Departed	Units having cargo aboard
Towle	0600, 17 Jul	RCT 9
California	0625, 18 Jul	2d Recon Co 2d M Co RCT 9
Mormacson	0430, 22 Jul	RCT 23
Arcadia	0600, 24 Jul	Div Arty. (Co "B" Engrs, Btry "B" 82 AAA AW Bn, 37th FA Bn, Hq & Hq Btry Div Arty)
New World	1200, 24 Jul	RCT 23
Linfield	2000, 24 Jul	RCT 38
Elko	0625, 26 Jul	RCT 23, RCT 38, Div Arty

Tentative plan for shipment of units indicated:

Ship	Unit	T/O Strength	ETD
Greeley	503 FA Bn	666	1 Aug
	82 AAA Bn (-)	316	
	Btry C, 82 AAA Bn	154	
	2d Sig Co (-)	324	
	2d Med Bn (-)	119	
	702 Ord Maint Co	307	
	2d LP Co (-)	70	
	<u>1956</u>		
Stewart	RCT 38* (-)	2502	2 Aug
Collins	RCT 38* (-)	2090	3 Aug
		<u>4592</u>	

SECRET

SECRET

HEADQUARTERS SECOND INFANTRY DIVISION
WAR DIARY

260001 Jul 50 - 262400 Jul 50 Continued

Entry No	Time of Action	Authority	Entry 1 Continued:	Action	Ref
----------	----------------	-----------	--------------------	--------	-----

Ship	Unit	T/O Strength	ETD
Mitchell	72 Tk Bn	684	4 Aug
	2d Engr C Bn (-)	470	
	Hq & Hq Co & Band	477	
	2d Repl Co	41	
	2d CIC (-)	9	
	2d MP Det	15	
	Replacements	1696	
		804	
		2500	

* RCT 38 is expected to be approximately 200 under strength at sailing time. Replacements for RCT 9, 23 and 38 to be brought over on Mitchell.

Tentative plan for shipment of remaining cargo:

Ship	EPA	Cargo of
Joplin	27 Jul	Tk Bn RCT 38
Rutger	29 Jul	72d Tk Bn 2d Engr C Bn (-) 2d Sig Co (-)
Wake Forest	Unk	
Robin Hood	Unk	

2

2155

Msg CG 2d Div to CG 8th Army AMBGC 7-468 "1. Cargo ship Elko departed 260625 Jul carrying cargo of RCT 23 RCT 38 and 2d Div Arty. Msg from AMBGC 7-468 our msgs 7-409 and 7-460. Classified Pers File 2d Inf Div Entry #20

2. Corrected strengths of departed units as follows: RCT 9, 4502, 2d QM Co (-) 182, Adv Det 2d Inf Div 55, 2d Recon Co 154, Hq & Hq Btry 2d Div Arty 170, RCT 23, 4094. Shipping strengths of units not yet departed dependent upon receipt of repl pers."

Fred J. Meyer
FRED J. MEYER,
Captain, Infantry,
Division Historian.

SECRET

SECRET

HEADQUARTERS SECOND INFANTRY DIVISION
WAR DIARY

270001 Jul 50 - 272400 Jul 50

Entry No	Time of Action	Authority	Action	Ref
1.	0103	Msg CG 2d Div to CG 5th Army AMBGC 7-475	Reorganization of Second Infantry Division completed 190001 Jul 50. Reorganization of 2d CIC Det effective 220001 Jul 50. Reorganization ordered by GO 86 Hq 8th Army completed 180001 as previously reported by msg 7-426 (Hq 2d Div).	Msg Destroyed
2.		Advance Party Journal 2d Inf Division	Captain McLaughlin, Captain Cunningham, Major Webster, Major Robinson, and 1st Lt Smith of advance party proceeded from Tokyo, Japan to Yokohama, Japan for continued coordination of 2d Div (-) staging in Yokohama area at Camp McGill, Zama, and Atsugi. Major Webster, Capt Cunningham and Lt Smith coordinated with the various technical and staff sections or agencies of 8th Army. Major Robinson worked with G-1 relative to billeting of troops and occupancy of camps. Major Webster arranged with 8th Army G-4 for debarkation, staging and movement to camps. Preliminary arrangements completed for transport of troops, vehicle marshalling areas, troop guides, traffic control, and reception of units in camps. Technical staffs of 8th Army contacted and briefed on status of division equipment. Arrangements made for supply facilities Class I, II, III, IV & V for the Division. 8th Army G-4 arranging for preparation of camps. (bunks, housekeeping equipment, food, and composite service companies). In the afternoon this coordinating group received instructions to return to Tokyo where they were informed that a change had occurred in Division plans.	Advance Party Journal

3.

1630

IRS AG 2d Div to C/S, G-1, G-2, G-3, G-4.

Enlisted personnel shortages as of 27 July 1950:

Units still to ship		Units departed (Personnel) to be carried in repl co.)	
2d Sig Co	17	2d Recon Co	17
2d MP Co	35	9th Inf (-)	238
702d Ord Co	33	3d Bn 9th Inf	75
2d Med Bn	32	23d Inf	683
2d Engr C Bn	30	Div Arty	43
72d Tank Bn	190	15th FA Bn	3
53th Inf	1609	37th FA Bn	125
30th FA Bn	170		1184
62d AAA AW Bn (SP)	180		
603d FA Bn	56		
	2352		

Classified
Pers File
2d Inf Div
Entry # 21

Estimated Divisional shipping strength:

T/O 1119 Off 17814 EM	Shp Str 1077 Off 15471 EM	Shipped 537 Off 8788 EM
To Be Shipped 540 Off 6683 EM.		

SECRET

SECRET

HEADQUARTERS SECOND INFANTRY DIVISION
WAR DIARY

270001 Jul 50 - 272400 Jul 50 Continued

Entry No	Time of Action	Authorization	Action	Ref
4.	2000	MSG CG 2d Div to CG 8th Army AMBGC 7-416	In reply to message from CG 8th Army, Presidio of San Francisco (07230) the following: "528 MI Svc Plat was reorganized effective 150001 Jul 50. Copies of orders being forwarded your headquarters this date."	Classified Mvmt File 2d Inf Div Entry #44

Fred J. Meyer
FRED J. MEYER
Captain, Infantry,
Division Historian.

SECRET

SECRET

HEADQUARTERS SECOND INFANTRY DIVISION
WAR DIARY

280001 Jul 50 - 282400 Jul 50

Entry No	Time of Action	Authority	Action	Ref
1.		Msg CINCFECOM CX 58879	Instructions received revising movement orders: "Part 1. Desire entire Second Inf Div be routed direct Pusan, Korea. Upon arrival asgd EUSAK. Part 2. FEC repls accompanying 2d Inf Div will be integrated into Div."	Classified Mvmt File 2d Inf Div Entry #47
2.	0549	Msg CINCFECOM CG 2d Inf 58867	"Bradley sends to Kaiser. Whole outfit going direct. Will meet them. Recommend you come by air."	Classified Mvmt File 2d Inf Div Entry #46
3.		Advance Party Journal 2d Div	Plans for 2d Div (-9th RCL) to stage at Yokohama area cancelled. Entire advance party to depart Tokyo, Japan at 290400 July 50 for Pusan, Korea. Entire 2d Div to "go in" at Pusan, Korea.	Adv Party Journal
4.	1400	2d Div Loading Chart	Joplin Victory loaded and to sea with equipment of 38 (-), 72d Tk, 702d Ord.	Classified Mvmt File 2d Inf Div Entry #72

Fred J. Meyer
 FRED J. MEYER,
 Captain, Infantry,
 Division Historian.

SECRET

HEADQUARTERS SECOND INFANTRY DIVISION
WAR DIARY

290001 Jul 50 - 292400 Jul 50

Entry No	Time of Action	Authority	Action	Ref
1.	0400 0745 0915 1215 1600	Advance Party Journal 2d Inf Div	General Bradley's advance party departed (Haneda Airport) Tokyo, Japan for Itazuki Airbase, Kyushu, Japan arriving at 290745. Departed Itazuki, Airbase, for Pusan, Korea. Sighted Korea 291015 but proceod to return to Itazuki because of inclement weather. Departed Itazuki for Pusan arriving at 291320 landing at an airfield 17 miles NW of Pusan from which advance party proceeded to Hq Pusan Base Command arriving at 1600.	Adv Party Journal 2d Inf Div
2.	1135	Adv Party Journal 2d Inf Div Gen Keiser	Major General Laurence E. Keiser, CG of 2d Inf Div departed from Seattle - Tacoma airport by North West Airlines with a party of four (4) officers including: Colonel Carle, Division Surgeon, Lt Colonel Joe A. Mc Eachern, Engineer Officer, 1st Lt Lucian K. Truscott, III, Inf, Aide-de-Camp ADC, 1st Lt Jared W. Morrow, Aide-de-Camp General Keiser.	Adv Party Journal 2d Inf Div Gen Keiser
3.	1830	2d Div Load- ing Chart	Rutger (V) loaded and to sea with equipment of 72d Tank, 2d Engr (-), 2d Sig (-), and elements of LP's.	Classified Mvmt File 2d Inf Div Entry #72
4.	2108	Msg CG 2d Inf Div AMBCC 7-499	*Cargo ship Joplin departed 281400 Jul 50 carrying cargo RCT 38 and 72 Tk Bn. Msg Form AMBCC 7-499 our msg 7-460, current LTD of remaining trp ships as folo: USNS Greeley 2 Aug; USNS Stewart 3 Aug; USNS Collins 4 Aug; USNS Mitchell 4 Aug.	Classified Mvmt File 2d Inf Div Entry #51

Fred J. Meyer
FRED J. MEYER,
Captain, Infantry,
Division Historian.

SECRET

~~SECRET~~
HEADQUARTERS SECOND INFANTRY DIVISION
WAR DIARY

300001 Jul 50 - 302400 Jul 50

Entry No	Time of Action	Authority	Action	Ref
1.		Advance Party 2d Inf Div Journal	Advance party staff section representatives prepared plans with appropriate staff sections of Pusan Base Command for receiving and disposition of 9th RCT. At this time information contained in briefing notes of 27 July presented to CG of Pusan Base Command.	Adv Party Journal 2d Inf Div
2.	2000	MSG CG 2d Inf to CG 6th Army AMBCC 7-508	Report of departure time submitted to CG Sixth Army, Presidio of San Francisco for Cargo Ship Rutger.	Classified Mvmt File 2d Inf Div Entry #53

FRED J. MEYER,
Captain, Infantry,
Division Historian.

~~SECRET~~

SECRET

HEADQUARTERS SECOND INFANTRY DIVISION
WAR DIARY

310001 Jul 50 - 312400 Jul 50

Entry No	Time of Action	Authority	Action	Ref
1.		Advance Party Journal 2d Inf Div	USNS General Patrick, USNS General Sultan, and USNS Pvt John R. Towle arrived Pusan, Korea.	Adv Party Journal 2d Inf Div
2.	1055	Msg CG 2d Inf Div to CG 6th Army Tully 7-512	Major General Laurence Keiser, Commanding General, Second Infantry Division, arrived Tokyo, Japan.	Classified Mvmt File Entry #54
3.	2328	Msg CG 2d Inf Div to CG 6th Army AMBGC 7-517	Shipping forecast for remainder of 2d Infantry Division changed as follows: USNS Mitchell ETD 3 Aug carrying 503 FA Bn; 82d AAA Bn (-); Btry C 82d AAA Bn; 2 Sig Co (-); 2d Med Bn (-); 702d Ord Maint Co; 2d MP Co (-); 72d Tank Bn. USNS Stewart ETD 4 Aug carrying 2627 troops RCT 38. USNS Collins ETD 5 Aug carrying 2165 troops RCT 38. USNS Greeley ETD 5 Aug carrying Hq & Hq Co 2d Inf Div; 2d Inf Div Band; 2d Engr Combat Bn (-); 2d Repl Co; 2d MP Det; 2d CIC Det (-); 528 MI svc Plat; and replacements for departed units of Division. Shipping space avail for approximately 1000 replacements. These replacements will bring Div to within 225 of T/O Str."	Classified Mvmt File 2d Inf Div Entry #55

Fred J Meyer
 FRED J MEYER,
 Captain, Infantry,
 Division Historian.

SECRET

010001 Aug 50 - 012400 Aug 50

HEADQUARTERS SECOND INFANTRY DIVISION
WAR DIARY

Entry No	Time of Action	Authority	Action	Ref
1.		Advance Party Journal 2d Inf Div	USNS General C. G. Morton and California (V) arrived at Pusan, Korea.	Adv Party Journal 2d Inf Div
2.		Advance Party Journal 2d Inf Div	9th RCT (-) departed Pusan Base Command for Kyongsan to revert to Army Reserve.	Adv Party Journal 2d Inf Div
3.	1200	Memo to G-3, 2d Inf Div (Air Party)	Plan for shipment of units remaining at Fort Lewis changed as indicated in the following schedule:	Classified Mvmt File 2d Inf Div Entry #63

Ship	Unit	T/O Str	ETD:
Mitchell	503d FA Bn	666	3 Aug 50
	82d AAA AW Bn (-)	316	
	Btry C, 82d AAA AW Bn	154	
	2d Sig Co (-)	324	
	2d Med Bn (-)	119	
	702d Ord Maint Co	307	
	2d MP Co (-)	70	
	72d Tank Bn	684	
		<u>2640</u>	
Stewart	38th RCT	2627	5 Aug 50
Collins	38th RCT (-Btry C, 82d AAA Bn)	2165 4792	5 Aug 50
Greesley	Hq & Hq Co and Band	477	5 Aug 50
	2d Engr C Bn (-)		
	2d Repl Co	41	
	2d MP Det	15	
	2d CIC Det (-)	9	
	528th MI Svc Plat	22	
	<u>1034</u>		
	Replacements.	1000	
		<u>2034</u>	

SECRET

SECRET

HEADQUARTERS SECOND INFANTRY DIVISION
WAR DIARY

010001 Aug 50 - 012400 Aug 50 Continued

Entry No	Time of Action	Authority	Action	Ref
----------	----------------	-----------	--------	-----

Entry 3 Continued:

1. Above units to ship out at full T/O.
2. Above ships will be over-loaded.
3. 923 replacements for 9th and 23d RCT's will be carried on Greeley. Net total division shortages estimated at only 250.

Status of Cargo Shipping:

Ship	Departed	Units having Cargo Aboard
Joplin	1400, 28 Jul	38 RCT, 72d Tk, 702d Ord
Kutger	1830, 29 Jul	72d Tk, 2d Engr, 2d Sig, 2d MP
Wake Forrest	1600, 1 Aug (ETD)	2d Engr, 702d Ord, Hq & Hq Co, 72d Tk
Robin Hood	1300, 2 Aug (ETD)	72d Tk, 2d Engr, 702d Ord

Note: All division cargo now loaded. Robin Hood last cargo ship out.

4.

1500

2d Div Loading Chart

Wake Forrest (V) loaded and to sea with equipment of 2d Engr, 702d Ord, Hq Co, 72d Tk.

Classified
Mvmt File
2d Inf Div
Entry #72

Fred J. Meyer
FRED J. MEYER,
Captain, Infantry,
Division Historian.

SECRET

SECRET
HEADQUARTERS SECOND INFANTRY DIVISION
WAR DIARY

020001 Aug 50 - 022400 Aug 50

Entry No	Time of Action	Authority	Action	Ref
1.	0244	Msg CG 2d Div to CG 6th Army AMBGC 8-6	<p>1. Recapitulation of shipping:</p> <p>a. Units departed: RCT 9, Adv Det Second Inf Div, 2d QM CO (-), 2d Recon Co, Hq & Hq Btry 2d Div Arty, RCT 23. Air Party 2d Inf Div. Note, composition of RCT and T/O strs as fols: Inf Regt 3739, FA Bn 674, Engr Combat Co 169, AAA AW Btry 154, Clr Plat 51, Amb Plat 23, QM Trk Plat 27, MP Plat 34, QM Bath Unit 4, CIC Det 2, Sig Det 15.</p> <p>b. Estimated combat readiness of departed RCT's as fols: RCT 9, 65%, RCT 23, 75%. Elements of supporting arms and Tech Svc have departed w/above 2 RCTs. Estimated overall combat readiness of organic units as fols: 9th Inf Regt 60%, 23d Inf Regt 70%, 2d Div Arty 70%, Second QM Co 90%, 2d Recon Co 80%, 2d Engr C Bn 96%, 2d Med Bn 70%, 2d MP Co 40%, 2d Sig Co 75%, 2d CIC Det 100%. Estimated combat readiness of remaining units no elements of which have yet departed will be reported at time of departure.</p> <p>2. Major deficiencies:</p> <p>a. Insufficient time to train replacements with parent unit prior to departure. Corrective action: Intensive training aboard ship.</p> <p>b. Shortages of equip: Major shortages in equip revealed by unit showdown shortages reports include water trailers watches and OCUS equip. Existing shortages are approx 70% OCUS items. Corrective Action: Rear echelon processing items directly from respective tech svc depots for shipment to Port marked for unit concerned.</p> <p>3. Amplifying remarks:</p> <p>Influx of new pers makes unit effectiveness virtually impossible to determine. However, caliber of repl is generally high.</p> <p>4. Constructive recommendations:</p> <p>a. List of clothing as outlined in T/A 21 (PLACE) be severely curtailed to only that seasonal clothing absolutely necessary for combat for example delete one pair combat boots, delete jacket shade 33, delete trousers and shirts sun tan and many other items declared non-essential for this move.</p>	Classified Mvmt File 2d Inf Div Entry #65

SECRET

SECRET

HEADQUARTERS SECOND INFANTRY DIVISION
WAR DIARY

020001 AUG 50 - 022400 AUG 50 Continued

Entry No	Time of Action	Authority	Action	Ref
			Entry 1 Continued:	
			b. That OCUS equipment be issued prior to departure from home station.	
2.		Ltr Hq 2d Div AMBGD 370 Aug 1 50	Entrucking schedule for personnel of advance party for USNS Mitchell prepared. Elements to commence loading 1830 2 August 1950.	Classified Mvmt File 2d Inf Div Entry #62
3.		Ltr Hq 2d Div AMBGD 370 Aug 2 50	Entrucking schedule published for USNS Mitchell, advance party embarked this date remainder of elements scheduled for shipment commencing 0700, 3 Aug 50 through 1500, 3 Aug 50.	Classified Mvmt File 2d Inf Div Entry #66
4.	0041	Lsg CG SEPOE to CG 6th Army TCSEP-114023	Port call received for units scheduled to sail on the USNS General William Mitchell, shipments to arrive shipside Navy Commissioning Pier, Tacoma, Washington commencing 1800 2 Aug 50 through 0800 3 Aug 50. Total to embark 164 officers 2459 M.	Classified Mvmt File 2d Inf Div Entry #67
5.	0600 1650	2d Div Loading Chart	Robin Hood (C-3) loaded and to sea with equipment of 72d Tk, 2d Engr (-), 702d Ord (-). USNS General William Mitchell loaded cast off to leave Zone of Interior with the fol: elements of 72d Tk Bn, 505 FA Bn, 32d AAA (-), 2d Sig, 2d Med Bn (-), 702d Ord Main Co (-), and minor elements. Troop strength 116 officers 2425 M total 2590.	Classified Mvmt File 2d Inf Div Entry #72
6.		Adv Party Journal 2d Div	Advance Division CP departed Pusan Base Command for CP of 9th RCT at Kyongsan. Maj Webster, Capt Cunningham, and Capt Tenhant with 1 platoon of QM Co detailed to remain in Pusan to stage movement of the Division on arrival. Adv Party Journal to remain with Major Webster until staging completed.	Adv Party Journal 2d Inf Div

Fred J. Meyer
FRED J. MEYER,
Captain, Infantry,
Division Historian.

SECRET

SECRET
HEADQUARTERS SECOND INFANTRY DIVISION
WAR DIARY

030001 Aug 50 - 032400 Aug 50

Entry No	Time of Action	Authority	Action	Ref
1.	0245	Adv Party Journal 2d Inf Div	Division Forward CP established at Kyongsan, Korea with elements of 9th RCT.	G-2 Miryang Journal Entry #17
2.		Ltr Hq 2d Inf Div	Entrucking schedule for USNS Stewart published and distributed, elements to leave in serials commencing 0900 4 Aug 50 up to and including 1700 4 Aug 50.	Classified Mvmt File 2d Inf Div Entry #69
3.		Ltr Hq 2d Inf Div	Entrucking schedule for USNS Collins published and distributed, elements to leave in serials, 1530, 1900, 2100, and 2300 4 August 1950.	Classified Mvmt File 2d Inf Div Entry #68
4.		Msg CG SAPOE to CG 6th Army TCSEP TMD 67	Port call received for USNS General E. T. Collins requesting personnel arrive shipside Navy Pier J. Tacoma, Washington, commencing 1615 4 Aug 50 through 2000 4 Aug 50. Total to embark 122 officers 2303 EM.	Classified Mvmt File 2d Inf Div Entry #71
5.		Msg CG SAPOE to CG 6th Army TCSEP TMD-67	Port call received for USNS General X. B. Stewart requesting personnel arrive shipside Navy commissioning pier Tacoma, Washington, commencing 0945 4 Aug 50 through 1400 4 Aug 50. Total to embark 128 officers, 2521 enlisted men.	Classified Mvmt File 2d Inf Div Entry #70

Fred G. Meyer
FRED G. MEYER,
Captain, Infantry,
Division Historian.

SECRET

SECRET

HEADQUARTERS SECOND INFANTRY DIVISION
WAR DIARY

040001 Aug 50 - 042400 Aug 50

Entry No	Time of Action	Authority	Action	Ref
1.	2000	Advance Party Journal 2d Inf Div	Mormacsun (V), Funston, and Darby, arrived at Pusan, Korea.	Adv Party Journal 2d Inf Div
2.		Periodic Oph Report # 1. 2d Div	Advance CP, 2d Infantry Division opened vicinity of KYONGSAN. Areas of future operations reconnoitered. Orientation by KMAC officers. Plans effected for assembly of Divisional units in vicinity of SANNANGJIN.	G-2 Miryang Journal Entry 43

Fred J. Meyer
FRED J. MEYER,
Captain, Infantry,
Division Historian.

SECRET

SECRET

HEADQUARTERS SECOND INFANTRY DIVISION
WAR DIARY

050001 Aug 50 - 052400 Aug 50

Entry No	Time of Action	Authority	Action	Ref
1.	0800 1200 1500	2d Inf Div Loading Chart	Troopship Greeley (C-4) loaded and to sea with following units: Div Hq, 2d Engr (-), 2d Engr (-), 2d Repl Co's A, B, C, D, Med Det, 528 MI Svc Plat, CIC Det, Band, 2d MP. Troop strength 139 officers 2004 enlisted men total 2143. Troopship Stewart (C-4) loaded and to sea with following units: 33th RCT (38th RCT 1st and 3rd Bn, 38th FA, Co "C" 2d Engr). Troop strength 129 officers 2523 enlisted men total 2652. Troopship Collins (C-4) loaded and to sea with following units: 33th RCT 2d Bn, 38th FA. Troop strength 111 officers 2030 enlisted men total 2141.	Classified Mvmt File 2d Inf Div Entry #72
2.		Advance Party Journal 2d Inf Div	USNS General Freeman arrived Pusan, Korea.	Adv Party Journal 2d Inf Div.
3.		Periodic Opn Report 2d Div #4	Operational Directive, Headquarters EUSAK, dated 5 August 1950 pertaining to counter-attack plans has been received this headquarters, is being studied.	G-2 Miryang Journal Entry #78
4.	2215	Periodic Opn Report 2d Div #5	C/S EUSAK called CG 2d Inf Div directing that one (1) Bn from 9th RCT with the necessary attachments to be alerted for possible movement to and employment in 2/A of the 24th Div. 1st Bn, 9th RCT designated as alerted Bn.	G-2 Miryang Journal Entry #79
5.		EUSAK Adm O #25 "A" 3 Aug 50.	EUSAK Administrative Order No 25 "A", dated 3 Aug 50, received authorizing commanders of Major subordinate commands to make direct appointments as 2d Lieutenants in the Army of the United States within limit of T/O and T/D vacancies of Warrant Officers and enlisted men in Korea. Following service numbers allocated to 2d Inf Div: 02202045 to 02212059 inclusive. Additional service numbers to be furnished upon request. Promotion without regard to local vacancies authorized for enlisted personnel in lower three grades. Quota granted for promotion of personnel to top four grades: E-7 70; E-6 105; E-5 365; E-4 300.	G-2 Miryang Journal Entry #83

Fred J. Meyer
FRED J. MEYER,
Captain, Infantry,
Division Historian.

SECRET

HEADQUARTERS SECOND INFANTRY DIVISION
WAR DIARY

060001 Aug 50 - 062400 Aug 50

Entry No	Time of Action	Authority	Action	Ref
1.		EUSAK Opn Directive 6 Aug 50	Operational Directive received from Headquarters EUSAK dated 6 August 1950 directing 2d Infantry Division (-) to continue to assemble vicinity of SAMNANGJIN. One (1) RCT to remain vicinity KYONGSAN as Army reserve.	G-2 Miryang Journal Entry #93
2.	Period Opn Report 2d Div #7	Personnel of 23d Infantry	closed Wongdong area at 1100. Vehicles of RCT arriving on Cargo Ship Mormacsun (approx 35% of RCT vehicles) closing in Wongdong area at 1800. Balance of vehicles still on cargo ship Arcadia and New World Victory with ETA for both ships of 7 August 1950. 2d Reconnaissance Company departed Pusan at 1100 for SAMNANGJIN. Plan to move 1st Bn, 9th RCT to Z/A 24th Division placed into effect 0900 6 Aug. 1st Bn 9th RCT departed KYONGSAN area 1132K by organic transportation fr 9th RCT for CHANGNYONG area. Lead elements arrived CHANGNYONG area 1730.	

Fred A. Meyer
FRED A. MEYER,
Captain, Infantry,
Division Historian.

SECRET
HEADQUARTERS SECOND INFANTRY DIVISION
WAR DIARY

070001 Aug 50 - 072400 Aug 50

Entry No	Time of Action	Authority	Action	Ref
1.		Ltr CIC 2d Inf Div "Info Report #1"	Investigations during 1st week of August indicate that infiltration of communists through refugees is minimal. Local check points operating satisfactorily.	G-2 Miryang Journal Entry #117
2.		Period Opn Report 2d Inf Div #10	5th Prov Korean Police Company attached to the 2d Infantry Division closed KYONGSAN area 071800K August 1950.	G-2 Miryang Journal Entry #141
3.		Period Opn Report 2d Inf Div #11	Tactical Air Control Party (TACP) attached to 9th RCT closed KYONGSAN area as of 061400K August 1950. At 2215 C/S EUSAK directed CG 2d Inf Div to take necessary action to move immediately the 9th Infantry Regiment (less one battalion) to CHANGNYONG. Unit to pass to operational control of CG 24th Division upon arrival. 2d Bn 9th Inf designated as the Bn to move to Z/A 24th Div. 3d Bn, 9th Inf designated to remain KYONGSAN area.	G-2 Miryang Journal Entry #142



FRED J. MEYER,
Captain, Infantry,
Division Historian.

SECRET

~~SECRET~~
HEADQUARTERS SECOND INFANTRY DIVISION
WAR DIARY

080001 Aug 50 - 082400 Aug 50

Entry No	Time of Action	Authority	Action	Ref
1.		Advance Party Journal 2d Div	Cargo ship New World (V) arrived docked at Pier 2, Pusan, Korea.	Advance Party Journal 2d Inf Div.
2.			No other significant events. Routine administrative and functional activities performed.	

FRED J. MEYER,
Captain, Infantry,
Division Historian.

~~SECRET~~

SECRET

HEADQUARTERS SECOND INFANTRY DIVISION
WAR DIARY

090001 Aug 50 - 092400 Aug 50

Entry No	Time of Action	Authority	Action	Ref
1.		Periodic Opn Report 2d Div #16	Hq & Sv Btry 15th FA departed KYONGSAN area 1050 for 9th RCT Hq at CHANGNYONG. Cargo ship, New World, started unloading cargo of RCT 23 at 091040 Aug 50. At 1700, unloading was reported 20% completed. Estimated time of completion of the unloading is 101200 Aug 50. Est that all vehicles and impedimenta unloaded from the New World will close WONGDONG area 101800K Aug 50.	G-2 Miryang Journal Entry #179



FRIED J. MEYER,
Captain, Infantry,
Division Historian.

SECRET

HEADQUARTERS SECOND INFANTRY DIVISION
WAR DIARY

100001 Aug 50 - 102400 Aug 50

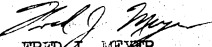
Entry No.	Time of Action	Authority	Action	Ref
1.	Periodic Opn Report 2d Div #19	23d RCT	ordered to initiate immediately move of one (1) Bn Combat Team from the WONGDONG area to the KYONGSAN area. Remainder of RCT to follow as soon as possible to KYONGSAN area.	G-2 Miryang Journal Entry #191
		Task Force Bradley (3d Bn, 9th RCT, Tank Co, 9th RCT; Co A, 2d Engr C Bn, Btry A, 82d AAA AW Bn (SP) and Hq 9th RCT Rear)	ordered to proceed at once to the YONGDONG-NI area to secure the YONIL AIRBASE.	
2.	Periodic Opn Report 2d Div #20	Task Force Bradley	departed KYONGSAN area 101827K Aug 50 for the YONGDONG-NI area. At 2230K Aug 50 Task Force Bradley lead elements reported at KYUNJU.	G-2 Miryang Journal Entry #195

FRED J. MEYER,
Captain, Infantry,
Division Historian.

SECRET

SECRET

HEADQUARTERS SECOND INFANTRY DIVISION
WAR DIARY

110001 Aug 50 - 112400 Aug 50 -

Entry No	Time of Action	Authority	Action	Ref
1.		Periodic Opn Report 2d Div #21	Task Force Bradley lead elements arrived YONGDONG-NI. Elements of 23rd RCT KYONGSAN area.	G-2 Miryang Journal Entry #196
2.		Periodic Opn Report 2d Div #22	Plans initiated to utilize the 1st Bn, 23d RCT to move to POHANG DONG to reinforce Task Force Bradley if the need should arise. (Plans did not materialize as Task Force Elements proved adequate.) 2d Bn and 3d Bn 23d RCT RCT directed to make reconnaissance to NOHANG-DONG and 1st Cav Div Z/A for possible employment.	G-2 Miryang Journal Entry #212
3.		Operations Directive EUSAK, 11 Aug 1950.	Confirmation of oral and fragmentary orders contained EUSAK Operational Directive 11 August 1950, governing disposition and utilization of Division elements, received.	G-2 Miryang Journal Entry #230

Fred J. Meyer
FRED J. MEYER,
Captain, Infantry,
Division Historian.

SECRET

SECRET

HEADQUARTERS SECOND INFANTRY DIVISION
WAR DIARY

120001 Aug 50 - 132400 Aug 50

Entry No	Time of Action	Authority	Action	Ref
1.		Periodic Opn Report 2d Div #25	23d RCT minus 3d BCT directed to move to Miryang area to report to CG, 24th Division for further orders. Initial elements departed KYONGSAN area 1430 hours.	G-2 Miryang Journal Entry #235
2.		Advance Party Journal 2d Div	Cargo ships Joplin (V) and Elko (V) arrived Pusan, Korea. Rutgers (V) expected tomorrow late.	Advance Party Journal 2d Div

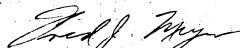

FRED J. MEYER,
Captain, Infantry,
Division Historian.

SECRET

HEADQUARTERS SECOND INFANTRY DIVISION
WAR DIARY

130001 - 132400 Aug 50

Entry No	Time of Action	Authority	Action	Ref
1.		Advance Party Journal 2d Div	Unloading of Elko (V) and Joplin (V) nearing completion. Cargo ship Rutgers (V) arrived Pusan, Korea.	Adv Party Journal 2d Div.

FRED N. MEYER,
Captain, Infantry,
Division Historian.

SECRET

SECRET

HEADQUARTERS SECOND INFANTRY DIVISION
WAR DIARY

140001 AUG 50 - 142400 AUG 50

Entry No	Time of Action	Authority	Action	Ref
1.	Periodic Opn Report 2d Div #51	Elements of 23d RCT in Miryang area (less 1st Bn, RCT) ordered to proceed to KYONGSAN area. First elements enroute from MIRYANG area arrived KYONGSAN area 1800 14 August. Movement to be completed by morning of 15th.		G-2 Miryang Journal Entry #255

Fred J. Meyer
FRED J. MEYER,
Captain, Infantry,
Division Historian.

SECRET

SECRET

HEADQUARTERS SECOND INFANTRY DIVISION
WAR DIARY

150001 AUG 50 - 152400 AUG 50

Entry No	Time of Action	Authority	Action	Ref
1.		Adv Party Journal 2d Div	Cargo ship Wake Forest (V) arrived and unloading Pusan, Korea.	Adv Party Journal 2d Div
2.	Periodic Opn Report 2d Div #34		1200 hours 15 August 1950 the 37th FA Bn (-) was directed to move to the 1st Cavalry Area of Authority for employment with the 1st Cav Div Artillery. At 1345 hours 15 Aug 50 order cancelled for higher priority mission. At 1315 hours 15 Aug 50 Hqs EUSAK directed one (1) Bn from 23d RCT and one (1) battery from the 37th FA Bn move from KYONGSAN area to the KYONGJU area to take up defensive positions North of town. At 1515 hours 15 Aug 50 units designated departed for KYONGJU area.	G-2 Miryang Journal Entry #263
3.	Opn Dir EUSAK, 15 Aug 50.	Opn Dir Hq EUSAK, 15 Aug 50 to the CG 24th Inf Div provided for the following:	<p>"a. Attack as early as practicable 17 August 1950, at time selected by Commanding General 24th Infantry Division. Report time of attack prior to 161500 K August 50.</p> <p>b. The 9th RCT (-) will remain in position until passed through by the 1st Provisional Marine Brigade when 9th RCT reverts to Army reserve and assembles in the vicinity of MIRYANG.</p> <p>c. A and B batteries, 15th FA Bn, will continue to support the attack from initial attack positions until attack has passed beyond their range at which time they will revert to the control of the 9th RCT (-) and will assemble in the vicinity of MIRYANG.</p> <p>d. 1st Platoon 23d Tank Company is attached to 1st Provisional Marine Brigade."</p>	G-2 Miryang Journal #265

Fred J. Meyer
 FRED J. MEYER,
 Captain, Infantry,
 Division Historian.

SECRET

HEADQUARTERS SECOND INFANTRY DIVISION
WAR DIARY

160001 Aug 50 - 162400 Aug 50

Entry No	Time of Action	Authority	Action	Ref
1.		Adv Party Journal 2d Inf Div	Cargo ship Robin Hood arrived and unloading Pusan, Korea.	Adv Party Journal 2d Inf Div
2.		Adv Party Journal 2d Inf Div	advance elements of Division Forward departed Kyongsan for new CP location 4 miles NW of Miryang, Korea near Tanyang, River.	Adv Party Journal 2d Inf Div
3.		Periodic Opn Report 2d Div #37	1455 August 1950, 23d RCT (-) ordered to move to KYONGJU area immediately. Elements unit departed KYONGSAN area by 1615 hours. 2d Bn 23d RCT directed to move to KYONGJU area upon closing of 27th RCT at KYONGSAN.	G-2 Miryang Journal Entry #280

Fred J. Meyer
FRED J. MEYER,
Captain, Infantry,
Division Historian.

SECRET

170001 Aug 50 - 172400 Aug 50

HEADQUARTERS SECOND INFANTRY DIVISION
WAR DIARY

Entry No	Time of Action	Authority	Action	Ref
1.		2d CIC Report WD AGO 58E	Korean National Police in TAEGU reported approximately eighty (80) guerrillas operating in area west-by-north of CH'ONGDO in vicinity of YUGA Temple. Two (2) platoons of Korean National Police dispatched to control situation.	G-2 Miryang Journal Entry #299
2.			No other significant events. Routine administration and functional activities.	

Fred J. Meyer
FRED J. MEYER,
Captain, Infantry,
Division Historian.

SECRET
HEADQUARTERS SECOND INFANTRY DIVISION
WAR DIARY

180001 Aug 50 - 182400 Aug 50

Entry No	Time of Action	Authority	Action	Ref
1.			No significant entries. Routine administration and functional operations.	

Fred J. Meyer
FRED J. MEYER,
Captain, Infantry,
Division Historian.

SECRET

SECRET

HEADQUARTERS SECOND INFANTRY DIVISION
WAR DIARY

190001 Aug 50 - 192400 Aug 50

Entry No	Time of Action	Authority	Action	Ref
1.		Adv Party Journal 2d Inf Div	Troopship Stewart arrived Pusan, Korea. Troopship General Collins (C-4) arrived Pusan, Korea, and with exception of advance details personnel to remain aboard ship for night. Facilities not immediately available to accommodate troop complement. Troopship General Greeley arrived Pusan, Korea, and with exception of advance details all personnel to remain aboard ship and debark on 20 August 1950.	Adv Party Journal 2d Inf Div
2.		2d CIC Report	Guerrilla activity in vicinity of KAM-NI. Guerrillas interrogated villagers and took supplies. All wore NK military uniforms. Incident occurred approximately 2300 hours to 0400 19 August 1950.	G-2 Miryang Journal Entry #321
3.		2d CIC Report	Twenty thousand (20,000) refugees are reported to be congregated mainly in three villages, KUGYU, WORAM, and PORILNYONG. These people have migrated from the west around the region bounded on the west by the NAKTONG RIVER.	G-2 Miryang Journal Entry #320
4.		Journal Entry G-2 Section 2d Inf Div	Msg received from IVORY-2 (2d Div Arty) that Guerrillas operating three (3) miles across NAKTONG RIVER from Division Artillery Headquarters.	G-2 Miryang Journal Entry #322
5.		Journal Entry G-2 Section 2d Inf Div	Call received from 2d CIC to inform G-2 that a patrol of police were being sent to look for a band of 50 guerrillas indicated prior msg. Notification will be given of results.	G-2 Miryang Journal Entry #323
6.		Ltr of Instr CG EUSAK	Letter of Instruction received from CG, EUSAK, directing pursuit of vigorous patrol activity in areas of responsibility.	G-2 Miryang Journal Entry #348

Fred J. Meyer
FRED J. MEYER,
Captain, Infantry,
Division Historian.

SECRET

HEADQUARTERS SECOND INFANTRY DIVISION
WAR DIARY

200001 AUG 50 - 202400 AUG 50

Entry No	Time of Action	Authority	Action	Ref
1.		EUSAK PIR 38, Pd fr 132400 192400	In area of 24th Infantry Z/A the area to be taken over by 2d Infantry Division the enemy rendered only slight resistance to advancing friendly forces as the enemy sought to disengage, and withdraw to the west of the NAKTONG RIVER leaving behind considerable amount of heavy equipment and artillery. Mopping up continued east of the river. No change in enemy situation in Northern Bridgehead being contained by the 23d Inf Regt. In area near POHANG-DONG where Task Force Bradley operating friendly forces continued advance during entire period meeting only slight resistance. At end of period friendly forces had advanced approximately 2,500 yds north of town of POEANG.	G-2 Miryang Journal Entry #346
2.		Opn Dir EUSAK	Opn Dir received from EUSAK governing utilization of 2d Infantry Division: "Upon closing of 38th RCT in the vicinity of MIRYANG and at such time as the CG, 2d Inf Div designates it as having attained a state of readiness for employment, relief of the 24th Inf Div by the 2d Inf Div will be initiated. Units available to effect relief: Headquarters and Special Troops Division Artillery (-) 9th RCT less TF Bradley 38th RCT 1st Bn 23d RCT, reinforced. Task Force Bradley to continue current operational mission. 23d RCT (-) continue current operational mission. 14th Engineer (C) Bn to assemble vicinity CH'ONGDO and be prepared to support 2d Inf Div. Transfer of command to CG 2d Inf Div to be on order of CG EUSAK. Elements of 2d Div currently attached to 24th Inf Div remain attached until command passes to CG 2d Div.	G-2 Miryang Journal Entry #333
3.		EUSAK SITREP 202200 K Aug 50	No significant enemy activity reported prospective Z/A 2d Inf Div as of 2200 hours.	G-2 Miryang Journal Entry #351

Fred G. Meyer
FRED G. MEYER,
Captain, Infantry,
Division Historian.

SECRET
HEADQUARTERS SECOND INFANTRY DIVISION
WAR DIARY

210001 Aug 50 - 212400 Aug 50

Entry No	Time of Action	Authority	Action	Ref
1.		LUSAK SITREP 210400K	As of 210400K Aug 50 enemy activity in proposed Z/A 2d Inf Div confined to patrols.	G-2 Miryang Journal Entry #352
2.	ADM O 1 Hq 2d Inf Div		<p>Railhead Opns for I, II, III, and IV supplies to be operated by 24th Div until 2d Div assumes responsibility upon mutual agreement of CG's concerned.</p> <p>Div Class I Railhead SP to be located at MIRYANG.</p> <p>Div Class II & IV: CM - Div C1 1 Railhead, SP, MIRYANG. Ord and Cml 2 mi S of YUCHON. Sig, Eng, & Med MIRYANG.</p> <p>Div Class III: Railhead Miryang.</p> <p>Div Class V: Army SP YUCHON. DAO YUCHON</p> <p>Vehicle Collecting Pt: 2 mi S of YUCHON.</p> <p>Salvage: Collection Pt MIRYANG - Ord Coll Pt 2 mi S of YUCHON.</p> <p>Evacuation and Hospitalization: Three (3) clearing stations established. MIRYANG, PUGONG-NI, and CHANGNYONG. Hospitalization to be at 8076 ASH MIRYANG.</p> <p>Traffic control in Div Zone by 24th Div for 22 Aug and after until such time as 2d Div assumes responsibility thence by mutual agreement of FM's 2d and 24th Div.</p> <p>Instructions issued governing personnel functions:</p> <ol style="list-style-type: none"> a. Strength, records, and reports. b. Replacements. c. Discipline, law, and order: Straggler Points CHANGNYONG, YONGSAN, MIRYANG. d. Prisoner of war enclosures: CHANGNYONG and MIRYANG. e. Burials and graves registration: Div cemetery vic of MIRYANG. f. Awards and decorations. g. Mail. h. Civil affairs. <p>Rear echelon of Division to be MIRYANG after 23 August, 1950.</p>	

 FRED J. MEYER,
 Captain, Infantry,
 Division Historian.

SECRET

SECRET

HEADQUARTERS SECOND INFANTRY DIVISION
WAR DIARY

220001 Aug 50 - 222400 Aug 50

Entry No	Time of Action	Authority	Action	Ref
1.		Journal Entry G-2 Section 2d Inf Div	Opn C #1 Hq 2d Inf Div dtd 212000 initiates relief of the 24th Inf Div by the 2d Inf Div on 22 Aug 50 as directed by Opn Dir EUSAK.	G-2 Miryang Journal Entry #370
2.		EUSAK SITREP	As of 220400 K Aug 50 no enemy activity reported in proposed Z/A of 2d Inf Div.	G-2 Miryang Journal Entry #365
3.	2200	Journal Entry G-2 Section 2d Inf Div	38th RCT took command 21st RCT sector.	G-2 Journal Entry # 72
4.	1200	Journal Entry G-2 Section 2d Inf Div	9th RCT commenced relief of 19th and 54th RCT's.	G-2 Journal Entry # 72



FRED J. MEIER,
Captain, Infantry,
Division Historian.

SECRET

HEADQUARTERS SECOND INFANTRY DIVISION
WAR DIARY

230001 Aug 50 - 232400 Aug 50

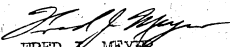
Entry No	Time of Action	Authority	Action	Ref
1.	2055	Journal Entry G-2 Section 2d Inf Div	Instructions given reference engineers reporting for detailed terrain study and reconnaissance of area around HILL 409. Reconnaissance party to commence 240300K.	G-2 Journal 2d Inf Div Entry #26

FRED Z. MEYER,
Captain, Infantry,
Division Historian.

SECRET

HEADQUARTERS SECOND INFANTRY DIVISION
WAR DIARY

240001 Aug 50 - 242400 Aug 50

Entry No	Time of Action	Authority	Action	Ref
1.	0950	Journal Entry G-2 Section, 2d Inf Div.	G-2 3th Army received two requests from 2d Inf Div for photo coverage of HILL 409.	G-2 Journal 2d Inf Div Entry # 46
2.	1515	Journal Entry G-2 Section, 2d Inf Div.	Message received from 38th Inf reference number of refugees within battle lines. Request submitted to move them to rear. 38th Inf reminded of policy that no more will be permitted to cross lines. Orders given to shoot to kill if nec.	G-2 Journal 2d Inf Div Entry #74
3.	1500	Journal Entry G-2 Section, 2d Inf Div.	Instructions given to IMPEL-2 to facilitate movement of tanks when necessary. knock out dikes and drain rice paddies along likely routes of tank approach.	G-2 Journal 2d Inf Div Entry #76
4.	1800	Journal Entry G-2 Section, 2d Inf Div.	CG 2d Inf Div assumed command of 24th Division Sector.	G-2 Journal 2d Inf Div Entry #86
5.	1815	Journal Entry G-2 Section, 2d Inf Div.	IPW team with Task Force 9th Infantry Regiment, 3d Bn, placed under operational control of G-2 2d Division.	G-2 Journal 2d Inf Div Entry #84
6.	2000	Journal Entry G-2 Section, 2d Inf Div.	38th Inf Regt-6 requested surrender leaflets be dropped on HILL 409. Eighth Army requested to furnish leaflets.	G-2 Journal 2d Inf Div Entry #100
7.		Journal Entry G-2 Section, 2d Inf Div.	Refugees: Army G-1 states that 65,000 refugees in north part of zone are nearly all dependents of ROK troops and have been told to stay put in that area by SK government. Colonel Tanner requested to ask Army for an official of the SK government empowered to make decisions to come to 2d Division Forward CP on 25th to find a solution for problem.	G-2 Journal 2d Inf Div Entry #24

Fred J. Meyer
FRED J. MEYER,
Captain, Infantry,
Division Historian.

SECRET

SECRET

HEADQUARTERS SECOND INFANTRY DIVISION
WAR DIARY

250001 Aug 50 - 252400 Aug 50

Entry No	Time of Action	Authority	Action	Ref																		
1.	0830	Journal Entry G-2 Section, 2d Infantry Div.	Request for propaganda leaflets to be complied with by 8th Army. Lt Col Harris to have leaflets (safe conduct passes and UN Forces strength propaganda) at TAEGU AP for pickup. 105 Smoke Shells with leaflets to be delivered within 2-3 days.	Journal G-2 2d Inf Div Entry #112																		
2.	1145	Journal Entry G-2 Section, 2d Inf Div.	Refugees: Impel-2 informed that refugees to be moving through area in large numbers and not to fire on them.	G-2 Journal 2d Inf Div Entry #121																		
3.	1550	Journal Entry G-2 Section, 2d Inf Div.	Message received from Scotch 802 Forward: Distribution of 15000 copies "Safe Conduct Pass and 22500 copies propaganda leaflets (surrender) starting at 1050K over HILL 409 and hills west to the NAKTONG RIVER. Distributed evenly and along NAKTONG RIVER in easterly direction to point of north knoll of HILL 409.	G-2 Journal 2d Inf Div Entry #130																		
4.	1436	Journal Entry G-2 Section, 2d Inf Div.	SOP prepared for defense of the Div Command Post.	G-2 Journal 2d Inf Div Entry #134																		
5.	Periodic Opn Report 2d Div #B4	Composition of friendly forces at 1800 24 Aug 50 (date CG took over responsibility for NAKTONG RIVER line from confluence of NAM and NAKTONG RIVERS north to HYONGPUNG):	<table border="0"> <tr> <td>2d Inf Div Hq</td> <td>2d Div Art Hq</td> <td>9th RCT (-)</td> </tr> <tr> <td>33th RCT (-)</td> <td>1st Bn, 23d Inf (reinf)</td> <td>19th RCT (atcd as 2d Div Res)</td> </tr> <tr> <td>15th FA Bn (D/S 9th RCT)</td> <td>33th FA Bn (D/S 33th RCT)</td> <td>503d FA Bn (D/S 2d Div)</td> </tr> <tr> <td>11th FA Bn (Atcd to G/S 2d Div)</td> <td>2d Engr C Bn</td> <td>702d Ord Co</td> </tr> <tr> <td>2d Sig Co</td> <td>2d LP Co</td> <td>2d Rcn Co</td> </tr> <tr> <td>72d Tk Bn</td> <td>2d Med Bn</td> <td></td> </tr> </table>	2d Inf Div Hq	2d Div Art Hq	9th RCT (-)	33th RCT (-)	1st Bn, 23d Inf (reinf)	19th RCT (atcd as 2d Div Res)	15th FA Bn (D/S 9th RCT)	33th FA Bn (D/S 33th RCT)	503d FA Bn (D/S 2d Div)	11th FA Bn (Atcd to G/S 2d Div)	2d Engr C Bn	702d Ord Co	2d Sig Co	2d LP Co	2d Rcn Co	72d Tk Bn	2d Med Bn		G-2 Journal 2d Inf Div Entry #186
2d Inf Div Hq	2d Div Art Hq	9th RCT (-)																				
33th RCT (-)	1st Bn, 23d Inf (reinf)	19th RCT (atcd as 2d Div Res)																				
15th FA Bn (D/S 9th RCT)	33th FA Bn (D/S 33th RCT)	503d FA Bn (D/S 2d Div)																				
11th FA Bn (Atcd to G/S 2d Div)	2d Engr C Bn	702d Ord Co																				
2d Sig Co	2d LP Co	2d Rcn Co																				
72d Tk Bn	2d Med Bn																					
		9th Inf (-) and 33th Inf ordered to effect aggressive patrol action on west side of NAKTONG RIVER in front of respective Z/A.																				
		2d Recor ordered to make reconnaissance of area north of CHANGNYONG to vicinity boundary between 1st Cav Div and 2d Inf Div.																				
		Company C, 33th Inf reinforced directed to move to HYONGPUNG.																				

SECRET

SECRET
HEADQUARTERS SECOND INFANTRY DIVISION
WAR DIARY

250001 Aug 50 - 252400 Aug 50 Continued

Entry No	Time of Action	Authority	Action	Ref
			Entry 5 Continued:	
			Physical contact made with elements of 25th Div and 1st Cav. Telecon established.	
6.		PIR #1 Hq 2d Inf Div	Enemy disposition: Unidentified elements of the 10th rifle div vic of SONJONG-DONG, elements of 10th Inf Div vic of TOKSUNG-DONG. 29th Rifle Regiment vic KAEP'0-DONG. 27th Rifle Regiment vic of ALLIM-DONG. Elements of 10th Rifle Div vic of MAECHON-DONG. Elements of 1st Bn 29th Rifle Regt vic of CHOJI-DONG. Unidentified armor and rifle units and armored elements paralleling the NAKTONG RIVER from confluence of HWANG RIVER south to ferry crossing or ford. Air OP reports possible build-up in vicinity 5-6 miles W of NAKTONG RIVER opposite broad front from confluence of NAM GANG in south to HWANG GANG in north. Elements of 4th Rifle Div vicinity of PYONGCHON*NI. 18th, 17th, and 16th Rifle Regts of 4th Rifle Division deployed along NAKTONG to NW and S of YUJI-RI, TONGDONG-NI - TAIBU-RI - SINCHON-NI triangle, and PAGYA-RI respectively.	G-2 Journal 2d Div Entry #159A
			Enemy Operations During Period: Probing all along the division zone to feel out dispositions. Patrolling and infiltration. Soldiers intermingling with refugees carrying arms.	
			Administrative Units and Installations: Air report of concentration of 150 barrels of fuel and supplies in area oppsite 3d Bn of 38th Inf across NAKTONG RIVER in vic of PYONGCHON*NI where elements of the NK 18th Regt of the 4th Div have been reported.	
			Antitank Units: Four (4) AT guns reported by Air OP in the town of NANDONG, held by 18th Regt of 4th Inf Div.	
			Armor: Evidence that track vehicles operating in the vicinity of HILL 409. Air observer reported that in the village of CHANGDONG, which is SW of HILL 409 four (4) and possible five (5) tracked vehicles had been operating within a large red clay compound since last rain at 2200 hours of 24 Aug 50.	
			Infantry: Enemy infantry reported in area of 17th Regt of 4th Inf Div w/str of approx 200 in grp. Troops moving into village in zone of 18th Regt of 4th Inf Div. A grp of 20-30 trps moved into village of OKCHONG at approx 1225 hours.	
			Estimated enemy losses: PW's: 14 KIA & MIA: 56	

SECRET

HEADQUARTERS SECOND INFANTRY DIVISION
WAR DIARY

280001 Aug 50 - 282400 Aug 50 Continued

Entry No	Time of Action	Authority	Action	Ref
-------------	-------------------	-----------	--------	-----

Entry 6 Continued:

Guerrilla Activity: Enemy guerrilla action in vicinity of CHANGNYONG.

Enemy Capabilities: Continue to reinforce units east of the NAKTONG RIVER with intent of attacking right flank of Div zone. In conjunction with this operation to infiltrate behind front lines cutting lines of communication and attacking supply and artillery positions. Reinforce units of the 4th Div and attack the Div left flank. In effect this means the enemy is capable of reinforcing his units by lateral movement from other areas with continued probing of our lines to be expected along with infiltration through lines and harrasing rear areas.

Refugees: Approximately five thousand (5,000) Korean refugees have been evacuated from CHANGNYONG and YONGSAN. Approximately 2,600 have arrived in the screening center at Susan-NI to date. Screening is being conducted at SUSAN-NI by Korean CIC personnel under the supervision of the MIRYANG team of the 2d CIC Detachment. Evacuation of approx 50,000 Korean refugees from UNBONG-NI was begun. CIC is coordinating arrangements with civilian authorities in CHANGDO to establish centers for screening and to provide for feeding. Initial evacuees due to arrive HUKSOKTONG, feeding station by 252100. Initial arrivals expected in-areas east of CHONGDO during period 271200 to 272000.

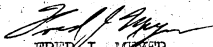
FRED J. LETTER,
Captain, Infantry,
Division Historian.

SECRET

SECRET
HEADQUARTERS SECOND INFANTRY DIVISION
WAR DIARY

260001 Aug 50 - 262400 Aug 50

Entry No	Time of Action	Authority	Action	Ref
1.		FOR #67 Hq 2d Inf Div	Activity limited to patrolling. 38th Inf Regt ordered to reconnoiter enemy pocket in the HILL 409 Sector. Eighth Army Operational Directive extends division boundary 10,000 yards to the north effective on 28 August 1950.	G-2 Journal File 2d Div Entry #242
2.		FTR #2 Hq 2d Inf Div	<p>Enemy Disposition: Unidentified elements of a Regt of the 10th Inf Div located in the vicinity of SONJONG-DONG. Div Hq 10th Inf Div vic of OKKYE-DONG. 29th Regt 10th Inf Div vic KARP'O-DONG. U/I inf KUJU-MYON vic of HILL 409, S of HUMPUNG. 27TH Regt 10th Inf Div vic of PYONGJI-DONG SE of ALLIM-DONG. 18th Regt 4th Inf Div vic of SINBAN-NI. 18th Regt 4th Inf Div vic of SINCHON-NI. 17th Regt 4th Inf Div vic of ferry crossing SE of CHUGGYO-RI on NAM RIVER. 18th Regt 6th Div vic of POKKONG-NI. Regt of SP number 104 (-) W of UIRYONG. Buildup of inf, engr, and SP on road net between bridge crossing NAKTONG to SINBAN-NI. Tracks indicating use of sand bag bridge by veh N of HILL 409 and E of HYON'UNG. Armored veh w/25 trps vic of YULCHI-RI at approx 1730 hours.</p> <p>Enemy Opn During Period: Enemy making preparations for crossing the NAKTONG RIVER opposite the 38th and 9th Inf Regts. Small groups moving along the W bank of the river with small engineer parties constructing rafts. Artillery moderately active in 38th Inf zone. Approx one (1) Bn enemy troops digging in W of river opposite 38th Inf.</p> <p>Artillery: Four (4) howitzers and one (1) SP gun located in the zone of the enemy 18th Regt, 4th Div. Patrols indicate that an en artillery unit preparing positions opposite zone of 38th Inf.</p> <p>Administrative Units: Enemy ammo dump and carts located and destroyed in area of 25th Regt, 10th Div at 252024.</p> <p>Engineer Activities: Enemy sandbagged bridge observed across NAKTONG in area of enemy 29th Regt 10th Div by Div Air OP. enemy using cattle by driving them ahead of their large scale attacks.</p> <p>Infantry: Enemy troops fr the 25th Regt, 10th Div crossed river unknown pt opposite 2d Bn, 38th Inf; driven back by mortar and artillery fire. Increase in troops (str unknown) area occupied by 18th Regt, 4th Div.</p> <p>Enemy losses: PW's: None. Killed: 10 wounded: 20</p> <p>Enemy capabilities: Movement of enemy troops and vehicles eastward toward NAKTONG RIVER opposite CHANGNYONG coupled with patrols indicate increased interest this area. Assembly of barges and log rafts this area point towards possible river crossing this night or</p>	G-2 Journal File 2d Div Entry #236

SECRET

SECRET

HEADQUARTERS SECOND INFANTRY DIVISION
WAR DIARY

260001 Aug 50 - 262400 Aug 50 Continued

Entry No	Time of Action	Authority	Action	Ref
-------------	-------------------	-----------	--------	-----

Entry 2 Continued:

early morning. Enemy activity in HILL 409 area has diminished. An attack along the NAKTONG RIVER valley forming the Division Southern Boundary is a possibility if an attack should be launched along the CHINJU-MASAN axis. An attack of regt size to be expected opposite CHANGNYONG can be expected at any time.

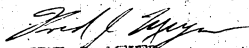
FRED A. MEYER,
Captain, Infantry,
Division Historian.

SECRET

SECRET

HEADQUARTERS SECOND INFANTRY DIVISION
WAR DIARY

270001 Aug 50 - 272400 Aug 50

Entry No	Time of Action	Authority	Action	Ref
1.		FOR #70 Hq 2d Inf Div	Heavy patrol activity by friendly units. Only two (2) of twenty-three (23) patrols received enemy fire. Composition of friendly forces changed to delete 19th RCT and 11th FA Bn.	G-2 Journal File 2d Div Entry #329
2.		PIR #3 Hq 2d Inf Div	Enemy Disposition: Unidentified regiment of the 10th rifle division SSE of SONJU on road to SONGJONG-DONG. Blm 10th Rifle Div, 29th Rifle Regt, and 27th Rifle Regt vic of OKYE-DONG, KAP'Ō-DONG, PYONGI-DONG SE of ALLIM-DONG respectively. Units presumed to be 9th Rifle Div vic of OSAN-NI. Hq 4th Rifle Div, 13th, 17th, & 16th Rifle regts of 4th Rifle Div, vic of PYONGCHON-NI, SINBAN-NI, CHUNGGYO-RI - PAEGYA-RI, SINCHEON-NI respectively. 104th (-) SP unit of regimental strength W of UIRYONG.	G-2 Journal File 2d Div Entry #313

Enemy Operations During Period: 25-35 barges and rafts brought to river line facing 9th Regt. Similar activity opposite 38th Regt front. Mvmt of tks coupled with artillery and tank fire primary enemy effort. Assumed 13th and 16th Regts 4th Div units involved. Concentration of enemy in vic. Enemy Div w/tentative identification as 9th assembling opposite CHANGNYONG.

Enemy losses: PW's: None Killed: 29 Wounded: 54

Enemy capabilities: Buildup in area around KYANGSAN opposite boundary of the 38th and 9th regts evident. Same indications in CHONGDONG are but to lesser degree. Presence of tks on east side of NAKTONG RIVER in vic of HILL 409 coupled w/construction of a sand bag bridge present possibility of an attack fr this area. Greatest pt of concentration of enemy troops and equipment in central sector. However NAKTONG RIVER VALLEY is natural route of approach which could be utilized by guerrillas moving with thousands of refugees moving east along the river. Continued buildup to be expected all along div front with an attack along either the CHONGDONG-CHANGNYONG axis or KYANGSAN-YONGSAN axis at any time.

Refugees: Check by 2d CIC Det indicated approximately 1,000 refugees from CHANGNYONG and YONGSAN area on the beach at SUSAN-NI. 2,000 to 3,000 more observed moving toward SUSAN-NI in area two miles to west. Conferences were held on 26 and 27 Aug in SUSAN-NI between 2d CIC Agents, Korean CIC, Korean National Police, and Korean Navy representatives. Screening of refugees at SUSAN-NI to be supervised by Korean CIC, KN Police and Korean Naval Intelligence agents. NYC members to provide security and police protection for refugees. Refugees arriving at SUSAN-NI to be taken to beach area to the east. After screening and segregation cleared refugees to be transported by small boats to SAMNANGJIN where they

SECRET

SECRET
HEADQUARTERS SECOND INFANTRY DIVISION
WAR DIARY

270001 AUG 50 - 272400 AUG 50 Continued

Entry No	Time of Action	Authority	Action	Ref
			Entry 2 Continued:	
			will be transferred to larger vessels to be taken to the island of KOJE-DO. Refugees not cleared to be taken to MIRYANG for further interrogation.	
3.		Journal Entry G-2 Section, 2d Inf Div	Refugees: Report from PM: "Progress of refugees enroute to CHONGDO. Head of column confirmed at 5000-6000 in camp in river bed. Main body extends for 9.2 miles old CHONGDO, SUBOK - SANJU - KASAN where there is another camp of 2000-3000 refugees. There are no refugees at YONGSAN."	

FRED J. MEZER,
Captain, Infantry,
Division Historian.

SECRET

SECRET

HEADQUARTERS SECOND INFANTRY DIVISION
WAR DIARY

260001 Aug 50 - 262400 Aug 50

Entry No	Time of Action	Authority	Action	Ref
1.			Operation of friendly forces: Continuation of heavy patrol activity. 23d RCT reverts to control of 2d Inf Div.	
2.		FIR #4 Hq 2d Inf Div	<p>Enemy Disposition: Hq 10th Div, 25th, 27th, 29th Regts disposed vicinity of OKKYE- DONG, MAWAL-DONG, KUMSONG-DONG, and KAEP'0-DONG west of NAKTONG RIVER. Div tentat- ively identified as 9th in area SSW of CHOGYE. Elements of 9th Div (?) in regt str disposed between the confluence of the EWANG and NAKTONG RIVERS S to confluence of RIVER and SIBANCHON. Another U/I unit of 9th Div located W of KYONGSAN. 18th, 16th, and 17th Regts of the 4th Div located vicinity of SIBAN-NI, SINCHON-NI, and CHEUNG- RI to PAEGYA-RI, respectively. Regt of SP 104 (-) still in vic of UIRYONG.</p> <p>Enemy Operations During Period: Increased enemy activity in S sector opposite bdy between 9th and 38th Regts. Increase in river crossing materials. Considerable enemy artillery activity with enemy patrols active. Eng activity increasing with artillery being dis- placed forward. These activities being confined to hours of darkness. Sporadic artillery fire on 9th and 38th Regt fronts with 9th receiving bulk of fire. Enemy troops crossed river and artillery drove them back across river. Within same area in space of few hours two other groups attempted crossings. All crossings were repulsed. Bridging equipment used in attacks 9th Regt area. Enemy using camouflage in increasing quantity.</p> <p>Enemy losses: PW's: None. Killed: 80. Wounded: 70.</p> <p>Enemy capabilities: Continued buildup of enemy units in S sector indicate that enemy may soon attempt to cross NAKTONG RIVER. Regtl units of 9th Inf Div identified w/sup- porting artillery regt. Loc of these units w/4th Div units opposite the HOPCHON- CHANGDONG-CHANGNYONG ave of approach further indicate an attack along this route. KYONGSAN-YONGSAN axis could be used as a secondary ave of approach. Use of NAKTONG RIVER valley not to be discounted. Possible route for enemy agents moving w/refugees. No attack from HILL 409 appears imminent. Enemy buildup may soon be accomplished which could result in a full scale attack across the NAKTONG along the most likely avenues of approach (HOPCHON-CHONGDONG-CHANGNYONG axis or along the route of KYANGSAN-YONGSAN). In en commits all forces presently available he is capable of severing lines of communica- tion.</p> <p>Refugees: Patrol by 2d CIC Det to SUSAN-NI located 7,000 refugees in SUSAN-NI area, with 4,000 refugees already screened during the 3 day pd ending 281300K. Approx 2,000 refugees awaiting trans from SUSAN-NI to SAENGIM MYON across river. Arrangements made to provide native female pers for performing physical search female refugees.</p>	G-2 Journal File 2d Div Entry #405

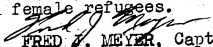

 FRED J. MEYER, Capt., Inf., Div Historian.

SECRET

HEADQUARTERS SECOND INFANTRY DIVISION
WAR DIARY

290001 Aug 50 - 292400 Aug 50

Entry NO	Time of Action	Authority	Action	Ref
1.		FOR #76 Hq 2d Inf Div	<p>Operation of Friendly Forces: Division boundaries as of 25 August restored. 3d BCT of 23d to be attached to 1st Cav Div for operational control and logistic support. effective 301200K August. 82d AAA, and 2d JM Co join Divisional Forces. 23d BCT assigned defensive sector in central area of Divisional Zone, from KOKCHOK-TONG S along the NAKTONG RIVER to MASUMON.</p> <p>Recon of defensive sector asgd 23d BCT (-) by 2d Div Cpn C 2, and mvmt of troops fwd to occupy front lines commenced 1200 hours 29 August 1950. 1st Bn, 23d BCT completed occupation of positions formerly occupied by 2d Bn, 38th Inf 291700 K Aug 50.</p> <p>Disposition of Enemy: Reported disposition of enemy units remains relatively unchanged w/tn exception of the Hq of the 4th Div in the vic of CHEUKCHON-NI and an unidentified In Div apparently assembling in area S of CHOGYE.</p> <p>Enemy Operations During Period: Negligible activity reported. Light patrolling with occasional artillery or mortar fire. Verification of enemy troops in valley running N and S near SONGSAN can not be obtained. Few vehicles and personnel observed this area. Air OP reported a section of MG near summit of HILL 409 with foxholes and 2-3 field pieces same vicinity.</p> <p>enemy losses: Casualties: 75</p> <p>Enemy Capabilities: Previously discussed courses of action remain unchanged. In the Northern Sector in the HILL 409 area no indication of an impending attack against the right flank exists; however, the enemy can build up his forces in this bridgehead at night unhindered at any time.</p>	G-2 Journal File 2d Div Entry #477

FRED J. MEYER,
Captain, Infantry,
Division Historian.

SECRET

SECRET

HEADQUARTERS SECOND INFANTRY DIVISION
WAR DIARY

300001 AUG 50 - 302400 AUG 50

Entry No	Time of Action	Authority	Action	Ref
1.		PIR #6, Hq 2d Inf Div	<p>Enemy Disposition: Hq 10th Div, 25th, 27th, 29th Regts disposed vic N of OKKYE-DONG, N of SONGJONG-DONG on SONGJU-HASAN-DONG road, KUMSONG-DONG, and KAEP'U-DONG respectively. U/I inf elements on HILL 409 SW of HYONGPUNG. Armored elements of brigade or regimental str tentatively identified as 105th in area S of CHOGYE. 16th, 16th, and 17th Regts of 4th Div w/hqs elements located as previously reported in vic of SINBAN-RI, SINCHON-RI, PABTYA-RI, and CHUKCHON-RI respectively. SP elements of regimental strength SE of SAMGA vic of TARO-RI. Undesignated inf regt vic of CHUNGAM-RI.</p> <p>Enemy Operations During Period: EUSAK reported the 105th Mechanized Brigade to have arrived in area SE of MYOPCHON in the SAMGA-SINBAN-RI river valley. This information not as yet confirmed by Div collecting agencies. Tactical Air did destroy one (1) tk in area. Front line activity along NAKTONG RIVER remained relatively quiet with one small group attempting to effect a crossing which was repulsed. In 38th Inf sector enemy patrol of 17 men attempted penetration of C Co area but were repulsed. 4,000 yds NW of HILL 409 Air OP reports existence of a possible enemy field hospital w/30-80 personnel lying outside exposed to observation.</p> <p>Enemy losses: P's 2 Casualties 28</p> <p>Enemy Capabilities: Buildup and rehabilitation pd of the 4th and 9th Inf Div nearing completion. Arrival of armor opposite Div sector indicates offensive action. Displacement of units on narrow front with artillery and mortars well forward further indicates this possibility. Present est str of enemy units HILL 409 sector indicate zone of probable secondary effort though enemy can reinforce area unhindered at night.</p> <p>Possibility of attack along NAKTONG RIVER valley toward SAMNANGJIN should receive less consideration because of inadequate road net and terrain making use of armor difficult.</p> <p>Enemy buildup and resupply pd should soon be over with early resumption of offensive to be expected probably along KYONGSAN-RI - YONGSAN axis and/or along the CHONGDONG-CHANGYONG axis in combination with efforts to infiltrate behind our lines.</p> <p>refugees: In the CHONG'DO area approximately 14,000 refugees have arrived in the collection camp at RA JON DONG with some 14,000 moving from HWAYANG vic KWAN HA DONG toward RA JON DONG. A report from the CHODONG MYON Korean National Police station at UBANG-RI is that 500 refugees from CHODONG MYON had been moved during 29-30 Aug to SUSAN-RI.</p>	G-2 Journal File 2d Div Entry #553

Fred V. Meyer
FRED V. MEYER, Captain, Infantry,
Division Historian.

SECRET

SECRET

HEADQUARTERS SECOND INFANTRY DIVISION
WAR DIARY

310001 Aug 50 - 312400 Aug 50

Entry No	Time of Action	Authority	Action	Ref
1.		FOR #79 Hq 2d Inf Div	2d Inf Div CP to move 1 Sep 50 from MAUN-NI area to Vic CHON-NI. Heavy frontal attack and artillery fire necessitated cancellation of operation MANGHU at 012055 Aug 50. At close of period elements of 2d Division under heavy attack.	G-2 Journal File 2d Div Entry #642
2.		PR 7 & 8 Hq 2d Div	Enemy Disposition: Recapitulation of enemy disposition as of 1800 hours 31 Aug 50: Hq 10th Div, 25th, 27th, 29th Regts disposed vic N of OKKYE-DONG, N of SONGJONG-DONG on SONGJU-TASAN-DONG road, YONGGYE-DONG, and KAP'U-DONG respectively. U/I elements on HILL 409 SW of HYONGPUNG. Elements of 105th Mechanized brigade disposed in vic of OSAN-NI and N of SINBAN-NI. Probable inf elements S of CHOGYE. 4th Div Hq, 18th, 16th, and 17th Regts vic of CHUKCHON-NI, N of SINBAN-NI, SINCHON-NI, and PABNYA-RI respectively. SP organization of regimental strength SE of SAMGA vic of TARO-RI. U/I units of regt str W of confluence of NAKTONG RIVER and SINBANCHON. Elements of U/I Inf Div in platoon str disposed vic of KYONGSAN-NI. Enemy Operations During Period: Negligible activity reported on Div front at this time. Enemy activity confined to small unit movement behind the front lines and entrenchment along the W bank of the NAKTONG, opposite the bulge area in the 9th Inf Sector. Traps and wps being well dug in and camouflaged. Enemy continuing to build boats and rafts on the NAKTONG. Largest enemy force sighted during period est Co located by a patrol opposite the 88th Inf Regt. Enemy succeeded in setting fire to one of our tanks after tank had thrown track. Nine hvy tanks reported by the 23d Regt in area with an unknown number of tanks observed by 9th Regt. Approx 150 new troops dug in in area opposite 9th Inf. North Korean forces opposite 2d Inf Div launched a coordinated attack commencing about 2330 31 Aug. Attack extended from the right flank of the 2d Div along the NAKTONG RIVER to the left flank of the 25th Inf Div. The NKS approached the river earlier beginning at approximately 2040 utilizing torches to march and forming the letters "V" and "O". Supported by artillery and mortar fire, the enemy crossed the NAKTONG RIVER in the 9th Regt area at two principal points and the 23d Regt area at three points. A lesser attack was mounted against the 38th Inf.	G-2 Journal File 2d Div Entries 634 and 720

SECRET

SECRET

HEADQUARTERS SECOND INFANTRY DIVISION
WAR DIARY

310001 Aug 50 - 312400 Aug 50 Continued:

Entry No	Time of Action	Authority	Action	Ref
			Entry 2 Continued:	

Enemy capabilities: Continue to attack along the YONGSAN-MIRYANG axis with forces presently available, estimated to be elements of three divisions supported by an undetermined amount of armor. Continuation of attack along the NAKTONG RIVER valley toward SAMNANGJIN. Continuation of attack along the CHONGDONG-CHANGYONG axis in an effort to split the division zone and the division MSR (main supply route). Continuation of attack from HYONPUNG, to envelope the Division right flank. Infiltrate large groups behind our positions, establish road blocks, cut lines of communication and isolate small units. The enemy will continue to attack to seize CHANGYONG and YONGSAN, bring up reinforcements, artillery and armor with view to further exploitation.

(Unit identified as the 105th Mechanized Brigade should be carried as the 105th Armored Division and the enemy division previously identified and carried as the 9th Rifle Division should be carried "unidentified".)

2.

Ltr AC of S
G-1 to CG
2d Div

Casualty figures for units of the 2d Inf Div from initial engagement of units up to and including 1800 hours 31 August 1950:

G-1, Staff
Section
Report
Attached

	Strength			Cumulative Casualties				Days in Action	
	Actual	Auth		Battle			Non		
	Off	EM	Agg	KIA	WIA	MIA	Tot	Battle	Action
9th Inf	145	2761	3793	105	550	172	827	419	24
23d Inf	151	3311	3793	14	51		65	115	15
38th Inf	152	3450	3793	12	26	2	40	59	10
H&A Stry DA	38	209	229		2		2	5	11
15th FA Bn	42	590	674	10	15	13	38	25	24
37th FA Bn	47	580	674	3	26		29	1	16
38th FA Bn	45	630	674					4	9
503 FA Bn	38	502	666					1	12
82 AAA Av Bn	41	721	778		4		4	6	11
72 Tr Bn	44	643	684					10	3
2d Eng C Bn	48	934	977						
2d Med Bn	43	286	341					5	

SECRET

SECRET

HEADQUARTERS SECOND INFANTRY DIVISION
WAR DIARY

310001 Aug 50 - 312400 Aug 50 Continued

Entry No Time of Action Authority Action Ref

Entry 3 Continued:

	Strength		Cumulative Casualties				Non Battle	Days in Action
	Actual	Auth	Battle		Tot			
	<u>Off</u>	<u>EM</u>	<u>Agg</u>	<u>KIA</u>	<u>WIA</u>	<u>MIA</u>		
2d MP Co	8	182	187				4	
2d QM	12	246	252				4	
2d Recon Co	7	165	171	1			4	7
702d Ord	20	297	321					
2d Div Band	2	94	70					
2d Repl Co	7	84	41					
Div Hq Co	16	158	189					
Div Hq Fwd	48	77	223					
Div Hq Rear	35	126						
Med Det Div Hq	2	13	15					
2d CIC Det	8	9	17					
528 MI Svc Plat	1	12	30					
Sig Co	15	353	369					
Tot Div	1015	16483	18914	145	674	187	1006	666

ROK Forces With Divisional Units

9th Inf	190			1	1		2	15
2d Div Arty	49							
Tot ROK Forces	239			1	1		2	15

Fred J. Meyer
FRED J. MEYER,
Captain, Infantry,
Division Historian.

SECRET

G-1

HEADQUARTERS
2d Infantry Division
Office of the AC of S, G-1

SECRET

17 September 1950

SUBJECT: Command and Unit Historical Report

TO: Commanding General
2d Infantry Division
ATTN: Div Historical Officer

I. NARRATIVE

1. The 2nd Infantry Division was alerted for O/S shipment to FECOM 8 July 1950. On and prior to this date the Division was authorized Reduction Table strength of 750 officers, 75 warrant officers and 13,769 enlisted men (about 15% less than T/O,) and actually had a slight over-strength in Company grade officers but was understrength in Field grade officers and EM. Normal attrition and heavy O/S levies tended to produce an increasing downward trend in division strength. Shortages were on requisition but due to the early shipping date of the division, other means were taken to obtain necessary personnel. Approximately 700 EM were obtained from non-alerted units at Ft Lewis and 1500 casual replacements at Ft Lawton awaiting shipment to FEC were diverted to the Division. Concurrently and with D/A approval, all PCS orders were revoked, leaves and furloughs cancelled, and TDY and enroute-to-join personnel were directed to report without delay. In addition 800 personnel were PCR qualified by the D/A directive which changed the ETS requirements from 31 October to 15 August. Meanwhile D/A orders had directed shipment of about 5,300 men from 21 armies to the 2nd Infantry Division. However, these replacements were given a late reporting date, with many authorized TPA, resulting in the 9th and 23d RCTs sailing short 300 and 800 EM, respectively. The last RCT, the 38th, was brought up to full T/O strength prior to departure and 1128 more EM were completely processed, equipped, and assigned to the 9th and 23d RCT's and brought along on the last ship to bring the total division shipping strength to near 100% of T/O with only about 80 officers (mostly WO unit administrators) and 50 EM short. Strength in the Division at the end of period covered by this historical report is reflected in detail in attached chart, (Incl 1.)

2. The Advance Detail consisting of the ADC and 9 staff officers left 21 July arriving in Korea on the 29th, spending 4 days at FEC headquarters enroute. The CG, 2d Div, followed shortly thereafter by commercial air, arriving in Japan on 31 July and in Korea on 3 August 50. The first elements of the division, the 9th RCT departed Puget Sound area on 17 July with subsequent shipments leaving practically each succeeding day. Last shipment, consisting of Division Headquarters and miscellaneous units departed 5 August. The entire Division had closed in Korea by 20 August.

SECRET

SECRET

3. Upon arrival of Division Headquarters, it was learned that the 9th and 23d RCT's had already been committed to battle resulting in 1038 battle and 452 non battle casualties, most of which were in the 9th Infantry. The 9th RCT (-) had been attached to the 24th Infantry Division and the 23d RCT was operating under Army control. 950 replacements were furnished the two RCT's from the replacements aboard the last ship. In addition 200 ROK troops were given to the 9th RCT. The 38th RCT which closed Pusan 19 August was committed to battle on 23 August when the Division relieved the 24th Infantry Division along the Nakdong River line. The Division was being heavily attacked at the close of the period.

4. Reports from all ships commanders indicated that morale and discipline while aboard ship was excellent with no serious problems arising. The Special Services supplied all troops with adequate supplies, of writing material, books, cards, etc. In addition libraries, nightly movies and skits and acts by passenger personnel were provided. The food was good and there was a minimum of seasickness. American currency was exchanged for military government certificates prior to debarkation. Since arrival in KOREA, gratuitous issue of supplies with the daily QM rations has been well received. A mobile PX system will soon become operational with priority given to front line units.

5. An Awards and Decorations Section has been established in the G-1 section of the forward CP and a board appointed to act on all recommendations received. Emphasis is placed on prompt review of all recommendations submitted, insofar as tactically possible. A decision to delegate responsibility of awarding all Purple Hearts to the medical section was made to include issuance of General Orders.

6. Postal service is adequate and the Division APO sends mobile money order teams to all units upon request.

7. Non-military public buildings are being utilized for shelter when available and considered appropriate. Sufficient tentage is otherwise available for unit command posts.

8. Unit Labor Officers, who are also Class A Agents, have been appointed in each major unit to expedite the hiring and payment of civilians employed within the Division. At present some 237 have been hired as interpreters, laborers and kitchen police.

9. To date, the Division has suffered a total of 1006 battle casualties, including 145 KIA, 637 WIA and 187 MIA. There have been 666 non-battle casualties. 24 POW's have been taken. Burials have been made in the 1st Cavalry Division Cemetery # 4 at Taegu and the 2d Infantry Division cemetery at Miryang. Approximately 25% of burials are unknown due to enemy practice of removing identification tags for propaganda purposes.

10. Battlefield promotions have been awarded: To ex-Sgts Jordan of the 9th Infantry on 25 August 50 and Vandy of the 38th Infantry on 26 August. Several others have been submitted by units for review. 11 Silver Stars and 17 Bronze Star medals plus numerous Purple Hearts have been presented personally by Major General HEISER, Commanding General of the Division.

II. PROBLEMS ENCOUNTERED AND SOLUTIONS THERETO

1. The movement of refugees has been the most serious civil affairs problem to date. Upon assuming control of our present sector on 24 August, some 50,000 to 60,000 refugees were concentrated on our front, constituting a serious threat to security and to supply and communication lines. However, aggressive action by G-2, the CIC and the Division FM with his attached Korean Police have resulted in the evacuation of most of these people from the Division zone, eliminating this problem for the present.

2. Initially, personnel reporting procedures were not satisfactory due to the arrival of the Division in increments and piecemeal attachments to various units. Now that nearly all units have returned to Division control this situation is gradually being rectified. Current reports are up-to-date, the main difficulty being consolidation of old reports for the time the division was separated and the back-log of Battle Casualty reports. The only solution to this problem lies in good communications and constant emphasis on prompt and accurate unit strength reporting.

III LESSONS LEARNED

The primary lesson learned is that a prompt and efficient system of supplying basically trained infantry replacements should be established to support such a combat operation as this Division is currently engaged in, since battle and non-battle casualties quickly sap the strength of the front line units unless replacements are immediately available.

1 Incl

1. Strength Chart

JAMES D. TANNER

Lt Col GSC

AC of S, G-1

SECRET

HEADQUARTERS 2ND INFANTRY DIVISION

G-1 Daily Summary No _____ as of 1800 31 Aug 50

UNIT	Strength		Daily Casualties						Cumulative Casualties					Gains		Prisoners of War							
	B	Auth Agg	Battle						Battle					Non Battlo	Days in action	Replac- e- ments	Retd to Duty	C.P.	Evac tated	On Hand	Total Taken	Total Enemy Dead	Other Losses
			K.	WIA	M.	C.P.	Total	K.	M.	M.	C.P.	Total											
a	o	e	d	e	f	g	h	i	j	k	l	m	n	o	p	q	r	s	t	u	v	w	x
Line 16 38 Inf																							
Special Units	60	192	1027								1			1	18								
Line 17																							
TOTAL 38 Inf	152	580	3793							12	26	2		40	57	10						7	
Line 18																							
Atchmnts 38 Inf																							
Line 19																							
Hq Hq Btry Div A	35	209	228											2	5	11							
Line 20																							
15 FA Bn	42	590	674							10	15	13		38	25	24							
Line 21																							
37 FA Bn	47	590	674							3	26	29			1	16							
Line 22																							
38 FA Bn	45	630	674												4	9						2	
Line 23																							
505 FA Bn	38	602	666												1	12							
Line 24																							
AAA Bn	41	721	779											4	6	11							
Line 2 5																							
72 Tk Bn	44	649	684												10	3							
Line 26																							
2 Eng Bn	48	971	977																				
Line 27																							
2 Med Bn	43	286	341												5								
Line 28																							
2 MP Co	8	182	189												4								
Line 29																							
2 QM Co	12	246	252												4								
Line 30																							
2 Ron Co	7	165	171							1				1	4	7							

SECRET

SECRET

G-1 Daily Summary No

as of 1800

31 Aug 50

HEADQUARTERS 2ND INFANTRY DIVISION

ROK FORCES	Strength		Daily casualties						Cumulative casualties					Casualties					Prisoners of War								
	Actual	Auth	Battle						Battle					Casualties					Prisoners of War								
	a	b	c	d	e	f	g	h	i	j	k	l	m	n	o	p	q	r	s	t	u	v	w	x	y	z	
Line 1																											
9th Inf	190									1	1				2	15											
Line 2																											
23rd Inf																											
Line 3																											
38th Inf																											
Line 4																											
2d Div Art	49																										
Line 5																											
72d Tk Bn																											
Line 6																											
2d Eng Bn																											
Line 7																											
Recon Co																											
Line 8																											
2d Med Bn																											
Line 9																											
Special Units																											
Line 10																											
TOTAL ROK FORCES	239									1	1				2	15											

SECRET

G-2

Narrative Summary

of

G-2 Section, Hq 2d Infantry Division

Prior to the receipt of information that the 2d Infantry Division had been alerted for possible overseas commitment in the Korean police action, the division had as a mission the normal security and counter-intelligence functions assigned to a garrison unit of Post, Camp, or Station, as well as the problem of training a tactical organization in intelligence procedures.

On 12 July 1950 per General Orders Number 1, Headquarters Fort Lewis, Washington, the consolidation of Headquarters Fort Lewis and Headquarters 2d Infantry Division, as announced in Paragraph II, General Orders Number 63, dated 16 November 1949, was discontinued effective as of 0001 hours 12 July 1950. All matters pertaining to other than the 2d Infantry Division or alerted units were, in the future, to be referred to the Commanding General, Headquarters Fort Lewis, Washington.

Personnel were requisitioned to fill the vacancies created by previous reduction tables; this was a difficult task as trained personnel with the appropriate skills were scattered in military installations throughout the United States. It wasn't until a few days before shipment that sufficient qualified personnel were received to fill these vacancies. The G-2 Section

was now brought to a ~~strength~~ ^{SECRET} of eleven officers and sixteen enlisted men.

The 528th Military Intelligence Service Platoon was attached to the 2d Infantry Division but arrived at Fort Lewis minus personnel and equipment. Through a series of TWXs, efforts were made to establish and clarify the status of this unit. The initial action had been promulgated by TWX from the Department of the Army establishing the T/O&E and respective sections under which the 528th Military Intelligence Service Platoon was to be organized, and further transferred the unit less personnel and equipment from Fort Bragg, North Carolina, to Fort Lewis for attachment to the 2d Infantry Division and further relieved the unit from assignment to the Third Army and assigned it to Sixth Army. The same TWX indicated that movement directive WAR 85464, dated 11 July 1950, was being amended to include the 528th Military Intelligence Service Platoon.

To obtain personnel to fill the complement of the 528th Military Intelligence Service Platoon, personnel of the Post were screened for appropriate MOSs and G-2, Sixth Army, was requested to locate qualified officer and enlisted personnel.

When the organization finally boarded ship on 5 August 1950 it had received one officer and nine enlisted personnel and while in transit four additional enlisted personnel were assigned from replacements being carried by the division.

The newly reorganized G-2 Section called for the addi-

tion of four IPW Teams, ~~however~~ ^{SECRET}, these teams were never filled with personnel and all IPW work was performed by the 8088th Language Detachment (Provisional) which was attached to the 2d Infantry Division from the 166th Military Intelligence Service Detachment located in Japan.

The Commanding Officer of the 166th Military Intelligence Service Detachment was instructed to take the necessary action to prepare the 8088th Language Detachment (Provisional) for movement to Pusan, Korea, by Movement Order No. 78, Headquarters Eighth Army, APO 343, this included obtaining qualified personnel to fill the TO of the organization. To accomplish this, two officers and eleven enlisted personnel were relieved from assignment with the 7th Infantry Division, APO 7, and assigned to the 166th Military Intelligence Service Detachment, and the 16th Military Intelligence Service Detachment, Yokohama, Japan. From these organizations the personnel were placed on PDY for an indefinite period for duty with the 8088th Military Intelligence Service Detachment (F).

After a short lived existence, the 8088th Military Intelligence Detachment (F) was discontinued by Section II, General Order, Number 207, Headquarters Eighth Army, 11 August 1950; all equipment, supplies, and records were retained by the 2d Infantry Division.

Personnel who were carried in a detached service status to the 8088th Military Intelligence Service Detachment (F) were relieved from such attachment and reassigned to the 2d Infantry

Division, this was accomplished by orders published by Headquarters Eighth Army.

Three officers of the unit were assigned to the G-2 Section while the eleven enlisted personnel continued to operate under control of the G-2 Section.

To provide for Counter-intelligence support, the 2d CIC was relieved from assignment to the 115th CIC Detachment, Sixth Army, Presidio of San Francisco, California, and assigned to the 441st CIC Detachment in Japan. The unit which was attached to the 2d Infantry continued its attachment and prepared to ship with the division.

Initially, the organization was not included on the Divisional Shipping List. Despite the omission, however, the unit was readied for movement. The division shipping list was finally amended to include the 2d CIC Detachment.

Providing for counter-intelligence support to the Regimental Combat Team commanders, two agents were attached to each Regimental Combat Team to ship with the unit. In addition, the executive officer and one agent acting in the capacity of an advanced echelon for the detachment headquarters travelled with the 9th Regimental Combat Team with instructions to join the AC of S, G-2, in Korea and set up arrangements for the main body which departed Fort Lewis, Washington, on 5 August 1950 with the remaining elements of the division.

Upon arrival in Korea of the CIC Detachment Headquarters all agents were brought back under its operational control for

further orders.

Since that time the 2d CIC Detachment has provided counter-intelligence support in accordance with provisions of applicable Army and theater directives. This has entailed a dual responsibility.

With the completion of the organization of the G-2 Section, an internal SOP was prepared outlining the responsibilities and duties of personnel and sub-sections.

In conjunction with the Internal SOP for the G-2 Section, Section III "Intelligence", of the 2d Division SOP dated 25 August 1949, was rescinded. A new Section III was prepared to physically replace the old one. Within this SOP the essential elements of information, collection, evaluation, and dissemination, reconnaissance and observation, reports, patrols, reconnaissance company, division engineers, service units, counter-intelligence corps detachment, counter-intelligence, passwords, prisoners of war, captured documents, captured materiel, maps, and other miscellaneous data were considered.

When the organization of the G-2 Section neared completion, efforts were made to instruct personnel in their duties and weld them into a cooperative working component. The internal and divisional SOPs were studied and discussed. Furthering this training a schedule was prepared for use while in transit to cover administrative and operational functioning of the unit. All personnel also receive instruction and were schooled in the requirement of their basic arm and other arms within their

section; after preparatory training was completed familiarization firing was conducted.

Lieutenant Colonel Gerald G Epley, AC of S, G-2, left Fort Lewis, Washington, for Fairfield-Suisun, AFB, California, on 20 July 1950 with the Division Advance Party. They arrived in Tokyo on the 25th of July and proceeded immediately to GHQ where, after briefing on the latest developments in the Korean War and consultation with the heads of the respective staff sections, the party left for Korea to get a first hand view of existing conditions and to prepare for arrival of the division.

On 5 August 1950 when remaining elements of the division departed from the United States aboard the USS General Leahy, the main body of the G-2 Section with its attached elements under the jurisdiction of Major Wallace W Wilkins, Jr., Executive Officer of the Section, was aboard.

On arrival at Pusan, Korea, on 19 August 1950 the organization remained aboard ship until the following morning debarking on the 20th. The section split into two groups, one took the G-2 equipment to Miryang by motor convoy, the other group took a train, arriving at Miryang late in the afternoon.

In the meantime, arrangements were being made for the 2d Division to relieve the 24th Division and a liaison group established contact with the 24th to familiarize itself with the tactical situation.

At the time the G-2 Section entered the operational phase enemy activity consisted of probing actions along the

division zone; patrolling and infiltration were the principal tactics employed. Soldiers were intermingling with refugees which presented a security problem which had to be eliminated. At 1050 hours of the 25th, psychological warfare pamphlets were dropped in enemy held territory east of the Naktong; this area is known as Hill 409 and during the succeeding days presented a continuous threat to division operations.

Starting on the 25th, the intelligence pattern began to change and indications of enemy capabilities of crossing the Naktong River opposite the 9th and 38th Regiments became increasingly evident as engineer groups appeared and were observed constructing rafts while many small enemy groups were observed along the west bank of the river.

Upon initial commitment of the division the intelligence picture of enemy supply and troop disposition was very sketchy and to the best of available knowledge the 2d Division was faced with elements of the 27th Infantry Regiment, 29th Infantry Regiment (less 1st Battalion) belonging to the 10th Rifle Division, additional unidentified elements of the 10th Rifle Division, and the 16th, 17th, and 18th Regiments of the 4th Rifle Division, plus unidentified heavy weapons and armored units.

On the 26th and 27th of August, the enemy's efforts were confined to the 9th and 38th RCT fronts. An increase in barges and rafts appeared in front of the 9th RCT with tanks, artillery, and signal flares indicating intense enemy

SECRET

activity. The evidence of enemy concentrations increased and an enemy division tentatively identified as the 9th began assembling opposite the Changnyong sector. Increased activity appeared in the vicinity of Hill 409 with the presence of tanks east of the Naktong River, with the possibility of an attack from that sector.

New enemy unit identifications were made, an unidentified regiment of the 9th Division at Yongdong-ni; another at Soeck-ri, possible artillery unit at Hyopchon, and a new unit at Soam-ri.

On the 28th and 29th of August there was little enemy activity other than light patrolling and occasional artillery and mortar fire.

On the 29th and 30th reports were received that the 105th Mechanized Brigade had arrived southeast of Hyopchon in the Samga-Sinban-ni River valley, however, at this date it had not been confirmed by division collection agencies. The enemy build-up and resupply period appeared to be complete and resumption of the offensive was expected along the Kyongsan-Ri-Yongsan axis and/or along the Chondong-Changnyong axis combined with efforts of guerrillas behind the lines.

At 2330 hours, 31 August, the enemy finally launched the expected offensive extending from the right flank of the 2d Division along the Naktong River to the left flank of the 25th Infantry Division. The enemy employed torches as signals, forming the letters V and O. The enemy, supported by mortar

and artillery fire, crossed the Nakdong River in all sectors of the 2d Division zone. At the close of the reporting period the enemy forces were achieving many successful penetrations and it was evident that an all-out attack had been launched with the destruction of the entire front and a continuation of the drive to Pusan as a final objective.

xxx

G-3 & Avn Sect

G-3 Staff Section Report is incorporated with the Divisional Narrative Summary.

All G-3 supporting documents were destroyed through enemy action in the vicinity of Kunu-ri, Korea.

ARMY AVIATION SECTION
HEADQUARTERS COMPANY
2ND INFANTRY DIVISION
A.P.O. 248 c/o P.M.
SAN FRANCISCO, CALIFORNIA

SECRET

July 1950

The 2nd Infantry Division was alerted on 8 July 1950, for movement overseas to Korea. Immediately, all of the Army Aviation Section within the division began preparing planes and equipment for shipment. After a conference among the pilots, it was recommended to the Commanding General through channels that only planes of one type, the L-16, be taken to Korea. This was recommended for three reasons. First was the supply of parts. Parts for three types of aircraft, the L-16, L-17, and H-13, would overtax our limited amount of T&E vehicles. Second was the fact that in our opinion neither the L-17 nor H-13 was suitable for combat. The third reason was the excessive amount of maintenance required for the H-13. The Commanding General agreed with the recommendation but we were then short of our T/O strength of liaison aircraft. Four (4) L-16s were flown in from California but were found to be in such a state of repair as to be unfit for any further use without a complete overhaul. Then six (6) more L-16s were flown in from the East which were promptly crated and loaded.

At the same time, several pilots were transferred from other units at Fort Lewis to give us the necessary T/O strength in pilots.

Since the Division Headquarters Company Army Aviation Section was scheduled to be the last to leave, the section spent considerable time helping to crate and load the Artillery Air Section planes and equipment.

All of the available necessary supplies were procured and equipment overhauled during this period.

SECRET

ARMY AVIATION SECTION
HEADQUARTERS COMPANY
2ND INFANTRY DIVISION
A.P.C. 248 c/o P.M.
SAN FRANCISCO, CALIFORNIA

1 August 1950

R O S T E R

1. The following named personnel listed below were with the Army Aviation Section on 1 July.

a. Officers

<u>NAME</u>	<u>RANK</u>	<u>ASN</u>
Hoffman, Robert L. Div. Aviation Officer	Capt.	01176669
Armstrong, Hilbert L. CO, Army Aviation Section	Capt.	0405007
Lawrence, George H.	Capt.	01283798
Baugh, Wilford A. Jr.	1st. Lt.	01339340
Larohn, Ralph L.	1st. Lt.	01181947
Richards, Barton F.	1st. Lt.	060471
Roush, John W.	1st. Lt.	01320186
Thompson, Hubert A.	1st. Lt.	01306175

b. Enlisted Men

<u>NAME</u>	<u>RANK</u>	<u>ASN</u>
Flowers, Clarence R.	Sgt.	RA 13114563
Reiser, Bruce D.	Sgt.	RA 39614833
Brosnahan, Donald J.	Cpl.	RA 16321543
Cathcart, Charles W.	Cpl.	RA 19291780
Hightower, Oscar E.	Cpl.	RA 14065719
Minnis, Charles E.	Cpl.	RA 19329305
Nichols, Ralph L.	Cpl.	RA 33968243
Towell, James R.	Cpl.	RA 34369905
Raen, Roger N.	Cpl.	RA 39462038
Thompson, John I.	Cpl.	RA 14324421
Kalk, Robert L.	Pfc.	RA 36924520
Stinnett, Johnnie E.	Pfc.	RA 18214389
Thomas, Dewellyn	Pvt.	RA 13253095

2. The following named personnel listed below joined the Army Aviation Section after 1 July.

a. Officer & Enlisted Men

<u>NAME</u>	<u>RANK</u>	<u>ASN</u>
Ryan, Thomas F.	1st. Lt.	0472142
Heifner, Claude C.	Sgt.	RA 18060186
Holland, Elvage	Sgt.	RA 34547172
Zadai, William J.	Cpl.	RA 13349967
Marinick, Nicholas L.	Pfc.	RA 12306920

ARMY AVIATION SECTION
HEADQUARTERS COMPANY
2ND INFANTRY DIVISION
A.P.O. 248 c/o P.M.
SAN FRANCISCO, CALIFORNIA

SECRET

August 1950

The 2nd Infantry Division Army Aviation Section spent the time before embarkation, cleaning up last minute details and checking equipment. On 5 August 1950 the section with Division Headquarters Company loaded on board the USMT Gen. Am Greeley at the Navy pier at Tacoma, Washington. The ship sailed at approximately 1530 hours the same day. The trip was uneventful except for one day of rough weather. The time aboard was spent on physical training, instruction on weapons, and familiarization on firing from the fantail.

The ship docked at Pusan on 19 August 1950 and the section disembarked early on the morning of 20 August 1950 and were moved to Hialeah race track area where we picked up our vehicles. We found that we were one 4x4 vehicle short. It had been stolen the day before we docked. Our planes were in the same area and the section immediately started work uncrating and erecting.

The first flight for the section in Korea was flown by Lt. Ralph L. Krohn with Sgt. Clarence Flowers in a plane borrowed from the 503rd FA. Co. This mission was in search of a group of unidentified armed men in the vicinity of Pusan. Results were negative.

One of the pilots in Division Artillery had hit a wire and cracked up his airplane. Division Artillery had procured an L-17 which was traded to us for one of our L-16s. Lt. Hubert A. Thompson was assigned to this ship and on 21 August, proceeded to Miryang to be on call for the Headquarters there.

On 22 August Lt. Barton F. Richards and Lt. Krohn had their planes assembled and proceeded with their mechanics, Cpl. Donald J. Brosnahan and Sgt. Charles Guthart to Miryang to fly for Division Headquarters.

The rest of the section completed erection and testing of the aircraft and moved to Miryang on 24 August. We moved in on the strip which had been built by the 24th Infantry Division. We also used the road pick up strip at Taumenal which the 24th Division had set up. This was used to pick up and drop passengers and observers.

SECRET

On 27 August, Lt. John W. Roush and his mechanic, Opl. Roger N. Raaen, were sent to Task Force Bradley at Pohang Dong to observe and adjust both artillery and naval gunfire. On the same day Lt. Milford A. Baugh Jr. and his plane were placed on detached service to relieve the pilots of the 15th FA. Bn. who had been flying as high as twelve hours per day for over a month.

During the period from 23 August to 31 August, the remainder of the section under the command of Capt. Gilbert L. Armstrong was flying missions of many kinds, of which some were observation and reconnaissance flights. Photographers from 2nd. Signal Company were taken over the front for pictures of Hill 409. At the same time many flights were made flying couriers, and in one instance, oxygen was flown from Pusan when an ambulance from the 8076th Surgical Hospital was ambushed and the regular supply of oxygen was lost. This saved the lives of at least three patients. Lt. Hubert A. Thompson was assigned as personal pilot to General Keiser. He flew not only General Keiser on his business but members of his staff also.

The flights at the end of this period are as follows:

FLIGHTS BY TYPE	NUMBER FLIGHTS
C-2	21
C-4	1
C-21	56
C-22	1
C-27	110
C-28	9

Lt. Roush flew 15 missions while on D.S. at Pohang Dong for Task Force Bradley.

ARMY AVIATION SECTION
HEADQUARTERS COMPANY
2ND INFANTRY DIVISION
A.P.O. 248 c/o P.M.
SAN FRANCISCO, CALIFORNIA

SECRET

August 1950

D I A R Y

- Sat. 19 Aug 50: The Second Infantry Division Army Aviation Section landed at the docks of the Southern Korean City of Fusan in the late afternoon. The night of the 19th. was spent aboard ship since I was late arriving into port.
- Sun. 20 Aug 50: Reveille was at 0430 with breakfast at 0500. There were church services at 0600 by both Catholic and Protestant Chaplains. At 0730 there was a band concert by the South Korean Army Band, Area Army Band, and 2nd Div. Band. We disembarked at about 0930. We proceeded by truck to the staging area for our vehicles. We had one 1/4 ton 4x4 vehicle stolen from us just before our arrival. The staging area and our air strip were in the same area. This strip was located at the Hialeah race track. The Division Artillery had already arrived some days before and had fixed up a runway of steel matting. It was long enough that a L-17 Navion could land on it. Our planes were already there and still in the crates. We had a good bath at an engineer outfit plus a hot supper. We moved into a wooden building which was later cleaned up. Lt. Ralph L. Marohn and Sgt. Clarence Flowers made the first flight of the section. The plane was borrowed from the 503rd. FA. Bn.
- Mon. 21 Aug 50: We started to uncrate the aircraft had began to assemble them for flight. The boys worked very hard to get this job accomplished and as we finished an aircraft the pilot would test hop it. The pilots all helped to assemble their own planes. A couple of the boys located a place that beer and coco cola was sold. We got several cases of each plus some ice to cool it with. We continued to eat at the Engineers. Lt Thompson went to Miryang with the L-17, we procured from DivArty for a L-16, to fly for Div. Hqs.
- Tue. 22 Aug 50: A second day was spent in assembling the aircraft and test hopping of the same. DivArty moved to Miryang today. We put out our own security on the 21st. and continued it for several days. We now began to eat our chow with RMAG, Korean Military Advisory Group, at their compound. Lt. Richards, Lt. Marohn, Cpl. Cathcart, and Cpl. Brosnahan went to Miryang to fly for Div. Hqs.
- Wed. 23 Aug 50: Our aircraft are all flying now. The Captain let the local people come in and take the wood from our shipping crates away with them. The sight they made tearing the crates up was one to remember. Several pictures were taken by the officers and men alike. Women and children were fighting over the wood and it was really a rat race. We prepared to move our equipment the next morning to Miryang. We made several trips to town for presents and the like.
- Thu. 24 Aug 50: Our planes had already gone ahead of us. We moved out in convoy with Captain Lawrence in the lead. One truck had a couple of flats on the way with the change of different sized tires at the last time of the blow out.

SECRET

Thu. 24Aug50: Con't.

Truck #42 (Gravel Bertie) hit the ditch but was out on its own power. We lost one gas can from the side of the truck and dented the bed abit. Nothing serious happened on the trip but the road was rough and had many curves. As we neared the lower part of the Naktong River it looked very much like the Mississippi River in the States. The water was a deep blue and the rice fields were very green. We finally arrived in Iryang at the airstrip to find that DivArty and the 24th Div. Air Section was already set up for business. Captain Armstrong, CO of the section, had procured for us a squad tent which was put up in the dark and rain by the section. The mast poles were attached to two of the trucks which acted as the base for the whole thing. The tent was then staked down all around to keep the wind from blowing in. We finally got to bed and it was well earned. There were several flights made today before the arrival of the section. Lt. Thomson flew Maj. Gen. Keiser for a local hop.

Fri. 25Aug50: We set about getting things ready for the morning flights and looking around our new home. We found that we were at a Southern Korean Army Hospital. We had several C-21 and C-27 flights today. Our equipment was being put into order so that we could use it. Our Korean helpers, that we brought from Fusan with us, went to work on our clothes while we found a place to eat. We located the Service Btry. of the 37th FA. Bn. but we had to ford a river to get there. It was well worth crossing the river for such good chow. Our runway was very good and one of the best so far.

Sat. 26Aug50: The 24th Div. Air Section moved out and we moved into their old place across the parking area. We had accumulated two C.P. tents and a large ship hole cover. We set up the squad tent for the officers and the two C.P. tents for operations and Captain Armstrong. The big hole cover was then hoisted by a single mast and looked very much like a circus tent. The enlisted men moved into this one. There still wasn't enough room for all even though we crowded all of them in. The supply section and radio section moved into a shelter they had built next to the supply truck and ravelment. It sheltered four men which enlightened the load in the hole cover. We finally settled down to a somewhat normal routine and had several C-21 and C-27 flights all day long. So ended another day of rushing.

Sun. 27Aug50: This was the beginning of the second week in Iorsa. Some of the boys visited the Korean Military Hospital and our Medic has started to work over there at night time. Div. Arty left for the forward strip and we had one pilot and plane (Lt. Rauch/999) D.S. to the 15th. FA. Bn. One other pilot, mechanic, and plane (Lt. Roush, Cpl. Knaen/998) D.S. to Task Force Bradley at Ichang-dong. This lightened the room space in the big tent also.

Mon. 28Aug50: This was a normal day for everyone. The Doc procured a wall tent and so did the section chief. Some of the boys moved into those tents to help the shortage of space. Our gook boys continued to wash our clothes and do odd jobs around the area. There was about a dozen flights made on this day. Some were to the front and others were just administrative. In the afternoon the boys went down to the river for a bath. The water was abit cool but the swim was fun anyway. The chow is very good and "PARRY" at the 37th, really knows how to cook. A/C 98 and 999 still D.S. to respective units.

SECRET

Tue. 29 Aug 50: There were eleven flights today. Some were photographic missions and the others were the usual observation and administrative missions. The work around the area continued in routine. The boys had a good swim at the river. It really feels funny to strip down and go in with so many people around watching you. Several of the boys began buying eggs and apples from the local people. The Medic continued to help the Korean Army Doctor with his work at night. Still think Doc was trying to make points with the nurse. He is doing good work also. Our boys donated candy, and cigarettes to the hospital for the wounded Korean soldiers and also any equipment that was needed and was on hand. Chow was as good as usual. Lt. Baugh, Lt. Roush, and Cpl. Hansen are still on D.S. to the respective units. Some trips were made to town for odd items of interest to the boys.

Wed. 30 Aug 50: This was a normal day of operations. The usual amount of flights were made to the front. Capt. Armstrong flew to Taegu in a morning flight and Capt. Lawrence followed with Lt. Lombardo in the early afternoon. The photographers from 2nd Signal Company went by plane to Hill 409 for some pictures of the area. The work around our area was as usual. One of the planes was used as a courier for sometime. Lt. Wilford A. Baugh Jr. returned from D.S. with the 15th PA. Bn. Was glad to see him back. Lt. John W. Roush was still on D.S.

Thur. 31 Aug 50: Lt. Baugh made an emergency flight to Pusan for some oxygen needed by the 8076th Surgical Hospital at Miryang. The regular supply was lost when the ambulance was ambushed bringing it from Pusan. The oxygen that was flown saved at least three lives of boys in a critical condition. Capt. Armstrong flew to Pohang-dong with Col. Ellis on business. Several other flights were made including one flight with Maj. Gen. Kaiser and Lt. Thompson as his personal pilot. Lt. Thompson not only flew the general but members of his staff also.

SECRET

ARMY AVIATION SECTION
 HEADQUARTERS COMPANY
 2ND INFANTRY DIVISION
 A.P.O. 248 c/o P.M.
 SAN FRANCISCO, CALIFORNIA

SECRET

August 1950

Sun. 20 August 50: Landed Pusan, Korea.
 2000- Investigated area for armed men in vicinity of Pusan. Investigation was negative. Borrowed aircraft.

Mon. 21 August 50:
 Assembled and test hopped aircraft.

Tue. 22 August 50:
 Assembled and test hopped aircraft.

Wed. 23 August 50:
 Advanced party made admin. flights.
 1000- C-21 for Ivanhoe C.I.C.
 1000- C-21 for Ivanhoe Engineers
 1500- C-21 for Ivanhoe Engineers
 1830- C-28 in vic. of Hill 409 (2 flights)

Thu. 24 August 50: Moved- Pusan to Miryang.
 C-27 and C-21 flights from Miryang

Fri. 25 August 50:
 C-27 and C-21 flights from Miryang

Sat. 26 August 50:
 C-27 and C-21 flights from Miryang

Sun. 27 August 50:
 1 plane, pilot, and mechanic D.S. to T.F. Bradley.
 1 plane and pilot D.S. to 15th. FA. Bn.
 C-27 and C-21 flights from Miryang.

Mon. 28 August 50:

L-16	#455	Lawrence	0700	Front	Observation	C-21
L-16	#805	Richards	0830	Front	Observation	C-21
L-16	#996	Marohn	0710	Ivory strip	Trans/freight	C-27
L-16	#458	Thompson	0740		Ivanhoe #6	C-27
L-16	#451	Ryan	0740	Rd. strip	Lombardo	C-27
L-16	#455	Armstrong	1025	Pickup strip		C-27
L-16	#451	Ryan	1100	Pickup strip		C-27
L-16	#805	Richards	1110	Pickup strip		C-27
L-16	#455	Lawrence	1325	Pickup strip		C-27
L-16	#805	Richards	1430	Pusan		C-27
L-16	#996	Marohn	1715	Recon	Observer	C-21
L-16	#998	Roush	D.S.	Pohang		
L-16	#999	Baugh	D.S.	15th. FA. Bn.		

Tue. 29 August 50:

L-16	#451	Ryan	0740	Front R/S	Observer	C-21
L-16	#458	Thompson	0715	Pickup strip	Ivanhoe #6	C-27
L-16	#455	Armstrong	0900	Rd. strip		C-27
L-16	#805	Richards	1035	Fwd. Rd. strip	Observer	C-21
L-16	#455	Lawrence	1310	Front R/S	Observer	C-21
L-16	#451	Ryan	1330	Ivory strip	LaPare	C-21
L-16	#452	Armstrong	1145	Pusan		C-27
L-16	#996	Marohn	1515	Front R/S	Observer	C-21
L-16	#805	Armstrong	1400	DivArty A/strip		C-27

Tue. 29 August 50: Con't.

L-16	#996	Marohn	1810	Front	Observer	C-21
L-16	#455	Armstrong	1830	Front R/S	Observer	C-21
L-16	#998	Roush	D.S.	Pohang		
L-16	#999	Baugh	D.S.	15th. FA. Bn.		

Wed. 30 August 50:

L-16	#805	Richards	0830	Fwd. Rd. Strip		C-21
L-16	#458	Thompson	0715	Rd. strip	Ivanhoe #6	C-27
L-16	#455	Lawrence	0730	R/S & Front	Observer	C-21
L-16	#451	Ryan	1300	R/S & Front	Observer	C-21
L-16	#996	Armstrong	0920	R/S & Taegu		C-27
L-16	#455	Lawrence	1120	Fwd. strip	Searle	C-22
L-16	#455	Lawrence	1315	Taegu	Lombardo	C-27
L-16	#996	Marohn	1330	Fwd. strip	2, 9th Inf. Obr.	C-21
L-16	#805	Richards	1515	Fwd. strip	2 Observers	C-21
L-16	#451	Ryan	1650	R/S & Index	Fitzgerald	C-27
L-16	#996	Marohn	1510	Front	GHQ Photog.	C-26
L-16	#998	Roush	D.S.	Pohang		
L-16	#999	Baugh	D.S.	15th. FA. Bn.		

Thu. 31 August 50:

L-16	#996	Armstrong	0830	Fwd. pickup strip	2 Observers	C-21
L-16	#455	Armstrong	1030	Pohang	Col. Ellis	C-27
L-16	#996	Baugh	0625	K-1	Energ.-Oxygen-Hosp.	C-27
L-16	#451	Ryan	0800	DivArty	Observer	C-21
L-16	#458	Thompson	0720	Rd. strip	Ivanhoe #6	C-27
L-16	#805	Richards	0930	Rd/S & Pusan	Ivanhoe #14	C-27
L-16	#996	Marohn	1030	Index R/S	Tank Co. Co.	C-27
L-16	#999	Baugh	1600	Ivory R/S	1 passenger	C-27
L-16	#805	Richards	1635	Ivory 409	Impal, 3 Observers	C-21
L-16	#999	Roush	D.S.	Pohang		

HEADQUARTERS 2D INFANTRY DIVISION
A.P.O. 248 % Postmaster
San Francisco, California

1 September 1950

SUBJECT: Monthly Report of Aviation Activity

TO : Commanding General
Eighth United States Army in Korea
APO 301 % Postmaster San Francisco, California

ATTN : Army Aviation Officer

1. In compliance with verbal instructions, your headquarters, the following report is submitted for the month of August, 1950.

a. T/O Officer Aviator Personnel:

UNIT	NAME	GRADE	ASN	CAT	FLIGHT TIME		TOTAL
					DAY	NIGHT	
Hq 2d Div	Hoffman, Robert L.	Capt.	01176669	III	6:00	0	6:00
Hq Co 2d Div	Armstrong, W.L.	Capt.	0405007	III	10:00	0	10:00
	Lawrence, G.H.	Capt.	01283798	III	11:00	0	11:00
	Baugh, W.A. Jr.	1st. Lt.	01339340	III	33:00	0	33:00
	Marohn, R.L.	1st. Lt.	01181947	III	20:00	0	20:00
	Richards, B.F.	1st. Lt.	060471	RA	24:00	0	24:00
	Roush, J.W.	1st. Lt.	01320186	III	33:00	0	33:00
	Ryan, T.K.	1st. Lt.	0472142	III	19:00	0	19:00
	Thompson, H.A.	1st. Lt.	01306175	III	18:00	1:00	19:00
Hq Div Arty	Hannons, T.B.	Capt.	01182130	III	53:20	0	53:20
	Kolb, R.W.	Capt.	01287898	III	45:50	0	45:50
	Lewis, L.E.	1st. Lt.	059904	RA	43:45	0	43:45
38th FA. Bn	Aure, G.O.	1st. Lt.	01184616	III	48:25	0	48:25
	Guffey, K.C.	1st. Lt.	01118723	III	54:50	0	54:50
15th FA. Bn	Littall, J.L.	1st. Lt.	01174632	III	143:45	0	143:45
	Valdez, I.S.	1st. Lt.	01997748	III	132:20	0	132:20
503rd FA. Bn	Hopkins, P.F.	1st. Lt.	02019744	III	59:30	0	59:30
	McLbridge, R.	1st. Lt.	01173514	III	60:40	0	60:40
37th FA. Bn	Black, W.B.	Capt.	01166438	III	83:30	0	83:30
	Morrow, C. Jr.	1st. Lt.	058983	RA	82:50	0	82:50

SUBJECT: Monthly Report of Army Aviation Activity

UNIT	NAME	GRADE	ASN	CAT	FLIGHT TIME		TOTAL
					DAY	NIGHT	
b. Non T/O Officer Aviator Personnel							
37th FA. Bn	**Hume, T.A.	Major	023981	RA	0 0	0 0	0
	#Kinley, G.L.	Capt.	01185024	READ	0	0	0
15th FA. Bn	**Baxter, L.G.	1st. Lt.	01184983		1:45	0	1:45
	#Teitlebaum, R.J.	1st. Lt.	01180071		3:25	0	3:25
	#Hanselman, W.E.	1st. Lt.	01169554	READ	4:20	0	4:20
503d FA. Bn	Stewart,	1st. Lt.			0	0	0
	Williams, B.C.	1st. Lt.	01182304	READ	0	0	0

- * Indicates helicopter-trained aviators.
- ** Indicates rotated to ground duty.
- # Indicates aviators on competitive tour.

c. Listed Men

UNIT	NAME	GRADE	ASN	
Hq Co, 2d Div	Flowers, Clarence R.	Sgt.	RA 13114563	
	Heifner, Claude C.	Sgt.	RA 18060186	
	Holland, Elvage	Sgt.	RA 34547172	
	Reiser, Bruce D.	Sgt.	RA 39614833	
	Brosnahan, Donald J.	Cpl.	RA 16321543	
	Cathcart, Charles W.	Cpl.	RA 19291780	
	Hightower, Oscar E.	Cpl.	RA 14065719	
	Kinnis, Charles E.	Cpl.	RA 19329305	
	Nichols, Ralph M.	Cpl.	RA 33968243	
	Niebel, Paul W.	Cpl.	RA 18046148	
	Nogalmeier, LuVerne W.	Cpl.	RA 39499451	
	Rosen, Roger N.	Cpl.	RA 39462038	
	Thompson, John P.	Cpl.	RA 14324421	
	Zadal, William J.	Cpl.	RA 13349967	
	Kalk, Robert L.	Pfc.	RA 36924520	
	Marinick, Nicholas L.	Pfc.	RA 12306920	
	Stinnett, Johnnie E.	Pfc.	RA 18214389	
	Thomas, Llewellyn	Pvt.	RA 13253095	
	H, Div Arty	Carr, Harlan	Sgt.	RA 17271012
		Gillispie, Harold	Sgt.	RA 19058791
Mercado, Atanacio		Sgt.	RA 6739348	
Sanders, Elston J.		Sgt.	RA 33176566	
Fitzgerald, Edward		Cpl.	RA 44044182	
Hall, James P.		Cpl.	RA 17013860	
Sandlin, Green R.		Cpl.	RA 39041707	
Drozowski, Edmund		Cpl.	RA 16291978	
Hodge, Marvin R.		Cpl.	RA 34058421	
Kasson, Allen R.		Pfc.	RA 11154559	
38th FA. Bn.	Finney, Thomas B.	Sfc.	RA 34904531	
	Murphy, James H.	Sgt.	RA 39346329	
	O'Neill, Charles P.	Sgt.	RA 6863728	
15th FA. Bn.	Warren, Kenneth A.	Pfc.	RA 18298102	
	Burnsed, William M.	Cpl.	RA 14237211	
	Brursema, Lambert E.	Pfc.	RA 16309585	
	Scott, Neal A.	Pfc.	RA 15357465	

SUBJECT: Monthly Report of Army Aviation Activity

UNIT	NAME	GRADE	ASN
503rd FA. Bn	Gray, Benjamin	Cpl.	RA37448858
	Jackson, Joe	Pfc.	RA 57200425
	Jackson, William	Pfc.	RA 12288721
	Morsaly, Rudolph	Pfc.	RA 14302015
	Denard, Ray A.	Pfc.	RA 16261305
37th FA. Bn.	Scanlan, John P.	Sgt.	RA 15357379
	Memie, Henry J.	Cpl.	RA 35568931
	McKee, Robert J.	Pvt.	RA 17268852

d. Aircraft:

UNIT	NO. AUTH	NO. ASSCD	TYPE	SERIAL NUMBER	MONTHLY TIME
Hq. Co. 2d Inf Div	8	7	L-16B	48-451	47:00
			L-16B	48-455	25:00
			L-16B	48-458	14:00
			L-16A	47-999	28:00
			L-16A	47-996	36:00
			L-16A	47-805	20:00
			L-17B	48-1032	0
Hq. Btry	2	2	L-16A	47-988	72:00
			L-16B	48-456	14:00
15th FA. Bn.	2	2	L-16B	48-441	149:00
38th FA. Bn	2	2	L-16A	47-989	129:00
			L-16A	47-1086	59:00
37th FA. Bn.	2	2	L-16A	47-1085	70:00
			L-16A	47-1083	67:00
503rd FA. Bn.	2	2	L-16A	47-998	47:00
			L-16A	47-1082	62:00
			L-16A	47-1087	62:00

e. Aircraft Grounded:

L-17 48-1032

f. Supply & Maintenance:

Need engine & brake clips for L-16s

g. Flight Information

- (1) Total number of Flights: 220
- (2) Number of passengers flown: 190
- (3) Flyable days during month: 12

h. Remarks:

None

FOR THE COMMANDING GENERAL:

G-4

HEADQUARTERS
2d Infantry Division
APO 248 c/o Postmaster
San Francisco, California

SECRET

G-4 Historical Narrative Report
Period: 8 July - 31 Aug 1950

1. During the period reported, 8 July - 31 August 1950, the G-4 Section of the 2d Infantry Division has had a very noticeable increase in workload due to several factors leading up to the permanent change of station of the organization and eventually its employment in the lines along with other forces of the United Nations in Korea.
2. The actual alert for overseas shipment of the Division was announced on 9 July. Prior to this date, Department of the Army orders were received for the Division to go on the Reduction Table T/O's to include personnel and equipment and this order was in the process of being carried out when the orders for overseas shipment arrived authorizing the reorganization under the N-series T/O's to include equipment listed as "when authorized by the Theater Commander" or "Outside the Continental United States" and also a sixty (60) days supply of expendable supplies.
3. All Technical services of higher Eqs including Dept of the Army, Army Field Forces, Sixth Army and depot representatives from various technical agency depots were immediately sent to Ft Lewis to give the Division every assistance to procure authorized equipment in accordance with T/O's.
4. The prescribed requisition forms were dispensed with and phone calls to depots throughout the United States started the equipment to the Division by the most expeditious means of transportation. This Technical agency assistance was miraculous and within a very short period of time supplies and equipment by the tons were arriving at ports and in the Division Area.
5. The rest technical agencies as well as the Division worked on a 24 hour basis seven days per week and in short order such progress was made that on the 19th July the 9th AFZ sailed with their equipment supplies and personnel practically complete. The 23rd AFZ sailed on 24 July and the 38th on 2 - 3 August. An advance detachment for the division G-4 section consisting of two (2) officers and one (1) enlisted man departed on 21 July with the Assistant Division Commander. On 5 August the remainder of the Division sailed from Tacoma Washington practically complete with equipment.
6. Such small amounts of equipment and supplies which organizations of the division did not receive prior to departure, were placed on requisitions and forwarded to depots for shipment to Seattle port of embarkation thence transshipment overseas to the unit concerned with its assigned shipment number being affixed. This equipment included water trailers, light generators and some other equipment of a like nature.
7. Due to the hastily organized set up at the port of Pusan and without the assistance of a port unit, the advance G-4 representative had insurmountable difficulties in unloading equipment and supplies, however, with at too much loss of equipment, units were sent forward from Pusan port practically complete.

SECRET

The Division closed in Korea on 19 August and was committed as a unit (less 2 battalions) on 24 August.

8. Throughout the period, supplies and equipment were received in an excellent manner with few exceptions. Some of these exceptions are listed below of supplies which are in short supply. ~~SECRET~~

- a. Ammunition, all types
- b. Water trailers
- c. Replacement automatic weapons
- d. Replacement vehicles
- e. Replacement Radios

9. All of the shortages listed have been brought to the attention of higher headquarters for their necessary action. Continual checks are being made and attempts to procure this equipment is being followed.

10. Attached as inclosure 1 are extracts from the daily journal for period 22 thru 31 August.

8 Incls:

1. Extracts from the daily journal
2. Transportation Officers Report
3. Signal Officers Report
4. Chemical Officers Report
5. Ordnance Officers Report
6. Engineer Officers Report
7. Medical Officers Report
8. Quartermaster Officers Report

EXTRACTS FROM DAILY JOURNAL

SECRET

22 August 1950

- 1330 - Lt Col Sinsel, G-4 went forward to new C.P.
- 1600 - 60 additional telephones approved for issue to 9th RCT for use in outpost positions.

23 August 1950

- 1540 - Location of Q.M. installations in Miryong reported.
- 1550 - 8th Army increased basic load of ammunition at ASP to 2 basic loads.

24 August 1950

- 1950 - 702d Ordnance reported maintenance section had moved forward to location some 14 miles from front, contact teams would work out of there. Units notified.

25 August 1950

- 0920 - Division rear C.P. moved forward to new position, west of Miryong.

26 August 1950

- 1150 - Report that I Corps would go into Miryong in near future.
- 1900 - Bani's men were attached to transportation section at Miryong for use as railway guards to and from Pusan with supplies.

27 August 1950

- 1300 - Request for 2 Navy Cubes from 8th Army to use to water down Air Strips, quite dusty, can pick up in Pusan.

28 August 1950

- 1000 - Set up railroad at Chondo for delivery of supplies class I & III to 38th Infantry in North sector.

29 August 1950

- 1100 - Lt General Walker visited Division C.P.

30 August 1950

- 1100 - Units notified A bags of personnel to be stored in units trains areas.

31 August 1950

- 0915 - 8th Army contacted regarding shortage of ammunition. Will get some shipped out today.
- 1040 - 2 DUEWS arrived from 8th Army for special mission, turned over to 9th Infantry.

Incl # 1

Cml Sect

HEADQUARTERS
2d INFANTRY DIVISION
APO 248
San Francisco, Calif.

1 September 1950

HISTORICAL REPORT, DIVISION CHEMICAL SECTION.

1. The Division Chemical Officer was informed on 8 July 1950, that the 2d Infantry Division was alerted for movement to the Far East Command and would depart at earliest possible date at full T/O & E strength. Two days later the decision was made that all outside continental United States (OCUS) T/E items, less impregnated clothing, pertaining to Chemical warfare would accompany divisional units.

2. At time of alert, the Division Chemical Section was one (1) man understrength. This shortage was filled on 18 July, by the return from the Far East pipeline (Ft. Lawton, Seattle Port of Embarkation) of a former member of the section. Personnel of the Division Chemical Section is listed:

GORDON, Richard O.	Lt Col	024 440
KAPP, Rollin W.	1st Lieut	01 037 088
HULIN, Donald F.	M/Sgt	RA 20 943 011
MULLINS, Jasper C.	M/Sgt	RA 6 571 240
GIBBONS, John F.	Sgt	RA 31 483 753
HANSON, Harold M.	Cpl	RA 36 227 435

3. On 11 July authority requested and granted to equip the division with those flame throwers including auxiliary equipment then on hand at Ft. Lewis, Washington. This included both portable and mechanized types together with two types of air compressors. On this date requisition forwarded to the Chemical Supply Officer, Utah General Depot for shortages of OCUS equipment and, in the absence of instructions, a requisition for chemical ammunition submitted also, which was filled by direct shipment to Seattle Port of Embarkation.

4. Each unit of the division departed from Ft. Lewis for the S E P E with full authorized amounts of chemical equipment with the exception of the items listed:

- a. Kit, chemical agent detector, M9A1 (not available at depot)
- b. Kit, agent sampling, M12 (not available at depot)
- c. Apparatus, decontaminating, 3gallon, M1 (shipped by depot to S E P E, 19 July, to travel as division baggage)
- d. Apparatus, decontaminating, 1½ quart, M2 (shipped by depot to S E P E, 19 July, to travel as division baggage)

5. The entire division was equipped to full T/E allowance with the authorized substitute gas mask, M4-10A1-6 (gray rubber), in lieu of the gas mask, M9. Division equipped to full T/E allowance with the authorized dust respirator, M1, in lieu of dust respirator, M4.

Historical Report, Division Chemical Section.

6. Familiarization in the use of the portable flame thrower was conducted by chemical staff personnel during the period 6-14 July. Sixty men per regiment received this training.

SECRET

7. Chemical section personnel departed Ft. Lewis, 1100, 5 August, via commercial chartered bus to S E FE, Tacoma, boarded the USNS General A. W. Greely, AP 141, which sailed at 1500 that day. Arrived PUSAN, Korea, 1645, 19 August. The chemical officer contacted Port authorities 19 August and checked receipt of chemical items. Division Chemical Officer held conference on board ship from 0830 - 1015 August with Capt. E. E. Tiemann, Pusan Logistical Command Chemical Officer. Chemical Section personnel departed PUSAN via rail same day for command post location on the TANJANG River about 4 miles Northeast of MIRYANG. Enlisted personnel accompanied vehicular convoy, 21 August, which transported section impedimenta. Section personnel under the command of the Assistant Division Chemical Officer, attached to 702d Ordnance Maintenance Company, 22 August, to handle chemical logistical support. Company located on East bank of CHONGDO River, about 3 miles North of MIRYANG.

8. Ammunition requirements were submitted to KUSAK on 22 August. Army Supply Point #4, located at Railhead on CHONGDO River at YUCHON, supply point for issue of chemical ammunition.

9. Division Chemical Officer accompanied CP displacement from vicinity MIRYANG closing 0915, 25 August and opening vicinity SONGDONG-NI, 1100, 25 August. Office established with Assistant Division Engineer. Division Chemical Section displaced forward with 702d Ord M Co to vicinity P'CSANG closing 1500, 26 August.

10. On 28 August, section personnel installed one M3-3 mechanized flame thrower in an M443 tank of Tank Company, 36th Infantry. Also furnished 38th Regimental Headquarters with one M1, seven cubic feet per minute air compressor, and performed MWO #9 on six portable flame throwers, 1/3 the current authorized equipment of the regiment. The next day, six additional portable flame throwers modified.

11. On 29 August, Division Chemical Officer reported to higher headquarters a Japanese civil defense type gas mask, recovered by an A Company patrol, 9th Infantry, on 27 August from the East bank of NAKTONG River, about 1500 yards North of and 3000 yards East of the junction of the NAKTONG-NAM Rivers.

12. On 30 August, section installed one M3-3 mechanized flame thrower in an M443 tank of A Company, 72d Tank Battalion, which is to be reallocated to the Tank Company, 9th Infantry. Six (6) portable flame throwers modified for the 9th Infantry. On 31 August, section conducted one day of portable flame thrower instruction for one officer and six men of H & S Company, 2d Engineer Combat Battalion.

13. No problems of especial interest have yet been encountered and insufficient time has elapsed to learn any significant lessons.

Richard O. Gordon.

RICHARD O. GORDON
Lt Col Cml C

Div Cml O

SECRET

Engr Sect

HEADQUARTERS
2d Infantry Division
APO 248
San Francisco, Calif.

SECRET

Historical Report Division Engineer Section

1. On 8 July 1950, the Division Engineer was advised that the 2d Infantry Division was thereby being alerted for movement to the Far East Command. The Division was ordered to move with full TO/E strength in men and equipment. It was also determined that units would be equipped with OCUS T/E items.

2. The Division Engineer Section, upon being alerted, did not have assigned an Assistant Division Engineer. The Section was filled to full TO/E on 20 July 1950. The personnel assigned to the Division Engineer Section were as follows:

Mc Eachern, Joe A.	Lt Col	0-39907
Bell, Robert A.	Major	0-392802
Stewart, Richard H.	SFC	RA-6576247
Killam, Hugh C.	Corp	RA-39946392
Holtzclaw, John H.	PFC	RA-18355946

3. Upon alert of all units of the 2d Infantry Division, the Division Engineer Supply began a check survey including each unit of the Division to cover shortages in engineer equipment.

4. As a whole, the 2d Infantry Division units were found to be about 95 per cent complete on TO/E engineer items of equipment and their component parts. The major items which required attention were:

Sniperscopes
Lensatic compasses
Expendables for sets
Electric lighting sets
Navigation equipment set

5. Special attention was given to the questioning of spare parts for engineer equipment and additional equipment authorized by OCUS.

6. Representatives from the Office, Chief of Engineers, Washington, D. C. visited Fort Lewis, Wash. during the dates 12-15 July 1950 and assisted in expediting shipments of critical items from the Engineer Depots to Fort Lewis, Wash.

7. The units of the 2d Infantry Division departed from Fort Lewis for the Port of Embarkation with full authorized amounts of engineer equipment. Units had items with them or arrangement had been made for delivery at POE.

8. The Infantry units of the Division were given familiarization training and instruction in maintenance and care of sniperscopes.

9. The Division Engineer departed from Fort Lewis, Wash. as part of the party accompanying the Commanding General. The party left Fort Lewis at 29 0600 July 1950 and traveled by commercial aircraft to Tokyo, arriving there 2 Aug 1950. Travel from Tokyo to Korea was by Military Aircraft, arriving in Korea 5 Aug '50. The remainder of the Division Engineer Section personnel departed Fort Lewis, Wash at 1100, 5 August 1950 via chartered bus to Tacoma, Wash., boarded USNS General A. W. Greeley, AP 141, sailing at 5 1500 August 1950. Arrived Pusan, Korea, 19 1645 August 1950. Division Engineer Section personnel departed Pusan via vehicle, 21 0700 August 1950 for Miryang.

10. Division Engineer moved with CP displacement forward from Miryang, closing, 0915 25 August and opening in vicinity Songdong-Ni, 1100 25 August.

11. Division Engineer Supply Dump was established at Miryang Railhead on 26 August 1950. Detail with one officer was assigned to collect engineer material and equipment received on various vessels and consigned to the 2d Division.

12. All water points were placed in operation immediately after arrival and have remained in operation since that time.

13. The first engineer shortage report for losses incurred in combat was submitted to Busak on 1 Sept 1950.

14. To date, no significant lessons have been learned nor have any problems of special interest been encountered.

J. A. McEachern
J. A. McEACHERN
Lt. Col. CE
Div Engr

Ord Sect

HEADQUARTERS
2D INFANTRY DIVISION
DIVISION ORDNANCE OFFICE
APO 248

~~SECRET~~

CSHIS-5
7 Sep 1950

COMMAND AND UNIT HISTORICAL REPORT
(CSHIS-5)

Period of Report - 8 July 1950 - 31 Aug 1950

1. Unit - Special Staff - Ordnance Section.
2. Mission - The mission of the Ordnance Special Staff Section, 2d Infantry Division is as follows:
 - a. Advise and make recommendations to the Commanding General and Staff on all matters as pertains Ordnance, both Technical and tactical.
 - b. Preparation and execution of Ordnance Plans.
 - c. Supervise Ordnance Field Maintenance activities.
 - d. Provide information on the characteristics, capabilities, and limitations of Ordnance equipment, and ordnance ammunition.
 - e. Determine requirements, initiate procurement action, and supervise the distribution and storage of ordnance general supplies and ordnance ammunition.
 - f. Investigate and make recommendations, on instances of improper supply economy and any abuse of Ordnance equipment or Ordnance ammunition.
 - g. Investigate and make recommendations on mechanical and safety engineering matters as affects ordnance equipment and Ordnance ammunition.
3. Operational Statistical Data.
 - a. No organizational changes within Special Staff Section during period.
 - b. Report on Ordnance equipment prior to departure (See Incl 1)
 - c. Summary of activities (See Incl 2)
 - d. Roster of Officers, duties (See Incl 3)

COMMAND AND UNIT HISTORICAL REPORT (Cont'd)

4. Principal problems encountered.

No major problems encountered over and above what could normally be expected under an operation of this type.

5. Miscellaneous:

a. Upon arrival in the theatre of operations it became immediately evident that the organic Division Ordnance company must be prepared to locate within a very few miles of the front line, due to scarcity of roads and the narrow, winding nature of those that are in existence, otherwise the maintenance facilities would be of little value to the units. This operational policy necessitates the taking of the calculated risk of being over-run by the enemy and renders mobility of the company of prime importance.

b. The use of contact parties and properly organized collecting points in the extreme forward areas is of increasing importance in this type of area, in order to minimize evacuation to field shops. Also, due to extremely poor road net and conditions, the service and evacuation sections must be augmented from other parts of the company.

c. In the initial stages, probably for a period of several months, the Division Ordnance unit must be prepared to depend heavily for supply upon its own organic load and on salvage and battle-field recovery. During the first few weeks of the operation, receipts of parts from normal Depot support averages only 11% of requests. It is obvious that in planning an operation of indefinite length, the Supply section of the company must exercise a great deal of ingenuity in determining requirements in the field, and must carry with them as large a supply of repair parts and replacement items and assemblies as the organic transportation will carry, being careful not to waste space with unnecessary or slow moving supplies.

d. The new, simplified ammunition supply system is a great improvement over the old system of allocations and credits. However, in placing full responsibility for determination of requirements and economy of expenditures upon the Unit Commanders, the proper realization by commanders of the problems of ammunition supply, as well as a full understanding of the correct use of unit trains, becomes absolutely mandatory. The adequacy of the authorized basic load, coupled with the lack of any control over issues as long as stocks hold out, tends to "spoil" the units and permit them to develop habits of indiscriminate shooting of ammunition, which in turn results in overloading the Supply pipelines and in unnecessary shortages.

JACK L. GROBB
Lt Col, Ord Dept
Div Ord Officer

3 Incls

1. Ordnance Replacement
2. Daily Journal of activities
3. Roster of Officers and Duty Assignment

HEADQUARTERS
2D INFANTRY DIVISION
DIVISION ORDNANCE OFFICE
APO 248

SECRET
ORDNANCE REPLACEMENT

Initially the Division required approximately 20% replacement of vehicular major items and 15% of small arms and crew served weapons due to unserviceability and insufficient time and/or parts to complete repairs, in addition to considerable shortages of TO&E allowance. Shortages and replacements were, in so far as possible, effected by direct exchange with Mount Rainier Ordnance Depot and by transfer of critical items from other local units. The following items were unavailable from local sources:

a. 3.5mm Rocket Launchers full TO&E was shipped into Fort Lewis by the Chief of Ordnance in time for issue to all units.

b. 250 Gal. water trailers. This item is unavailable nationally. All units will be short approximately 50% of one item. They have been advised to draw a quantity of extra 5 Gal. water cans to alleviate this shortage.

c. 57mm recoilles rifles. 24 of 81 authorized were available locally. Arrangements were made for transfer of full division allowance from N. G. Units in all Army areas. So far 27 received and issued. The balance of 30 were expected daily.

d. M46 Heavy tanks. None available nationally. All tank companies supplied with M4A3 Medium with 76mm Rifle and one heavy tank battalion supplied with 30 M26 Mediums with 90mm Rifle and 89 M4A3 Mediums.

e. M44 Armored Utility vehicles. None available nationally. All units supplied with full TO&E of M39 Armored Utility Vehicle or M3A4 Armored Half-track as substitutes.

One unit will depart with approximately 80% of organizational allowances of spare parts and tools. Critical shortages are in parts and tools for armored and track vehicles.

One basic load of ammunition for the Division, plus 60 days re-supply was originally directed for concurrent shipment. Upon decision of the Commanding General, one basic load was diverted for delivery direct to Ft. Lewis for issue to units prior to departure. The 9th RCT was issued full Basic Load, with exception of 76mm and 3.5 inch rockets from existing Post stocks. It is expected that shipments will arrive in time to Supply the 23d RCT and the balance of the units. To insure this, 160 tons are being transferred from the stocks at Yakima Firing Center by commercial van for arrival tonight. The ammunition not received prior to departure of any unit will be shipped by subsequent shipment for issue at destination. 3.5 inch rocket ammunition which is extremely critical, is being shipped by air to destination.

SECRET

ORDNANCE REPLACEMENT (Cont'd)

In order to have the Division equipped with a single type liaison aircraft, six L-16's were procured from Fort MacArthur and Portland to replace the L-17's, helicopters and unserviceable L-16's.

Barring unforeseen developments, the Division as a whole will move with 100% TO&E ordnance equipment or with satisfactory substitutes. All equipment will be in operating condition although in some cases not considered serviceable by combat serviceability standards.

Success of the move from the ordnance viewpoint in large part may be attributed to the complete cooperation of the Commanding Officer, Mount Rainier Ordnance Depot, Colonel Ray O. Welch. In this undertaking, he virtually opened the door of his Depot to the Commanding General, 2d Division and ignored all routine supply and maintenance procedures in order to get the job done in time to meet the shipping deadline.

HEADQUARTERS
2D INFANTRY DIVISION
DIVISION ORDNANCE OFFICE
APO 248

SECRET

DAILY JOURNAL OF ACTIVITIES

- 8 July 1950. Alerted for Overseas Movement to Far East Command.
- 9 July to
2 Aug 1950.
- a. During this period all ordnance personnel were utilized in the supply, maintenance and equipping of alerted units with ordnance materiel preparatory to movement. This operation was broken down into 3 major phases based on alert priority, i.e., 9th RCT, 23d RCT 38th RCT.
 - b. Teams consisting of maintenance and supply personnel were dispatched to priority alert unit. These teams inspected all types of ordnance materiel for serviceability and completeness, repairing such items as possible on the spot and evacuating other to Post Ordnance shops and MROD. When an item could not be repaired within the limited time or where shortages occurred in TO&E a replacement was immediately accomplished. See Incl 1 for Statistical Report.
 - c. One basic load ammunition issued to units prior to departure.
 - d. With the exception of a few items short nationally, the division moved 100% TO&E.
- 3 Aug 1950 Departed Ft. Lewis 1500. Loaded aboard USS Mitchell at Tacoma Port of Embarkation.
- 4 Aug to 14
Aug 1950 At sea.
- 15 Aug 1950 Docked Pusan, Korea
- 16 Aug 1950
- a. Debarked 0800, moved troops and equipment to vehicle assembly area.
 - b. Advanced party moved out of Pusan at 1530 to establish Ordnance area at Samnang-Jin, contacted Ivanhoe rear.
- 17 Aug 1950
- a. 703d Ordnance company departed Pusan 0730 in serials of 25 vehicles for Samnang-Jin.
 - b. Established ordnance support Samnang-Jin (1180.2-1380.1)

Incl 2

DAILY JOURNAL OF ACTIVITIES (Cont'd)

- 18 Aug 1950. Normal ordnance operation. Established contact with 34th Ordnance Depot Company for resupply.
- 19 Aug 1950. a. contact with Ivanhoe Forward Miryang.
- b. Advanced party of 702d Ordnance Company, consisting of 1st Maintenance Platoon, and a section of supply established ordnance support approximately 8 miles north of Miryang (1170.4-1390.3)
- 20 Aug 1950. Balance of 702d Ordnance Company moved to Miryang.
- 21 Aug 1950. DAO established at Yuchon, approximately 10 miles north of Miryang (1170.4-1390.3)
- 22-24 Aug 1950 Normal operations.
- 25 Aug 1950. a. Advanced party consisting of 1 Maintenance Platoon and sections of supply departed Miryang 0830 to establish new location at Muan-ni (1160.4-1330.6)
- b. Established new location and contact with Ivanhoe Forward.
- 26 Aug 1950. a. Remainder of 702d Ordnance Company moved to new location at Muan-ni.
- b. Contact parties consisting of Maintenance personnel with small supply of spare parts dispatch to Divisional units. The primary objective of these contact parties is to repair such ordnance materiel as possible at the unit location and to aid the various units in any manner possible pertaining to Ordnance equipment.
- 27-31 Aug 1950. a. Normal Ordnance field operation.
- b. During this period approximately 6 trucks were dispatched to 30th and 192d Ordnance at Pusan for supplies.
- c. Very few supplies obtained thru 34th Ordnance to date.

HEADQUARTERS
2D INFANTRY DIVISION
DIVISION ORDNANCE OFFICE
APO 248

SECRET

ROSTER OF OFFICERS AND DUTY ASSIGNMENT

1. DIVISION ORDNANCE OFFICER. Lt. Col. Jack L. Grubb.
 - a. Commands Divisional Ordnance Unit.
 - b. Preparation and execution of Ordnance plans.
 - c. Advises Division Commander and Staff on all matters as pertains Ordnance equipment and ordnance ammunition.
 - d. Provides information on the characteristics, capabilities and limitations of ordnance equipment and ordnance ammunition.
 - e. Supervises operation of field maintenance, procurement, storage and distribution of ordnance materiel.
2. ASSISTANT DIVISION ORDNANCE OFFICER. Maj. Leo C. Cunningham.

Assists Division Ordnance Officer in all phases of operation as may be required to enable him to accomplish his mission efficiently.
3. DIVISION MAINTENANCE OFFICER. Capt. Walter G. Jameson.
 - a. Advises Division Ordnance Officer on maintenance policies and problems of ordnance equipment.
 - b. Accumulates and evaluates information and prepares Statistical reports on status of ordnance maintenance.
 - c. Conducts technical inspections of ordnance equipment in the hands of troops and supervises the rehabilitation of such equipment withdrawn from combat areas.
 - d. Prepares plans and policies for ordnance maintenance support.
4. DIVISION SUPPLY OFFICER. Capt. Frank E. Davidson.
 - a. Informs Division Ordnance Officer on supply policies, procedures and problems.
 - b. Supervision of the ordnance general supply situation including the procurement, storage and issue of such supplies.
 - c. Provides information on excessive rates of consumption and suspected infractions of supply economy

563

ROSTER OF OFFICERS AND DUTY ASSIGNMENT (Cont'd)

d. Maintains liaison with Supply Officers of Corps and Army and Supply Officers of back-up Ordnance Depots responsible of the replenishment of stocks.

5. DIVISION AMMUNITION OFFICER. Capt. David M. Carson.

a. Notifies Division Ordnance Officer on policies, procedures and supply problems of ammunition.

b. Exercises Technical supervision and administration of ammunition supply.

c. Approves transportation orders from units and directs them to appropriate supply points.

d. Inspects the basic loads of units to insure availability and serviceability.

e. Maintains liaison with Corps and Army Ammunition Officers responsible for the replenishment of stock.

QM Sect

HISTORICAL REPORT, QUARTERMASTER SECTION
8 JULY 1950 TO 31 AUGUST 1950

SECRET

During the evening of 8 July a meeting was called at Division Headquarters of all Chiefs of the General and Special Staff Sections; at this meeting we were informed by the Commanding General that the 2nd Division was alerted for earliest practical movement to the Far East Theatre, and that we would immediately go on a seven day week work schedule in making preparations for overseas movement.

On 9 July the Division Quartermaster called a meeting of all Company Commanders, 13th Quartermaster Battalion and 2nd Quartermaster Company, plus the Commanding Officer and S-3 of 13th Quartermaster Battalion, to inform them that the Division had been alerted for overseas shipment. Class II enlisted men and Officers were directed to begin preparation of TO & E check list for use by Division units in checking shortages. This work continued the following day, 10 July, while clothing and inspection teams began inspection of alerted units.

On 11 July Division Quartermaster called Chief Subsistence Branch, CQMG, reference "C" Ration shipment to be issued alerted units. The DQM and an assistant attended a conference with Division G-4 and all unit S-4's with reference to preparation of requisitions for shortages of authorized allowances within the Division.

On the 12th and 13th of July action was taken to transfer personnel disqualified for overseas shipment from the Division QM Company, and to prepare DQM records for overseas shipment. QM Supply Section commenced drawing QM supplies for all Division units.

15 July the 1st Truck Platoon, 2nd Quartermaster Company, loaded seventeen (17) 2½ ton trucks, fourteen (14) one ton trailers, one (1) laundry trailer, and one (1) shower unit on the USS Patrick. This unit was attached to the 9th RCT for the movement.

On 18 July six (6) Officers and one hundred eighty-five (185) enlisted men departed Tacoma Port aboard USS Patrick. MAJOR I. L. LUTHI, OMC, reported for assignment as Executive Officer, DQM.

20 July the 3rd Truck Platoon, 2nd Quartermaster Company, loaded fourteen (14) 2½ ton trucks, twelve (12) one ton trailers, one (1) laundry trailer, and one (1) shower unit aboard the Linfield Victory. CAPTAIN JOHN E. SCHEGOLIN returned from TDY for duty as Division Quartermaster Supply Officer.

On 25 July the 2nd Truck Platoon, 2nd Quartermaster Company, loaded for overseas shipment with cargo consisting of one (1) jeep and three (3) 2½ ton trucks.

1 August elements of the 2nd Quartermaster Company arrived at Pusan, Korea. The Company was assigned an area near Pusan Port with the mission of receiving and processing through the Port remaining elements of the 2nd Infantry Division.

SECRET

Historical Report Contd

On 3 August LT COL ARNOLD C. GILLIAM, DQM, departed Port of Tacoma aboard USS Mitchell. 5 August the remainder of 2nd QM personnel departed United States aboard the USS General Collins. This unit was attached to 38th RCT for movement.

In Pusan, Korea LT HARRY E. MC CORMACK with four (4) enlisted men were attached to Service Company, 9th Infantry Regiment to assist in issuing rations. MAJOR I. L. LUTHI, Executive Officer, and CAPTAIN JOHN E. SCHEGOLIN, QMC, QMDSO, with elements of 2nd QM Company arrived in Pusan.

On 6 August instructions were received through MAJOR WEBSTER, G-4 Representative, 2nd Infantry Division that, by 8th Army Directive, levels of Class II and IV QM Supplies shipped for 2nd Infantry Division were to be turned over to Pusan Base QM. Similar action held for Class I "B" and "C-A" Rations except for three (3) days supply to accompany units. EM items of clothing with the exception of the following specified minimum declared excess:

- 2 suits HBT
- 2 pair boots, combat
- 7 pair socks
- 4 pair underwear
- 1 each coat, field, w/liner
- 1 each jacket, field, M-43
- 1 each suit, wet weather

2nd QM Company was given mission of processing excess back into stock.

On 7 August authorized allowance of Quartermaster supplies by order of 8th Army was as follows:

Class I

Rations

- 1 day in kitchen
- 2 days in railhead

"C" Rations

- 1 day in hands of combat troops
- 1 day in unit reserve

NOTE: "C" Rations held in reserve will only be 75% of command.

Class III

- 1 day in unit
- 2 days in railhead

Class IV

- Expendable
- 15 day Division level

Historical Report Contd

On 8 to 13 August the QM continued processing incoming Division personnel and vehicles with QM Company messing as high as fifteen hundred (1,500) personnel.

On 14 August in conference with LT COLONEL ALLEN, Executive Officer, QM, Pusan Base, it was determined that rations and POL would be set aside by Base QM for shipment to 38th Infantry on or about 18 August 1950 via 2nd QM trucks.

14 August CAPTAIN SCHEGOLIN held conference with MAJOR SHIELDS, 8th Army Class II and IV Officer with following results:

1. Overcoats, OD 7, arriving with sixty (60) days maintenance allowance may be reserved for Division only pending decision by COLONEL WOLFE, 8th Army QM.
2. Time lag in receiving QM Class II and IV supplies is approximately four (4) days from time requisition is placed with QM Pusan Base Command. Levels of requisitioning undetermined due to possible combat losses. No back order system will be established at present.
3. Division QMSO prepared requisition for approximately forty-eight (48) tons Class II and IV for a period of 1 to 15 September. Plan to place these supplies in QM Company one ton trailers as mobile reserve. Critical items such as socks, soap, boots will be main supply.

16 August LT COLONEL GILLIAM, DQM, arrived aboard USS Mitchell. LT JOHN W. SLATER and nine (9) EM Class I Section, departed for Miryang to set up Class I railhead.

19 August six (6) enlisted men, 2nd QM Company, disembarked from USS Collins completing movement of 2nd QM Company personnel. On 20, 21, and 22 August ODQM and 2nd QM Company made motor movement to Miryang and began normal Division Quartermaster operation in support of 2nd Division and Army units attached for supplies. In taking up these functions the 24th Division Quartermaster was relieved. 23 to 31 August normal operations were carried on. An average of 18,000 rations issued daily, miscellaneous Class II and IV, and an approximate average of 12,000 gallons of gasoline and miscellaneous oils. Salvage collection point began processing excess clothing contained in Division "B" bags with laundry working full time preparing excess HBT's, socks, and underclothing for return to stock. A total of two hundred thirty (230) Korean civilians, including fifty (50) females for laundry work, were employed in Quartermaster activities.

Sig Sect

HEADQUARTERS
2D INFANTRY DIVISION
APO 248
Office of the Division Signal Officer

SECRET

9 September 1950

SUBJECT: Narrative History

TO : Commanding General
2d Infantry Division
APO 248
ATTN: G-2

1. MISSION:

- a. Provide signal communication for division headquarters to include communication to units operating directly under division headquarters.
- b. Provide photography, signal supply, and field maintenance of division signal equipment.

2. CAPABILITIES:

- a. Staff planning, supervision of communication training and other signal activities.
- b. Wire and radio communication to units directly under division headquarters.
- c. Teletypewriter service
- d. Limited Radio Relay Communication
- e. Messenger and Message Center service for division headquarters.
- f. Signal Supply service and field maintenance of Signal Corps Equipment.
- g. Still and motion picture photography to include processing still pictures.
- h. Providing limited numbers of motion picture and slide projectors.

3. ON 8 July the Signal Section was preparing plans for operation "PIUTO" with representative from the Sixth Army Signal Section. Upon notification on that date that the 2d Division was alerted for early shipment

to FEC, the immediate problem was supply of signal equipment to divisional units. Direct communication was established with the chief signal officer and by 10 July representatives from the Philadelphia Signal Depot and the Sacramento Signal Depot were flown to Ft Lewis for direct liaison between supply services and the 2d Division to bring all units to to TO&E strength.

SECRET

a. Estimates of shortages were submitted to the Chief of Procurement, Office of the Chief Signal Officer and by 12 July supplies started arriving from depot stock. In the meantime Division units submitted shortage lists and turned in all unserviceable property for repairs. The 2d Signal Company, 205th Signal Repair and 6th Army Signal Maintenance Shop at Ft Lewis all assisted in this work. In all, over a thousand pieces of equipment were rehabilitated thru these sources, and returned to units. The majority of repairs were on Radio Sets SCR-536 and SCR-300 and power equipment PE-210. An order of priority established by G-4 enabled Signal Supply to meet the requirements of RCT's as they were set up for shipment. From 15 to 20% of TO&E items of equipment per unit were replaced. Without exception the three RCT's were equipped to 100% expendable supply based on 30 days combat usage tables. A 60 day back up supply of expendables was shipped direct to POE by the Chief Signal Officer for trans shipment to FEC.

b. Supply conclusion - Lack of Signal technicians in the majority of units resulted in repair shop jobs which normally would be handled thru 1st & 2d echelon maintenance. Equipment, which has been in service for along period, is adequate only for training purposes where it receives only periodic use. Before being sent into combat zones where continuous service is expected all signal equipment should be returned to depots for complete service checks and replacement of doubtful or weak parts.

4. PERSONNEL - Due to heavy drains on the Division for overseas replacements, June 8 found the majority of units far understrength on communication specialists. Critical shortages were Radio Operators MOS 0740, Radio Repairman 0648, Carrier Repeaterman 0187, and Cryptographic Specialists 0801 & 0805. Requisitions thru G-1 succeeded in bringing the majority of units up to or near TO&E strength before departure from the states.

5. PUBLICATIONS - Preparation of Signal Operating Instructions presented a problem as the Signal Section was unable to obtain information concerning frequencies, call signs, codes etc before arriving in FEC. This was overcome by making skeleton SOI items which were used as a working basis to prepare an SOI by the advance Signal Officer representative who accompanied the Division advance party. This officer departed from the States on July 20 by plane. On arrival in Korea he completed the SOI, checked on supply procedures and obtained communication policies from EUSAK.

6. SIGNAL TEAMS - Wire, radio and photo teams from the 2d Signal Company were attached and shipped with each of the three Regimental Combat Teams.

Teams and equipment consisted of:

1. Wire Construction Team - 9 Linemen-1 2½ ton wire truck-1 ½ ton C&R

2. Radio team -- 4 operators - 1 3/4 ton truck - 1 Radio Set SCR-608 and 1 Radio Set SCR-193.

3. Photo Team -- 2 Photographers 1 1/4 ton truck.

A special team was made up and attached to the Division Headquarters Commandant for use at the advance CP. This team consisted of:

- 2 Radio operators w/radio sets SCR-193 & 608 mtd in 3/4 ton truck

2. Swbd oprs & installers - 1 swbd TC-12 - 20 EE Telephones

- 2 Message Clerks

7. VOYAGE - The Signal Section and the 2d Signal Company departed from Tacoma, Washington on the USS General William Mitchell at 1645, 3 August 1950 with 11 officers, 2 Warrant Officers and 292 EM. Time aboard ship was spent in orienting new members of the unit in their job assignment, training in individual and crew served weapons and further preparation of SOI Items.

8. KOREA - The General William Mitchell docked at Pusan, Korea at approximately 1300 hours, 16 August 1950. Arrangements were made for convoying 2d Signal vehicles to Miryang, the remainder of the unit to travel by train. The Division Signal Officer, four other officers and 150 EM departed by train from Pusan for Miryang at 1000 hours 16 August. Train component arrived Miryang 0200, 17 August and was transported by truck to a school house 8 miles NE of Miryang, arriving there about 0500 hours 17 August. 5 Officers and 140 EM were left at Pusan to bring 2d Signal Company vehicles and equipment forward. On 18 August plans were made for setting up Division CP in the school house which we occupied. An emergency BD-72 switchboard was installed, wire lines established to Division Artillery and Division units in vicinity and to 24th Division Rear switchboard. 2d Signal vehicles began arriving from Pusan on that date and continued thru the 19th. As more equipment arrived communications in the Division CP were improved. By 19 August a TC-4 switchboard was installed, radio and wire communications established with EUSAK and Message Center and Messenger service established to Division units as they arrived in the assembly area. On 20 August teams were sent to Samejin to set up communication at Division rear. A radio relay circuit with 3 telephone channels was established between rear and Ivanhoe, the Division CP. A TC-4 switchboard was installed and a Message Center established. This installation remained until the Division rear moved to Miryang on 24 August. The Signal Officer and reconnaissance party left for vicinity of the 24th Infantry Division on 20 August to locate a new Division CP. It was decided to occupy the same area as Headquarters 24th Infantry Division. An advance team was sent to Division Advance on 21 August to install a TC-4 switchboard. The advance signal team was sent forward on 22 August to prepare communication facilities at the future command post. Teams consisted of switchboard operating and installation team, two construction teams, Message Center and Messenger teams and two radio teams.

b. By the 24th of August when this Division relieved the 24th Division, communication was established at the new CP 10 miles west of Miryang and the old CP at Miryang was closed on that date. At the same time Division Rear closed out at Samejin and opened in the vicinity of Miryang.

c. The period from the 24th of August to 31 August was spent in improving communications to the Division units. Wire lines to the RCT's were continually being interrupted due to heavy road traffic and it was found that long wire circuits were nearly impossible to maintain. A switching central was put in operation near the town of Yongsan and installation started on an advance CP four miles north of Yongsan on the road to Changyong. A VHF Relay system was installed to the Yongsan switch which proved to be the only reliable means of telephone communications forward. During this period radio circuits were used extensively both to Army and on Division nets, a considerable portion of the time being the only communication available to the regiments.

9. CONCLUSIONS - A summary of the communication problems encountered during the period of activity in Korea follows:

b. Long Wire Lines were impractical to maintain in this area when laid along road routes. As lines average over 20 miles in length field wire circuits are unsatisfactory, without amplifications.

c. Radio Relay circuits were quick to establish and of good quality.

d. FM radio has failed to work over the distance required and has had to be replaced on Major Command Nets by CW radio circuits.

5 Incls:
Div Telephone Directory
Line Route Map 21 Aug
Circuit Diagram 21 Aug - 31 Aug
Traffic Diagram 21 Aug
Radio Nets 21 Aug - 31 Aug

E. F. BERENDT
Lt Col, Sig C
Div Sig Off

SECRET

1944
1945
1946
1947
1948
1949
1950
1951
1952
1953
1954
1955
1956
1957
1958
1959
1960
1961
1962
1963
1964
1965
1966
1967
1968
1969
1970
1971
1972
1973
1974
1975
1976
1977
1978
1979
1980
1981
1982
1983
1984
1985
1986
1987
1988
1989
1990
1991
1992
1993
1994
1995
1996
1997
1998
1999
2000
2001
2002
2003
2004
2005
2006
2007
2008
2009
2010
2011
2012
2013
2014
2015
2016
2017
2018
2019
2020
2021
2022
2023
2024
2025

1944
1945
1946
1947
1948
1949
1950
1951
1952
1953
1954
1955
1956
1957
1958
1959
1960
1961
1962
1963
1964
1965
1966
1967
1968
1969
1970
1971
1972
1973
1974
1975
1976
1977
1978
1979
1980
1981
1982
1983
1984
1985
1986
1987
1988
1989
1990
1991
1992
1993
1994
1995
1996
1997
1998
1999
2000
2001
2002
2003
2004
2005
2006
2007
2008
2009
2010
2011
2012
2013
2014
2015
2016
2017
2018
2019
2020
2021
2022
2023
2024
2025

CONFIDENTIAL

SOI ITR 37-2
Page 2 of 2 pages

DIRECTORY NUMBERS

<u>TITLE</u>	<u>NO.</u>	<u>TITLE</u>	<u>NO.</u>
G-1 or S-1.....	1	Div Arty O.....	22
G-2 or S-2.....	2	Chnl O.....	23
G-3 or S-3.....	3	Ln O.....	24
G-4 or S-4.....	4	Amo J.....	25
C/S or CX O.....	5	Div Sig Sup O.....	26
CG or CO.....	6	Provost Marshal.....	27
RCT CO.....	6A	Radio Station.....	28
A D C.....	10E	Recon O.....	29
AG.....	7	Wire O.....	30
ORD O.....	8	Wire Chief.....	31
IG.....	9	Photo O.....	32
Sig O or Comm O.....	10	Disut Pt(Pub Tp).....	33
Msg Cen.....	11	Hq Condt.....	34
TT(Msg Cen).....	11E	Mtr Pool.....	35
Aides-de-Camp.....	13	Hq Co.....	36
Light Aviation O.....	14	Sp Svc O.....	37
Div Engr.....	15	P I O.....	38
Div Surg.....	16	QM.....	39
JA.....	17	Wire Const O.....	40
Fin O.....	18	Med Det Div Hq.....	41
Chap.....	19	Clr Sta #1.....	42
Postal O.....	20	Clr Sta #2.....	43
Liv Qu.....	21	Clr Sta #3.....	44
Air Strip.....	114		

NOTE - Phones installed for assistants to the staff officers will be given the number assigned to that section added to 100. Example: Asst to G-4 would be 104.

NOTE - Div Air Strip, regardless of location, is 114.

CONFIDENTIAL

SOI ITR 37-2
Page 2 of 2 pages.

LINE ROUTE MAP OF 2^D INF DIV **SECRET**
AS OF 21 AUG 50

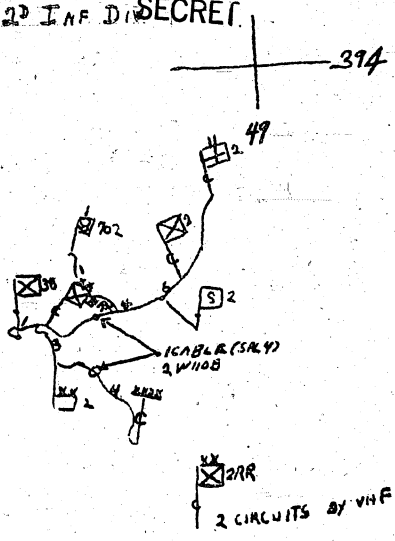

MAP - KOREA 1:250,000 TAEGBU N3500-E12800/100
SCALE

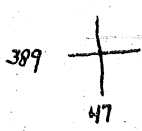

*McLeland
Capt Sig C
Asst W.S.O.*

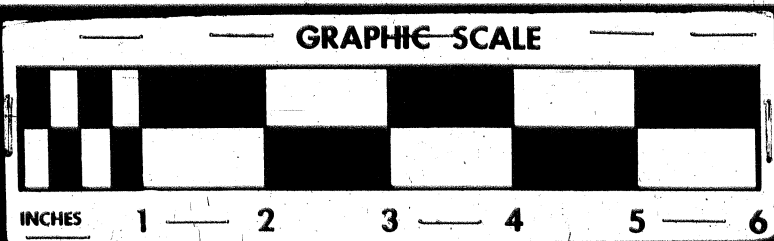

CIRCUIT DIAGRAM 2³ INF DIV
EFFECTIVE 21 AUG 50

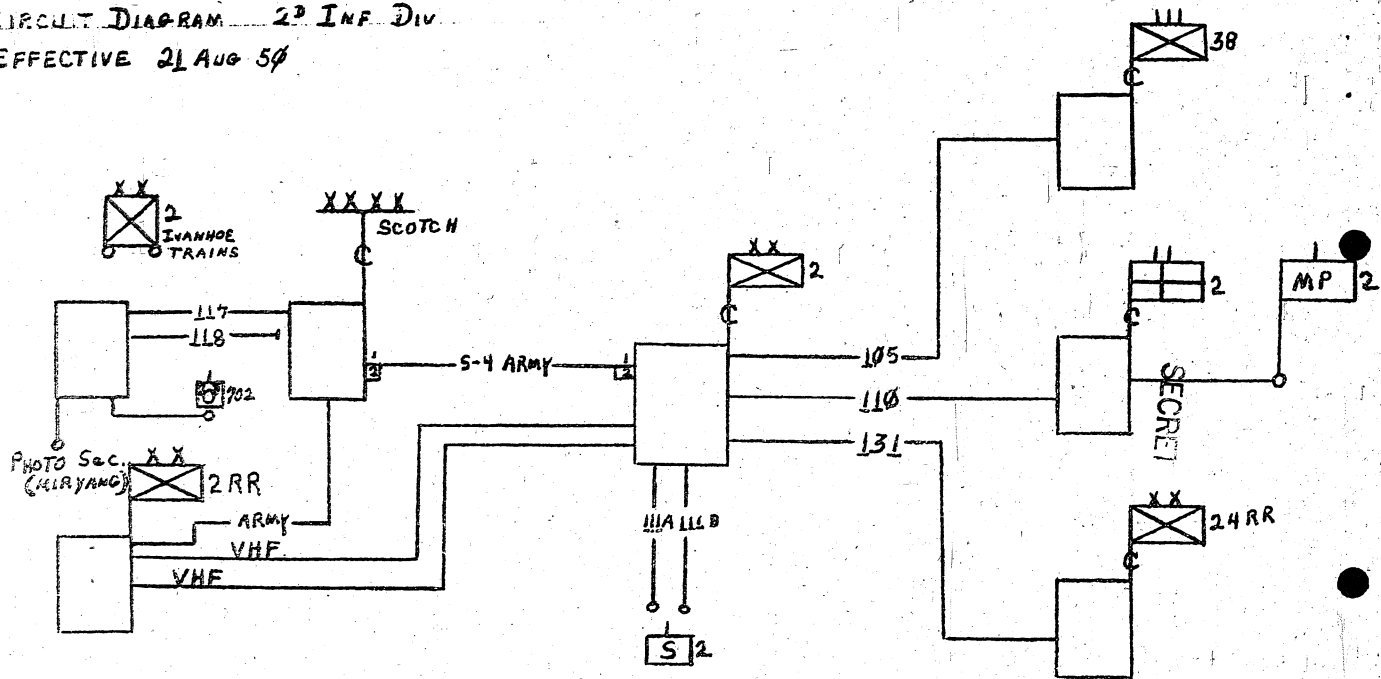

*m. Capeland
Capt USMC*

CONFIDENTIAL

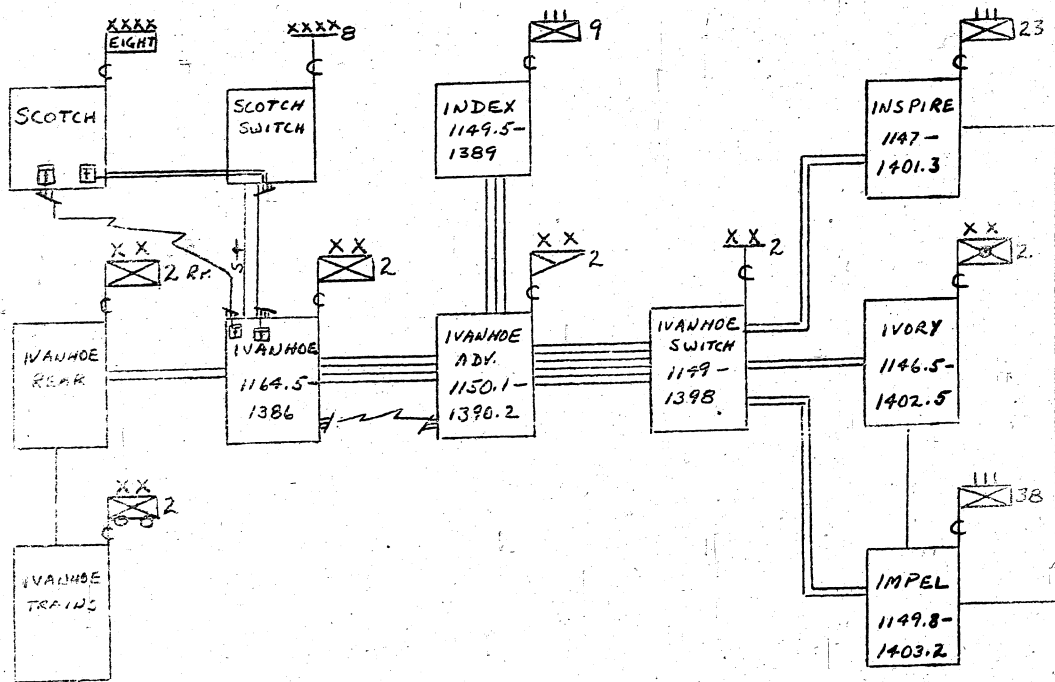

2D INF DIV CIRCUIT DIAGRAM

AS OF 311800 K AUG 50

MAP: KOREA 1:50,000

CONFIDENTIAL

9M [Signature]
[Signature]

SECRET

2D INF DIV

IVANHOE TRAFFIC DIAGRAM

AUG 21-50

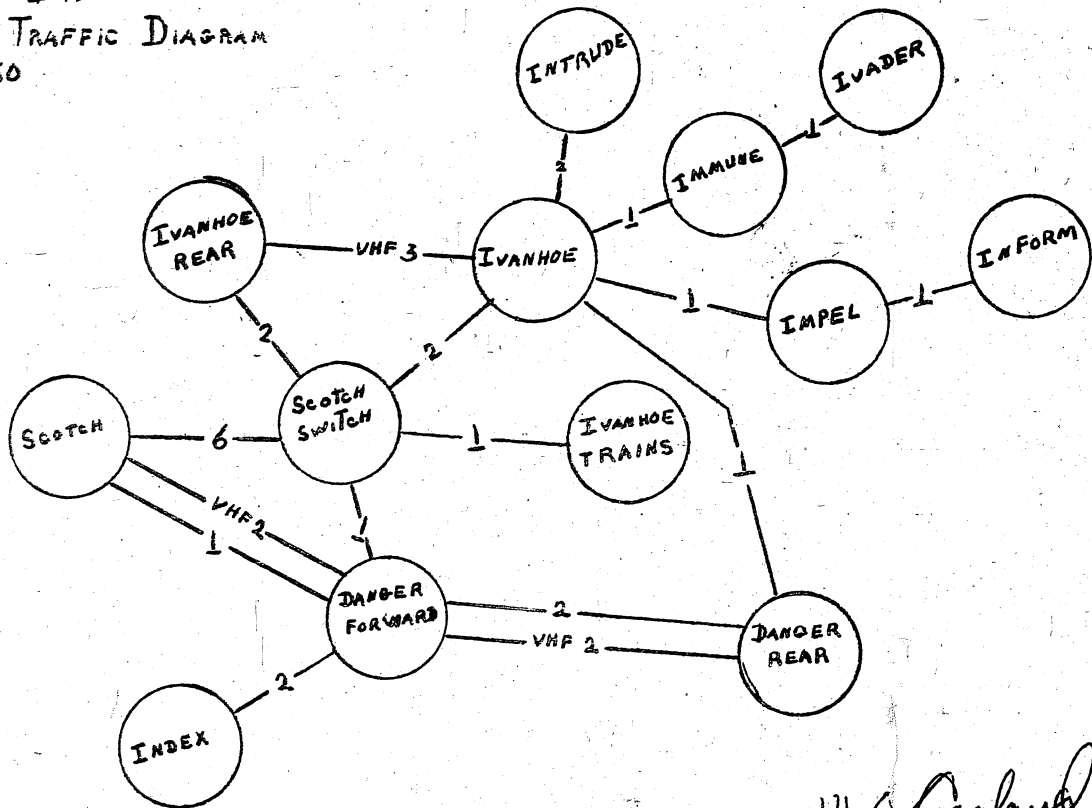

SECRET

*McLeland
Capt Sig C
abt 250*

RADIO NETS AS OF 211500K AUG 50

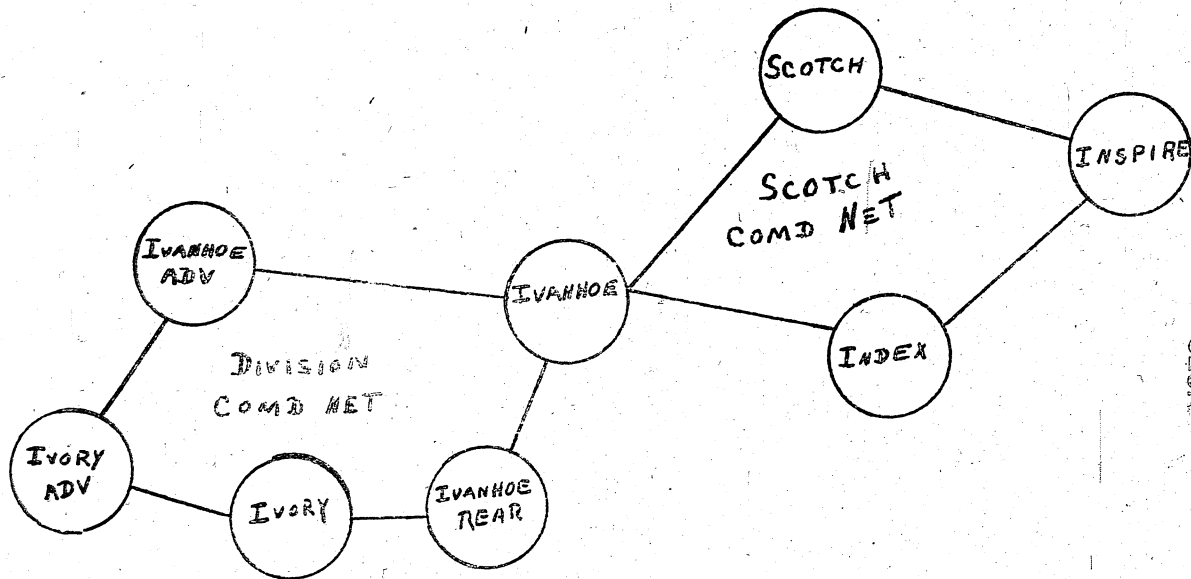

M. Copeland
Capt SigC
asst DSO

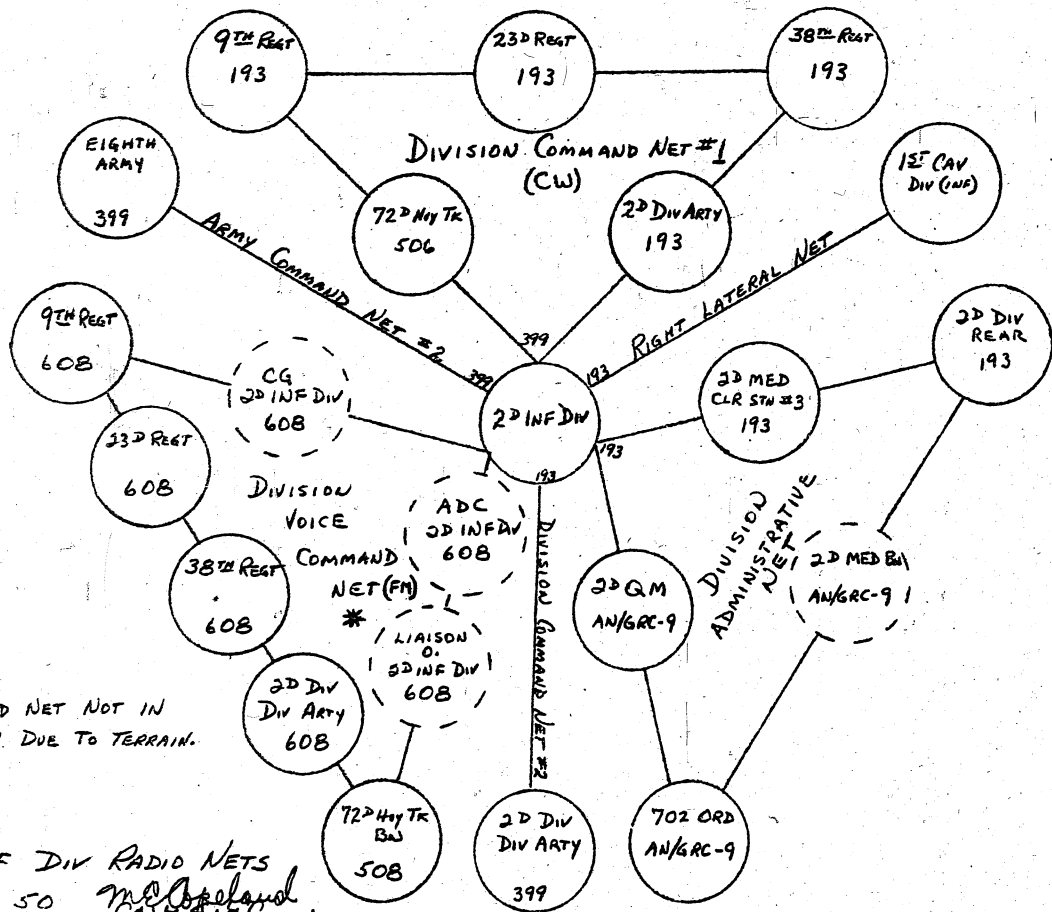

2D INF DIV RADIO NETS
31 AUG 50
M. J. O'Connell
Capt. USAF
SAC, 2D INF DIV

SECRET

Surg Sect

HEADQUARTERS 2D INFANTRY DIVISION
Office of the Surgeon
APO 248

SECRET

6 September 1950

HISTORY

Section I

DIVISION MEDICAL ACTIVITIES

On the 8th of July 1950 at 1900 hrs, the 2d Infantry Division was alerted for shipment to FECCOL. On 9 July, 0800, the Division Surgeon's Staff was alerted. The Staff Conference on 9 July gave the 9th, 23rd, and the 38th Regimental Combat Teams priority for shipment. Immediately the Division was placed on a 7 day week and through this action the Surgeon's Office was covered 24 hours a day. On 14 July, spectacle prescription forms were made and distributed to all Medical units for further distribution to all units they serviced. These forms upon completion were submitted to the Director of Supply, Madigan General Hospital, Tacoma, Washington, who dispatched them by air courier to the Optical Center, St Louis, Missouri. This procedure was utilized in an effort to obtain one (1) additional pair of spectacles for all military personnel having but one (1) pair in their possession prior to shipment. It was recommended by the Surgeon that all troops receive the following immunizations: small pox inoculation within the past 6 months; typhoid, tetanus, cholera and typhus as prescribed by MD Pamphlet 29-11. Requisitions were placed with the Director of Supply, Madigan General Hospital to obtain necessary serum. Units were instructed to complete immunizations, or as far as possible, prior to embarkation. However, adequate serum was placed on each vessel in order that replacements could receive immunizations enroute.

On 12 July, Col Blake, Surgeon's Office, Sixth Army, arrived to assist in the preparation of medical units for overseas shipment. Major Hunt, Surgeon General's Office, arrived on the 14th of July to assist in the procurement of medical supplies. On 17 July, Lt Col Donald E. Carle was assigned as Division Surgeon, relieving Lt Col Mairank who was transferred to 10th Station Hospital. On the 16th of July, troops began departing from the Ports of Olympia and Tacoma. A representative of the Surgeon's Office made a sanitary inspection of each ship and inventoried it prior to its departure for adequate supplies of serum and drugazine. On 19 July, Col Carle departed by air with the Commanding General for FECCOL. The Division Surgeon's Office boarded the "USNAF GREENLET" on 5 August and landed at Pusan, Korea on 19 Aug. 50. Personnel debarked the next day and moved by train to the Division Forward Command Post at Miryang, Korea. The Surgeon's office began functioning immediately, receiving medical reports, locations of medical installations and establishing an SOP to be followed regarding the

SECRET

submission of Medical Department reports by subordinate units. A portion of the Surgeon's Office, consisting of the Sgt Major and 2 clerks, was placed on Detached Service with the 2d Medical Battalion for the purpose of consolidating and submitting the various casualty Statistical reports for the Division. On 25 Aug, the Surgeon's Office departed Miryang and accompanied the 2d Division to their new Forward CP near Khan-Ni. The Medical Annex to the AHC O was prepared on 26 Aug and submitted to G-1, establishing the SOP for evacuation, sanitation, and immunizations. On 29 August, liaison was made with the Eighth Army Surgeon regarding evacuation of patients by helicopter. Three (3) helicopters were based at Pusan and a white helicopter call for emergency evacuation of patients from Clearing Stations. Helicopters were obtained as required and patients were evacuated from Forward Clearing Stations to the 2076th Mobile Army Surgical Hospital at Miryang, Korea.

During this period of the AHC O, 2A HC and 1A HC officers were on duty with the Division. Logees during this period were 2A HC and 2 DC officers.

Status of supplies - PUSAN was established at Miryang with resupply at Pusan. There were no shortages of equipment or material during this period.

MONTH OF JULY*

	7 July	14 July	21 July	28 July
	No. Rate	No. Rate	No. Rate	No. Rate
Battle Casualties				
Non-Battle Cas.				
FUC				
Malaria				
N.P.				
Dengue Fever				
URI	11 25.6	2 4.6		
Gonorrhoea	14 32.6	4 9.9	4 14.6	
Syphilis	1 2.3			
Measles, German				
Meningitis				
Diarrhea, common				
Dysentery, unclass.				
Mycotic Denatosis				
Trench Foot				
Mumps	1 2.3			
Influenza	1 2.3		1 3.6	

*Figures do not include 9 RCT whose reports were made by other organization to which they were attached.

MONTH OF AUGUST**

	4 Aug	11 Aug	18 Aug	25 Aug
	No. Rate	No. Rate	No. Rate	No. Rate
Battle Casualties				12 72.21
Non-Battle Cas.				6 36.10
FUC				83 499.65
Malaria				14 84.28
N.P.				
Dengue Fever				3 18.06
URI				11 66.22
Gonorrhoea		1 23.7	2 47.5	
Syphilis				
Measles, German				1 6.02
Meningitis				1 6.02
Diarrhea, common				15 90.30
Dysentery, unclass.				6 36.10
Mycotic Denatosis				11 66.22
Trench Foot				6 36.10
Mumps				
Influenza				

**Figures do not include 3rd Bn, 9th Inf or the 3rd Bn, 23rd Inf, as their reports were made by other organization to which they were attached.

SECRET

Trans Sect

HEADQUARTERS
2d Infantry Division
APO 248 c/o Postmaster
San Francisco, California

SECRET

Transportation Section Historical Narrative Report
Period: 8 July - 31 Aug 1950

On 8 July the 2d Infantry Division was alerted for an overseas destination.

Immediately a Transport Quartermaster was appointed for the Division under the supervision of the G-4 Transportation Officer.

Under the supervision of the Division Transport Quartermaster a TQM was appointed for each unit whose purpose was to furnish to Division TQM the necessary logistical data as to tonnage, cubage and number of personnel to be shipped. The Div TQM in turn furnished this information to the G-4 Transportation Officer.

The G-4 Transportation Officer was appointed liaison officer with the SEPE for the movement.

Thru the Division Liaison Officer the necessary ships were requested from the Port. The Port notified the Liaison Officer when ships would be available and where they would berth.

The Div TQM then thru the unit TQM called the material to be loaded to the Port. Initially the loading was slow due to lack of Longshoremen gangs to work the ships. However as the loading progressed labor ceased to be a retarding factor and the 11 Cargo Ships were loaded and dispatched in a 19 day period.

Personnel were loaded as personnel carriers became available. A total of 10 personnel carriers were used to lift the entire Division.

Ships were scheduled so the arrival of the cargo ships with unit equipment would arrive at destination prior to or simultaneously with the personnel carrier with the same units' personnel.

Movement of unit equipment was accomplished, to a small marshalling area established at quayside, by unit personnel. Transportation of unit personnel was coordinated between Division and Port Transportation Officers and movement was accomplished by chartered Greyhound Busses. This movement was handled with a minimum amount of confusion and was considered an ideal way to move troops. Some types of commercial means had to be used as unit transportation had departed the home station either to marshalling area or had been loaded on ships. Organizational equipment not loaded on unit transportation was moved by commercial means to the Port of Embarkation.

Upon arrival at Pusan Korea, Transportation was arranged by the G-4 advance party in conjunction with the RTO at Pusan railroad station for dismounted troops.

Vehicles were debarked from ships and a marshalling area at Mileah Race Track, 8 miles from ships side was used for storage and to assemble unit vehicles convoy for movement to predesignated assembly areas.

SECRET

Transportation Section Historical Narrative Report (cont'd)

One officer from the G-4 Transportation Section was left at Pusan to expedite movement of supplies designated for the 2d Inf Div. This officer has proven invaluable in safeguarding and limiting the possibility of supplies going astray.

Upon arrival in the designated combat area an officer of the Transportation Section was assigned to the division Railhead at Miryang. This officer has 10 railway guards. These guards ride our supply trains from Pusan to the railhead. The duties of the railhead officer is to log all receiving and outgoing cars designated for or from the Division. He works closely with the services and advises G-4 of the arrival of supplies.

G-4 Transportation Officer with an Engineer representative made several road reconnaissances and made recommendations for estimates of MSR's.

Transportation of the 2d Infantry Division supported the movement of the 1st Marine Brigade to and from the 2d Infantry Division areas. 50 trucks were used from Division to assist in this movement from railhead to assembly area, thence to assigned combat zone and same amount when the Marines were relieved.

Transportation Officer recommended Chang-do be set up as a holding and re-assignment point for rail cars to relieve the railhead at Miryang which was plugged with supply trains for the 1st Marine Brigade, 24th Infantry Division and 2d Infantry Division. This has been accomplished.

Transportation Officer recommended to Eighth Army Transportation Officer that a coach be added to the daily scheduled hospital trains from Miryang to Pusan and Pusan to Miryang for the use of troops until such time as regularly scheduled trains can be made available to our troops. This would reduce considerably the road traffic. This has been accomplished.

Transportation continued to coordinate all truck movements and in conjunction with the Provost Marshal controls all convoy movements.

AG Sect

HEADQUARTERS
2d Infantry Division
APO 248 c/o Postmaster
San Francisco, California

SECRET
Office of the Adjutant General

HISTORICAL REPORT

3rd Quarter

Jul - Aug -

1. Summary of Activities.

a. The period 1-8 July 1950 was generally routine in nature. On 8 July 1950 the 2nd Infantry Division was alerted for overseas shipment to the Far East Command. From this date until 5 August 1950, this section's primary mission was to bring the Division to T/O strength and otherwise preparing for overseas shipment.

b. Headquarters Fort Lewis was reestablished on 16 July 1950 with Major Harry M. Sebastian, 0491709, AGD, being appointed Post Adjutant.

c. The Adjutant General's Section, less Capt E. C. McLaughlin, who had departed 20 July 1950 by air, and one enlisted man who had departed 18 July 1950 as advance detachment, departed Tacoma, Washington, 5 August 1950 aboard the USN General A. W. Greely and arrived Pusan, Korea 19 August 1950 after an uneventful trip. The section debarked 20 August 1950 and immediately moved to Dammangjin, Korea, where 2nd Infantry Division Headquarters (Rear) was established on the same date. After remaining at this location for one week, Headquarters was moved to Miryang, Korea, on 27 August 1950, where it was reestablished in a schoolhouse on the outskirts of town.

d. On 4 August 1950 a Battle Casualty Section was established under the direction of Capt E. C. McLaughlin, Chief Enlisted Personnel Section. This section was charged with the responsibility of checking and recording, prior to forwarding to Eighth Army, all casualties, battle and non-battle, occurring in the 2nd Infantry Division.

2. Statistical Data:

Number of newly assigned EM processed and assigned by the Classification Section:

July	5429
August	1861
Total	7290

SECRET

Number of newly assigned officers processed by the
Officers Section:

SECRET

July	153
August	28
Total	181

Casualties processed by the Battle Casualty Section
through 31 August 1950:

Battle casualties	861
Non-battle casualties	206
Total	1067

Present attachments to the Division:

2d CIC Detachment
528 MI Service Platoon

3. Peculiar Problems:

The immediate problem faced by this section on receipt of overseas alert was clearing Divisional units of non-POR qualified personnel. Criteria established by original alert was very broad, requiring only that personnel due for discharge or separation prior to 1 November 1950 would not accompany the unit overseas. This personnel was immediately screened and transferred to other non-alerted units on the post. At the same time, POR qualified personnel from these non-alerted units were transferred to Divisional units. On 28 July 1950, notification was received of the passage of the Service Extension Act. This resulted in the transfer back into the Division of the majority of the personnel who had been transferred. 27 July 1950 saw the arrival of the first replacements from other installations within the Zone of Interior. For the next week, the Classification Section, in conjunction with the 2d Repl Co, worked long hours processing and assigning approximately 3544 enlisted men to Divisional units and 1353 to non-Divisional units.

4. Significant Lessons Learned.

None

5. Discussion:

Lessons learned during Exercise Miki in the fall of 1949 proved invaluable in preparing the Division for overseas movement. The AG Miscellaneous Section, under the direction of CWO Fred L. Hornung, III, and in cooperation with Capt Burl V. White, AGD, Liaison officer from the Seattle

Port of Embarkation, supervised the preparation of passenger lists for all units and assisted in the loading of ships. This permitted an immediate fairly accurate count of personnel shipped, thereby aiding the Classification Section in making assignments.

6. Officer personnel assigned during period:

Lt Col Lester W Teter, 051312, AGC, Adjutant General
Maj William H Hill, 0319653, AGC, Asst Adj Gen
Capt Edwin C McLaughlin, 044423, AGC, Enl Pers Sec
Capt John F Regan, 060859, AGC, Miscellaneous Sec
1st Lt Robert W Funderbunk, 02036175, AGC, Postal O
1st Lt James J Maloney, 02025638, AGC, Officer Pers Sec
2d Lt Harold R Murdock, 02210213, AGC, Miscellaneous Sec
CWO Fred L Hornung III, W2115551, USA, Miscellaneous Sec
WOJG William H Martin, RW2141624, USA, Chief Clerk
WOJG Edwin L McGrath, W903515, USA Classification Off
WOJG Raymond E Wenzler, W904003, USA, Miscellaneous Sec



IG Sect

~~CONFIDENTIAL~~

HEADQUARTERS
2d Infantry Division
Office of the Inspector General
APO 248 c/o Postmaster
San Francisco, California

SECRET

3 September 1950

SUBJECT: Historical Report

TO: G-2 Section
Hq 2d Inf Div
ATTN: Historian

On 9 July 1950 the 2d Infantry Division was alerted for possible overseas movement. This found the Inspector General's Office busy conducting POM inspection of the 3d Battalion, 4th RCT.

Reassignments within the section were necessary. On 16 July 1950 Maj or Herman C. Du Vall, then Assistant Division and Post Inspector, was appointed Division Inspector General.

The Inspector General's Office remained open seven days a week handling a number of complaints and keeping a representative of the Inspector General's Office on the processing line for replacements which had been assigned to the Division from various Army Headquarters, Reserve Officer's Training camp, National Guard Instructors, Recruiting Service and many other civilian component assignments. Many of the men were shipped to Fort Lewis on short notice and many unqualified men were weeded out during this processing before assignments were made to the many units which were understrength at this time.

Beginning with the first ships to arrive in the Ports of Tacoma, Olympia and Seattle, Washington numerous inspections were made by the Inspector General and his assistant Capt Wesley C. Owen of Troop Ships and loading of Troops and Troops supplies.

All troop trains arriving at Fort Lewis were met by the Inspector General or his representative, and trains were

~~CONFIDENTIAL~~

SECRET

CONFIDENTIAL

SUBJECT: Historical Report

inspected and troops were spot checked.

Records of investigations and inspections, which were not to be shipped with the Division, were screened and boxed and turned over to Post publications for disposition.

All TO&E equipment issued to the Division Inspector General's Section was inspected, packed and marked according to Regulations.

All buildings, barracks, motor pools and areas vacated by Troops of the Division were inspected and corrective action taken where necessary.

Final preparation for overseas movement of the Sections Personnel and Equipment was completed on 27 July 1950.

From 28 July to 4 August 1950 the Division Inspector General and his assistant continued inspections and investigations and assisted the Post Inspector General in setting up the Post Files and preparations for the large number of troops expected at Fort Lewis in the near future.

On 5 August 1950 Officers and EM of the Inspector General's Office were embarked aboard the USNS General A. W. Greely in the Port of Tacoma, Washington. On 19 August 1950 the USNS General A. W. Greely docked at Pusan, Korea and on 20 August 1950 Officers, EM and Equipment were unloaded and moved by rail and truck to Samnangjin, Korea.

The Inspector General was appointed Security Officer in addition to his other duties. Guard and Security measures were set up for the Camp and maintained 24 hours a day.

On 27 August 1950 the Division CP (Rear) was moved by truck to Miryang, Korea. Guard and Security measures were immediately set up and personnel formed into a Task Force with a patrol and Reserve platoon ready to function if necessary.

On 29 August 1950 the Inspector General proceeded to Taegu, Korea where the 8th Army Inspector General was contacted. Plans for future operations were discussed and outlined.

On 30 and 31 August 1950 instructions in Security, Task Force Mission, Patrolling, and instructions in Crew-Served weapons, and individual arms was conducted.

CONFIDENTIAL

HERMAN C. DU VALL
Major IGD
Inspector General

SECRET

PI Sect

Public Information Section
Headquarters 2nd Infantry Division
APO 248, c/o postmaster
San Francisco, California

SECRET

10 September 1950

SUBJECT : Command Historical Report (Reports Control Symbol GSHIS-5)

TO : Assistant to Chief of Staff, G-2
Attention: Historian

1. Reference Staff Memorandum No. 9, Hq. 2nd Infantry Division, dated 29 August 1950.
2. In compliance with cited reference, Historical Report for the period ending 31 August is enclosed.

1 enclosure

Clifford R. Buckree
CLIFFORD R. BUCKREE
Major Infantry
Public Information Officer

SECRET

Historical Report
1 Aug - 31 Aug, 1950

I. Mission

a. Regular Mission.

(1) The primary mission of a Public Information Office under combat conditions is to publicize the activities and achievements of the personnel in the Division. In the performance of this mission, it also furnishes a tie between the men and their dependents and attempts to enhance the prestige of the National Military Establishment thru factual and objective reporting.

(2) The primary mission is accomplished by the following means:-

- (a) Preparation and mailing direct to newspapers or press wire services of newsworthy actions of the Division personnel.
- (b) Give assistance to civilian correspondents and photographers of the United Nations to include briefings of tactical situation, transportation, housing, feeding and personal equipment.
- (c) Coordination with Signal Corps photographers from the Division or higher echelon to insure visual coverage of both the tactical and administrative personnel.
- (d) To furnish assistance upon call to representatives of Armed Forces Radio Service and other military services in their efforts to secure on-the-spot recordings of Division activities.

bx

b. Additional Missions.

The Public Information Office of this Division has been directed to assume the following additional duties:-

- (1) Publication of the daily Division newspaper.
- (2) Supervision of the Liaison Section, a non-T/O organization formed to house and administratively control liaison officers sent to Division Command Post from subordinate units.

II. Changes in organization during the report period.

a. The section departed from home station with its T/O authorization of two officers and eight enlisted men.

b. Upon arrival in Korea, it was augmented by one (1) officer and two (2) enlisted men from the TIE section with the instruction that this personnel would assist in the operation of the Liaison Section.

III. Summary of Activities.

a. Shipboard.

Approximately one-half of the reporting period was spent on shipboard enroute to Korea. During this time the personnel prepared a daily issue of the Division paper, collected and edited news for a daily broadcast over the ship's public address system. Without knowledge of the theater policy relative to hometown releases, no actual mailings were made but notes were

SECRET

taken on ship-board happenings for further dispatch.

b. In Korea.

Initially, the office was established at the Division Advance Command Post at Miryang. All personnel concentrated on home-town releases and a total of approximately 440 were mailed to 31 August 50. In addition to our own efforts, men of the Division mailed home copies of our Division newspaper containing personal anecdotes of themselves or friends.

On 22 August the first war correspondent checked in to the command Post and stayed with us throughout the reporting period. On the same day, Pfc. Leonard W. Turner, RA21201624, Stars and Stripes representative from TIE section, GHQ, reported. Both these representatives were furnished short histories of the Division and some of its units, together with biographies of our General Officers.

On 25 August, the advance command post was moved forward and the following breakdown of personnel made:-

- (1) One man each to our three regimental combat teams.
- (2) One man to Division Artillery.
- (3) One man to handle special units (M. P., Med., Engineers, Ord., etc.)
- (4) One man retained at the CP for special assignments.
- (5) One man retained at the CP for clerical and housekeeping duties, including typing of hometown releases sent from front-line correspondents, special features, etc.
- (6) One man retained at the CP as Managing Editor of the Division newspaper.
- (7) The PIO and Assistant PIO remained at the CP.

In connection with assignment of our personnel to units, they were under instructions to report on the men who fight the war and not attempt to cover large-scale activities which is in the province of civilian correspondents.

A total of twenty one civilian correspondents, representing the major world news services and large daily papers worked in the Division area during the week 25 August to 31 August. In addition to the above, coverage was obtained by representatives of Stars and Stripes, Armed Forces Radio Service, and photographers from Eighth Army Headquarters.

Material and pictures were gathered from unit PIO personnel to assist Stars and Stripes reporter in making a dead-line for a special feature section in that paper to appear early in September. Inasmuch as regular Signal Corps photographers had not been operating, it was necessary to gather pictures from the units. The Division Artillery was particularly helpful giving up personal negatives in some instances and the balance was film they had purchased from unit funds.

IV. Principal problems.

a. Excess In-Grade Personnel

The T/O of an Infantry Division allows only seven grade 4 (Corporals) and one grade 3 (Sergeant).

Upon departure from home station, the section was already over-grade by one Master Sergeant, one Sergeant First Class and two Sergeants.

Basically, the T/O grade distribution is inadequate and it is recommended this be a matter for study by higher authority. Our recommendation is three (3) first graders, four (4) corporals and one (1) PFC. A serious morale problem results when promotions are not possible with resulting re-

SECRET

quests for transfer. The policy of encouraging transfers to front-line units for those desiring promotions might be sound if trained replacements were available in lower grades. Since this is usually not prevalent, an impasse is reached and it requires constant encouragement of the personnel to prevent lazy attitudes.

b. Equipment.

The T/E authorization of one typewriter for the entire section is totally inadequate even in garrison duty. This becomes increasing apparent under field conditions of constant usage, by both PIO personnel and numerous civilian correspondents, and filtering dirt which defies all efforts of maintenance. ^{every} ^{vector dev}

The ~~record~~ ^{recorder} and power unit is heavy and cumbersome and should be replaced by a small tape-recorder.

The authorized transportation of one (1) one-quarter ton with trailer proved totally inadequate to carry T/E authorization plus small supply of stationery and miscellaneous supplies. Mimeograph paper for the Division newspaper was delivered to us but no transportation was available to carry it to new location. Shuttling by Headquarters Company vehicles, if available, was the only solution. Later, when this section was assigned responsibility of the Liasen Section, we received an additional 3/4 ton carrier and one-ton trailer to assist in carrying its squad tent, extra bedding, CP tent, mapboards, etc.

c. Publication of the Division Newspaper

As indicated above, the Warrior was being published at the Advance CP in ~~one of~~ ^{one of} the tents allocated to the section. The resulting over-crowding from PIO personnel, correspondents, etc., and the impossibility of carrying supplies necessary for a 3000 daily issue made it imperative that this function be transferred to the rear CP. In addition, this expedited distribution. After a process of trial and error, it was found that the regular mail runs were the best distribution methods. Distribution thru divisional ration breakdown was tried but experience showed that many times the front-line troops did not receive issues until 24 to 36 hours after publication.

d. Civilian Correspondents

The greater number of correspondents carried no sleeping equipment nor were they equipped with helmets or canteens. It is urged that consideration be given to equipment at Army level each civilian correspondent with shelter half, sleeping bag, blanket, helmet, canteen, mess kit and first aid packet as the essential minimum. There is no specific control of numbers of correspondents assigned to a division nor is advance notification received. This condition taxes supply and messing facilities.

e. Photographic Coverage

In spite of maximum cooperation from Divisional Photo Officer, the question of increasing a divisional PIO section to allow four (4) photographers should be studied under field conditions. The primary mission of Signal Corps photographers is combat intelligence and their technical training does not encompass PIO work with its attention to human interest. The greatest difficulty however, is the attempt to form teams of Signal Corps photographers and PIO personnel. In theory, this is very practical, but in operation the effectiveness is minimized due to the inherent differences of missions. A reporter must talk to people and the time involved interferes with the schedule of Signal Corps photographers. Assignment of PIO photographers who could double as reporters would greatly enhance the publicity given to the Division and ultimately result in a benefit to the Department of the Army as a whole

SECRET

As previously mentioned, unit personnel are cooperative in giving up negatives for PIO purposes. However, in view of the fact the film is personally owned or purchased from unit funds, they rightfully expect return of the negatives. This is contrary to Signal Corps regulations and it is suggested that this be studied so that official Photo Labs make copy negatives for permanent record and allow the original negatives to be returned to the units thru Divisional PIO. The PIO could control the number of films sent forward for processing. It has been found that the unit personnel are skilled photographers - many of them winning prizes in competition - and from a PIO standpoint, their pictures are many times superior in composition and human interest.

f. Policy From Higher Headquarters

Immediately upon arrival in Korea, Division PIO contacted higher authorities by telephone for instructions on processing hometown releases and special features. Initially, instructions were received to process everything thru higher headquarters. With the large number of hometowns written, this did not seem feasible but instructions were issued to follow this policy. The next day, Army PIO called and indicated he had discussed the problem with the Chief of Staff and we were given permission to send everything direct to the United States. In response to our request for written policy guide, we received copy of instructions given to civilian correspondents and told this was the only official guide available. On or about September 3, a policy guide of six paragraphs was received from Hq. EUSAK, and we found that we had generally already adopted its contents although some hometown releases were mailed naming subsidiary units of the Division. This was immediately corrected.

V. Principal Accomplishments

a. Prompt mailing of over 400 hometown releases to offset the lack of publicity relative to the Division's activities. The PIO section was sent on the last boat and no personnel could be spared from units already in combat to cover operations until the staff arrived.

b. In spite of difficulty of supplying personal needs of correspondents, we have received many expressions of thanks from the civilians for our spirit of cooperation and assistance given them in on-the-spot briefings regardless of the hour and the fact that only one or two correspondents were involved. This last point is important to those correspondents who filter into the Division during all times of the night and day and wish to be entertained then or desire to move forward.

c. The majority of the PIO personnel maintained a high interest in their work and accomplished excellent results. Consistent with human nature, two members desired to more actively participate in action by transfer to front-line units in secondary MOS's and efforts to present the importance of their role in reporting on their fellow-GI's were not entirely successful. Due to the excess grades in the section, and resulting impossibility of promotion, immediate requisition was placed for replacement in grades no higher than Corporal and the members who desire more active participation in the war will be transferred as soon as possible.

Enclosures

1. Shipboard issue of Warrior
2. Korean edition of Warrior
3. Hometown release (example)
4. Instructions to Correspondents (Copy)
5. TWX Re: PIO Policy (copy)

SECRET

THE WARRIOR

Vol. 1 No. 6

USNS Gen. A. W. Greely

13 August 1950

AMERICANS HOLD POHANG AIRSTRIP

WORLD AFFAIRS:

LONDON---King George and Queen Elizabeth slipped almost unnoticed into Clarence House through a side door just after dusk to visit their daughter, Princess Elizabeth, who expects another child at any time.

STRASBOURG, France---The European Assembly voted overwhelming approval of a great unified European Army after Winston Churchill had warned that only American Atomic bombs shielded Europe from Communist aggression.

WASHINGTON---President Truman will not ask for Universal Military Training to build up the Armed Services this year although he is "as strong for it as ever", the White House announced.

WASHINGTON---Senator Styles Bridges (Rep N.H.) insisted that Korean war casualties are much higher than the Defense Department has announced but an Army spokesman denied any attempt at deception.

WASHINGTON---Senator Robert A. Taft (Rep) said that Senate legislation giving President Truman all an emergency rationing controls is "statistical" and unnecessary unless the Korean fighting flares into World War III.

WASHINGTON---The Senate Finance Committee voted to boost personal income taxes by 10 to 20 percent beginning October 1 to help finance the Korean war.

WASHINGTON---The House voted contempt citations against General Mayor Philip Bart of the New York Communist Daily Worker and 53 other witnesses who refused to testify on subversive activities.

RETURN PAST DUE library books to the library immediately.

AIR FORCE DIGS IN WITH INFANTRY

SOUTH KOREA---American patrols in half tracks pushed the Communists back two to three miles from the vital Pohang air field while on the southwestern front the 5th Regimental Combat Team pulled up to within three miles of Chinju.

Two American destroyers joined the defense of the Pohang field early Saturday. They stood off shore with their guns ready to add to the firepower of American tanks, infantry and artillery and a crack South Korean unit dug in on a defense perimeter.

Although a Communist spearhead driving on the field spent the night within rifle shot of the airstrip, there was only scattered firing. Eleven Communists were killed during the night and three American Negro infantrymen wounded.

The Communists, between one and one and a half miles away during the night, were unable to interrupt air operations Saturday morning. A fleet of Mustang fighters which left the field Friday night for a safer haven roared back Saturday to help defend it.

Air Force ground crew officers and men joined in the defense of the field. They dug in beside American Negro infantrymen and troops of a crack South Korean unit. American tanks and artillery backed them up.

On the Southern Naktong front 24th Division troops attacked enemy forces estimated at as much as a battalion strength south of the Changyong bridgehead across the Naktong river Saturday.

From the embattled airport at Pohang, Korea, United Press staff correspondent Robert Vermillion reports: Confident American and South Koreans were poised for an all-out battle to keep the North Koreans from capturing (Continued page 3)

The WARRIOR Personal

Published by the Public Information Section, Second Infantry Division, in the interests of the passengers and crew of the USNS Gen. A. W. Greely. Copy for the WARRIOR should be submitted to the ship's library or PIO personnel. Office is on D Deck, Stairwell 5.

CHAPLAIN'S CORNER

Back in the good old U.S.A., soil conservation is a live topic. Owners of farms are being taught to improve their land so that it will produce more. Recently, I saw two pictures of a man standing in a field of alfalfa. In the first picture the crop only reached to his ankles, while in the second the alfalfa was beyond his knees in height. What made the difference in the two?

Simply this: In the first field, nothing had been added to the soil and consequently the crop was starved; in the second field, man and nature had cooperated in adding the needed elements to the soil to nourish the crop.

In the soil of the soul we need to place clean language, prayer, and God's word. Then we must cultivate it with Christian fellowship and plow it deep with Christian service. Then, and then only, will we reap a hundred fold.

MEMORIES

Compartment E-9 will see "Daughter of Resie O'Grady" tonight at 1900 in the Troop Mess, with the overflow being permitted to see the second showing at approximately 2115 hours, along with EM from Compartments E-7 and E-8. Admission by mess card only.

"Ticket To Tomahawk" will be presented in the officers lounge at 2030 hours.

KOREAN LANGUAGE LESSON

English followed by Korean pronunciation:

I'm hungry---SEE-Jahng HAHM-nee-dah
 I'm thirsty---MAWNG mah-ROOM-nee-dah
 I'm lost---NAH-noon KEE-rool eer-huss-SOOM-nee-dah
 I'm wounded---NAH-noon CHAWM-tahch-huss-SOOM-nee-dah

"Another birthday, another boat, another ride" sums up Sgt. Roy L. McCurley's impression of his 33rd birthday on 9 Aug. His 29th birthday was also spent on a transport as he returned to the U.S. following action in the South Pacific with the 4th FA Bn. He is now a member of Casual Co. A. His home town is Spring Lake, N.C.

"Shorty" Payne, 3rd cook in the troop mess, who originally hailed from Los Angeles, Calif., before he took to the seven seas, is being touted as quite a magician by all the men who have pulled KP on board. "Shorty" used to do his stuff in vaudeville.

The scound of the big shells booming won't be anything new for Pfc. Preston Smith, Los Angeles. Smith was an ammo specialist at Aberdeen Proving Grounds, Md., prior to joining the Indianheads.

Sgt. 1cl Zinn Carrigan, Kansas City, came to the 2d Division from the 3rd Division at Ft. Benning. Carrigan has eight years service and "getting ready for my second war." He served with the 245th Ordnance Co. in the Pacific.

Another 3rd Division man now with the Second is Sgt. George Powell, Columbus, Ga. He was with the 92nd in Italy and after hostilities ceased, served in Japan with the occupation troops.

M/Sgt. Ben Thompson, Brockettville Tex., a veteran of 13 years service, served with the 76th Coast Artillery and saw more than 30 months of action in the Pacific.

Pfc. Frederick Howard, Roper, N.C. is still another of the many 3rd Division soldiers aboard. He was with the 549th QM Co. during the last conflict.

A Special Services sergeant was holding forth on one of the Special Services ocarinas when a GI, Pvt. Irving H. Mott, Maine, was heard to remark, "Korean Okie, no doubt."

Pfc. George A. Jordan, San Jose, Calif., lost Friday not once, but twice. One of the Fridays was just as well lost, he explained, since it was Friday 13 February 1948. This is Jordan's second crossing of the Pacific.

SECRET

SENDS MACARONI TO STALIN, MALIK

CROWN PRINCE TAKES OVER BELGIAN THRONE

NEW YORK---An elite macaroni manufacturer dispatched two cases of macaroni to Josef Stalin and Jacob Malik, along with instructions on how to conduct macaroni eating contests.

Emanuel Ronzini, Jr., aroused by Russian radio charges that the United States is a carnival of murder, mayhem and macaroni eating contests, sent his gifts to prove to the Russian leaders that some American pastimes are harmless.

STRIKE THREATS EASE

CHICAGO---A rash of strikes and walkout threats eased in the nation Friday, but mobile pickets who defied State seizure snarled home-bound transit service in St. Louis.

A wildcat strike ended at the vital Oak Ridge, Tenn. atomic project and a threat of a nationwide walkout in the meat packing industry here diminished.

In St. Louis pickets in automobiles drove about the city stopping street cars and buses and persuading operators to join their strike. A threatened walkout of operators ostensibly had been halted by state seizure.

RECRUITS SWORN IN ON "OLD MO"

NEW YORK---The USS Missouri on whose deck the Japanese signed the surrender ending World War II, bore witness to another kind of ceremony.

Sixty recruits from the New York area were given a special swearing in ceremony at which Rear Admiral John Hazard Carson rendered the oath.

WASHINGTON---Secretary of State, Dean Acheson, said that Senate passed legislation sponsored by Senator Pat McCarran (D Nev) to tighten immigration restriction.

WASHINGTON---T. Keith Glennan, President of Case Institute of Technology, Cleveland, O., and former Hollywood studio manager, was nominated by President Truman for a five year term on the Atomic Energy commission.

LOS ANGELES---John Frazier got the last laugh at a judge who became so annoyed at his guffaws that he arrested him.

Another judge awarded Frazier \$4,150 damages.

BRUSSELS, Belgium---Crown Prince Baudouin, shy 19-year-old elder son of King Leopold III, became chief of the Belgian State before a riotous joint session of Parliament.

He scarcely had returned to his palace before he was confronted with his first political crisis. Catholic Premier Jean Duvieusart and his ministers, who were responsible for bringing back Leopold, handed him their resignations.

AIR FORCE DIGS IN WITH INFANTRY

(continued from page 1)
this airfield. Pilots, infantry and tank crews were ready for an assault expected at any moment on this strip, the American's biggest and best in South Korea. The commanders were confident the field could be held. But standing offshore near the coastal airfield were two U.S. destroyers and a fleet of South Korean vessels ready to evacuate as many men as possible if the Communist attack proved overwhelming.

GREELY HAS PROUD RECORD

The USNS Gen. A. W. Greely has a proud record for its last seven months of service.

She has carried more than 100,000 passengers over 53,000 miles, which would twice circle the globe at the equator. She has sailed from New York to Germany and back four times. One voyage without returning to New York carried her over 32,000 miles.

On her first trip of the year, Captain Samuel B. Whedbee was in command. July 11 Captain Gelin, the present Master, relieved Captain Trick who had assumed command on the death of Captain Whedbee.

REDS CONCENTRATE FOR KILL

LAKE SUCCESS---Great Britain told the United Nations Security Council that "the dark forces of Communist imperialism are concentrating for the kill" in Asia and there can be no settlement of the Korean crisis unless the "invading forces in Korea should go back where they came."

LOST: Witnour watch left in latrine. Please return to Pfc. Joseph R. Tantorno, Ship's library.

A MESSAGE FROM YOUR DIVISION COMMANDER

About a week from today we can all expect to be in Korea. We men of the 2d Division have a tough job ahead of us and must take every opportunity on shipboard to perfect ourselves as soldiers. Smart, alert soldiers know this; the lazy ones will put it off until it is too late.

In Korea our mission will be to kill Joe Stalin's mobsters. Make no mistake about it and prepare yourselves mentally and physically for this job.

The 2d Infantry Division will do a thorough job only as a team. We have the men and the weapons to make a superior team but you, as an individual, must play your part. How can you do this? Here are a few ways:

1. First, take care of yourself physically. Eat only American food cooked and prepared according to our standards. Never drink local water until it has been treated. Keep your body clean and also the area which you occupy. Korea is centuries behind the times according to our standards of sanitation. Don't sink back to these standards like a lazy, stupid animal; be smart and you will keep your health.

2. Next, take care of your weapons and equipment and make yourself an expert in their use. You will then have confidence in them when the time comes to use them, and when that time does come they will not let you down. If your weapons are dirty or rusty they may fail mechanically, and such failure at a critical time may cost you your life, and the lives of others.

3. The next thing in importance is to perfect yourself as a member of the team. Just as a baseball team is made up of a pitcher, catcher, infield and outfield, likewise the 2d Division is made up of rifle, machine-gun, mortar and other squads, artillery sections, tank and engineer platoons, companies, battalions and regiments. If each and every one of these teams from the squad to the regiment does not perform like a World Series baseball team, the results are unsatisfactory and a battle may be lost. In war, all of us want to be on the winning team, but in order to win we must all play heads-up ball.

4. The last point which I wish to emphasize is confidence. No unit in the 2d Division will let any other unit down regardless of the size of that unit. So remember that no matter how rough the going may be for any of the hundreds of teams that make up our division, you can have confidence that the other teams are doing their jobs too. And the same goes for the rest of our Army and for our Navy and Air Force.

You and your buddy with your rifle bayonet and grenades are the smallest but most important of all the teams. But it's up to you to be alert, be smart and do your part to make the 2d Division live up to its fighting motto, "Second to None".

TWO COMIN'---THREE A-GOIN'

"Two comin' and three a-go'in'" could be Sgt. 1cl William J. O'Brien's slogan on this cruise, which is, of course, the third a-go'in'.

It was another war and another direction when O'Brien made his first ocean crossing in 1943. After a stormy passage of the North Atlantic aboard the Mauretania, he served with United Kingdom headquarters in London.

The return, on the Queen Mary, was a pleasure cruise in 1945.

He volunteered to take part in the Bikini A-bomb tests and sailed for the sunny Pacific aboard the USS Wharton, Joint Task Force I flagship.

He served as chief clerk of the Army Ground group from the headquarters set up in the Wharton anchored in the lagoon. Twice while he served with the force, the peaceful waters burst into violent action as the fourth and fifth atomic explosions known to man took place.

Sgt. O'Brien returned to the U.S. in September of 1946 on the aircraft carrier Saldor. Following his return Statesides he served in the Pentagon and at Fort Meyer as a clerk in the Military District of Washington headquarters.

Originally from Oshkosh, Wisc., Sgt. O'Brien has been in the Army for ten years.

South Korea is estimated to be populated by about 19,370,000 people.

SECRET

CHOW CONSUMED 'IMPRESSIVE'

The average of 1920 troops who pass through the chow line each meal manage to stow away an impressive amount of chow, seasick or not, according to Bob Johnson, cook in charge of the Army galley.

For example, each breakfast finds the men putting away a grand total of 4,680 eggs. This morning's menu, which featured Spanish omelet, used that many eggs, plus two cases of green peppers, two cases of celery, 50 pounds of onions, and 80 pounds of tomatoes.

At least 500 loaves of bread are baked each night, with the total rising to 650 loaves upon occasion. Four ship's bakers and four GI bakers work the two shifts, with the night crew coming on at 1700 and baking most of the bread. The day crew turns out the pastries. Six electric ovens turn the bakery into a hot box as each oven turns out four pans of 5-loaf sets at a time.

Six Deisel oil fired stoves and an impressive battery of steam cookers turn out the food for the troop mess. Three ship's cooks and a half dozen "good GI volunteer cooks," to quote Johnson, work the day shift while two civilian cooks and about six GIs work the night watch.

Troops pour 150 gallons of soup down the hatch each meal that it is served, topping it off with 200 gallons of coffee. Between 400 and 500 pounds of meat are consumed each meal, while more than 1,500 pounds of potatoes have been put away by hungry men each day.

Mr. Lawrence Alfonsin, 3rd steward, who is in charge of the troop mess, uses 67 Eps a day, while other parts of the kitchen system (bakery, butcher shop, and the officer and troop galleys) use another 58 men.

Watching the preparation of a meal emphasizes the international character of this "excursion" perhaps more than anything else. The flour is from Minneapolis, meat from Chicago, condensed milk from New Jersey, ice cream from Long Island, N.Y., sugar from Cuba, and the cocoa used Saturday night was from Bournville, England.

Mr. Thomas Hodge, chief steward of the Grecly, has over-all supervision of food service aboard ship. The problem of supply and issue, and making the master menu for all meals, is his responsibility.

Cpl. Willie Olivares, Aransas Pass, Tex., wanted to insert a "Lost" item. "Lost. Six bucks in a dice game."

DEAD MAN WALKING DECKS

There's a dead man walking around aboard this ship.

He was killed in Europe in December of 1944. The War Department said he was dead, and his family collected his National Service Life Insurance.

The whole thing came about because two men in the same regiment bore the same name, and there was only a one digit difference in their serial numbers.

William R. Fitzpatrick, now a first lieutenant in the division G-3 section, served through the war with the 35th Infantry Regiment, 90th Division.

On a beach in Florida, while the division was in training, he found a pair of dogtags in the sand. He was wearing his own but here were their twins. All of the information—name, religion, blood type—was identical to his own. But close examination showed this difference: his serial number ended with 91. The other William Fitzpatrick's number ended with 81.

He returned them to the owner, also a member of the 358th.

Months later, after the division had landed in Normandy and fought its way into Northern France, the other William Fitzpatrick was killed.

Back in New Mexico, Lt. Fitzpatrick's family were duly notified of the death of their son. One of his dog tags was forwarded to them. The "dead man's" father, himself an old soldier, noticed the discrepancy in the serial number, but thought it an accident. Soon the family received payment on the life insurance policy.

"My family was sure glad to find out I was alive after all", Lt. Fitzpatrick recalls. "But it took months to get the War Department to admit I was really alive."

IT'S A SMALL WORLD when Sgt. Frank Debnan of the Band in Compartment C-1 spots the name of a soldier from his own section of Henderson, N.C., the section being of a population of 4,000.

The name spotted was that of Pvt. Walter B. Harris which was run in the Personal column of the WARRIOR 10 August. Sgt. Debnan would like for Pvt. Harris to come to Compartment C-1 and visit him.

ATTEND RELIGIOUS services today.

FIND IT BY using the WARRIOR Want Ads.

GREELY 70 TIMES BIG AS MAYFLOWER

The Mayflower, famous sailing ship which carried the Pilgrims to the new world 330 years ago, was a 180 ton vessel. Her motive power was the wind, and it took her two months and five days to cross the Atlantic.

In those days, a man would have been branded a dangerous liar had he dared forecast such ships as we are traveling on. For the USNS Gen. W. W. Greely is almost 70 times as large as the Mayflower. And the winds make no difference to her.

The motive power of our sea-going hotel is furnished by a Westinghouse steam turbine capable of producing 9,000 horsepower.

This force is channeled through a set of double reduction gears that turn the single, three-bladed screw, moving the 12,000 ton vessel over the waters of the world at a steady speed never dreamed of in the heyday of the sailing ship, a scant 100 years ago. Our exact speed is secret.

The outside diameter of this propeller is about 21 feet. The blades are approximately four feet across at the widest sections.

Fuel oil is burned to make the necessary steam out of the 1,000 gallons of distilled water, produced in the Greely's own water distillation plant.

This distillation plant can turn 35,000 gallons of salt water a day into water suitable for washing, drinking or cooking as well as for making steam.

The capacity of the ship's fuel tanks is secret, but a broad hint as to their cubic volume can be deduced from the fact that a string of more than 20 boxcars loaded with large drums of oil would be required to fill these tanks.

Mr. Ed Minor, Chief Engineer of the Greely, is understandably proud of the compact engine room that is under his charge. It requires a staff of 30 assistants in addition to the affable chief to keep this power plant in operation.

A casual look at the maze of pipes, wires, wheels and pistons that fill the engine room will convince you of the genius of the American shipbuilders. The 800 foot keel of the Greely was laid down in Richmond, Calif. in the late days of World War I. Since that time the ship has traveled thousands of miles.

The log of one voyage embarked on in April of this year will give you a small idea of the journeying un-

RADIO OPERATION 'ROUND CLOCK JOB

Twenty-four hours a day, seven days a week, the radio room is humming on every ship. Aboard the USNS Gen. A. W. Greely three men take their four hours on and eight off day after day, tending to one of the most vital jobs on the vessel.

The radioman's job includes transcribing, via dots and dashes, a three to four page news broadcast from San Francisco daily.

Aside from special official messages, "it's mostly pretty routine" according to Chief Radio Operator Clifford Myers.

Myers is a man of long radio experience, and has been aboard the Greely for eight months. He has been a member of the Army and now holds a Naval Reserve commission.

John Carrol, Boston, Mass., another member of the radio section, has been aboard since July. During the war he served a long hitch with the Air Force during which time he assisted in establishing air wave stations for the expanded wartime air fleet. After 30 months in the ETO he studied electronics at Harvard University.

James Parish, Fulton, Ky., the third man on the radio team is a graduate of the Maritime Service Radio school at Hoffman Harbor, N. Y.. He has been working for the Civil Service radio since December 1946. Parish has been aboard the Greely since April.

OUTDOOR THEATER

Special Service Sergeant Robert Estes today stated that in the event of continued good weather, movies would be shown in the vicinity of Hatch #6, amidships topside.

Announcement as to place of showing will be made over the public address system.

Pfc. Ray Garretson, East McKeesport, Pa., is one of the men who extended his enlistment (before one year extension) in order to go with the Second Division on this pleasurable jaunt.

Attend religious services today.

done by the hard-working crew.

They sailed from New York City to Germany with troops; loaded Displaced Persons for Australia from Bremerhaven; picked up Dutch troops in Java and returned them to Holland and again loaded DPs, this time for New Orleans. From there they proceeded through the Panama Canal to Seattle and Tacoma where they acquired their present passengers.

SOLDIER HERE THE GREAT FATE

The Great Fate Hayes, boxer, baseball pitcher and basketball player among us as a casual.

There is no misspelling of the name, its just as you see it. It seems that when Hayes was born, his parents turned to the Bible and opened it at random. They next placed their finger on a portion of the page and young Hayes came out with the name, The Great Fate.

So much for his name. His baseball achievements with the semi-professional San Francisco Tigers in 1943 established him as a promising pitcher. He copped 22 decisions while dropping but seven.

Forsaking a baseball career The Great Fate joined a bigger team in 1943--the Army. His fistic start here was good as he took 16 out of 22 fights before retiring from this sport. In the six losses, Hayes took the long count three times.

Bringing the all-round athlete as near up to date as possible considering the present crisis, Hayes played a close guard position on the M Company Mules basketball team last season. The Manchu company team captured the regimental crown.

The San Francisco born veteran served with the Army during the last war in the battle for Luzon.

RANSOM LEADS TAM O'SHANTER

CHICAGO---Leathery old Henry Ransom calmly putted his way to a 3-under-par 69 to take the lead in the Tam O'Shanter \$55,000 World Golf Championship with a second round total of 139.

DIMAGGIO BENCHED

NEW YORK---Jolting Joe DiMaggio, the New York Yankee's brilliant outfielder, was benched mainly because of a batting slump for the first time in his career Friday night as the club took the field for a game with the Philadelphia A's.

DAVIS CUP SINGLES UNDERWAY

RYE, N.Y.---Australia and Sweden split the opening singles matches in the Davis Cup inter-zone tennis finals as Lennert Bergelin, the barefoot blondo, upset Frank Sedgeman, 2-6, 6-2, 7-5, 1-6, 6-3, while John Bromwich blasted Torsten Johansson, 6-2, 6-3 and 6-0.

SPORTS

BASEBALL YRMS AGRED BY PROBLEM CHILD

SAN FRANCISCO---The fellows who are nearly a crack to get a crack at the major leagues next season have opposing views on the subject of the big time.

Cap Dick Thompson, a former major league pitcher and now playing in the Oakland Oaks, says he will quit baseball unless he gets back up.

Another, Jim Wilson, ace hurler for the Seattle Mariners, is content to stay in the minor leagues, because he figures he will make more money right where he is.

YESTERDAY'S BASEBALL RESULTS:

American League:

Cleveland 5, Chicago 2
New York 7, Philadelphia 6
Washington 5, Boston 2
Detroit 4-1, St. Louis 3-2

National League:

New York 3, Philadelphia 1
Boston 7, Brooklyn 0
Chicago 3, Pittsburgh 1
Cincinnati 5, St. Louis 2

Pacific Coast League:

San Diego 9, Los Angeles 8
Seattle 8, Oakland 1
Hollywood 4, Portland 2
San Francisco 1, Sacramento 0

FUNERAL SERVICES FOR JOCKEY

DEL MAR, Calif.---Funeral services for apprentice jockey John Glissor 17, killed in a horse fall Thursday will be held Saturday, United States time.

BOXING SHOWS SCHEDULED

ABOARD GREELY

Daily boxing shows are in prospect for troops aboard the Greely if enough men sign up to take part in the bouts. Prizes will be awarded the winners of each bout.

Anyone desiring to participate in these bouts should contact M/Sgt. H. Estes in the ship's library. At least eight men must sign up to permit a four bout card to be staged before any shows are put on.

A portable ring will be set up in No. 6 hatch and bouts will take place in the afternoon. Men will be as evenly matched as possible, and all safety devices, including head gear and mouth pieces, will be furnished.

Boxers in all weights and classes are desired.



"Sam...would you care to see a bubble-bath demonstration?"



"Guess what? We're out of coffee!"



"No, I didn't, but thank you very much."

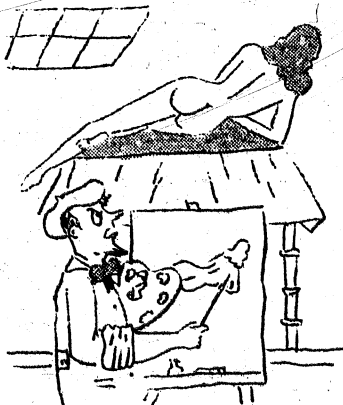

"Please, Miss Jones -- stop smiling."

WARRIOR

Vol. 2, No. 6

THE WARRIOR

1 September 1950

'38TH PARALLEL QUESTION UP TO UN' --- ACHESON

WORLD NEWS

WASHINGTON,--(P)--The Air Force reported today that North Koreans are rebuilding air fields and extending runways considerably above the 38th parallel. An air force spokesman told newsmen at a Pentagon briefing that the activity is along the Northeast coast at Pyongyang.

WASHINGTON,--(NS)--The senate today voted to give President Truman power to draft government-educated doctors, dentists and medical specialists with no previous military service.

WASHINGTON,--(P)--The House passed today legislation aimed at a general tightening of laws dealing with spying, sabotage and subversive activities. It requires communist party members to register.

LAKE SUCCESS,--(AP)--The United Nations security council agreed late today to a full airing of the Formosan problem.

LAKE SUCCESS,--(INS)--Pakistan informed the United Nations today that it will not be able to send troops to bolster UN Forces in Korea, but that it will contribute 5,000 tons of wheat toward the UN war effort. The Asian republic said that it would not furnish armed troops because of the situation regarding Kashmir.

PAYDAY--PAYDAY--PAYDAY

Payday??? Yes. According to Memorandum 72, Headquarters 2d Inf. Div., dated 30 Aug. 1950, individuals may receive any amount of their accrued pay they desire. Only those units or individuals who request pay will be paid.

In order to accomplish such payments it will be necessary for personnel officers to furnish the 2d Inf. Div. Finance Office with a list or roster of all personnel assigned or attached to their command they desire to have paid, and the amount of the desired payment specified thereon, i.e.; All. Mns, \$10.00, 20.00 ect. Rosters should be furnished the Division (cont on page 2)

Secretary of State Dean Acheson said, "It is up to the United Nations to decide whether forces should continue beyond the 38th Parallel which divides North and South Korea.

He said that in case events might take such a course, that the question of crossing the dividing line would solve itself.

By this, the secretary said, he meant that there would be no problem if the North Koreans ceased hostilities as demanded by the UN Security Council and cooperated in working out unification for Korea.

Acheson also said that the United States, by word and deed is doing its utmost to discourage Chinese Communists from becoming involved in the Korean fight.

Acheson also branded as a form of propaganda a message alleged to have been written by 38 American prisoners of war urging immediate withdrawal of US Forces from Korea. Russia's Jakob Malik submitted the message to the UN Security Council Tuesday. Acheson said some government used pressure to extract such propaganda from prisoners of war. He suggested that North Korea permit international Red Cross observers to interview the prisoners as General MacArthur has done in South Korea.

On other world problems, Acheson ridiculed the Communists election laws for the Oct. 15, one-time balloting in East Germany. The secretary declared this is a "brazen and typical Communist degradation" of the Democratic process.

In casting these ballots, Acheson said, the law requires persons not voting the straight Communist ticket to make changes in front of a pro-communist voting board, thereby betraying themselves as non-Communists.

WASHINGTON,--(P)--President Truman expressed hope today that congress will wait until January to act on universal military training legislation.

INVEST YOUR P-Y IN US S.A.V.I.N.G.S BONDS

THE KOREAN SITUATION

The Korean 8th Division, which pulled the northern front inland from the east coast, counter-attacked yesterday and captured a considerable amount of arms and ammunition.

On the front of the ROK 6th Division, where the Communists are driving down the Ui-Song-Uihung-Yongchon-Taegu highway, a small force of enemy troops infiltrated behind the 6th Division line to the vicinity of Sangyong, nine and one half miles northwest of Yongchon, and 19 miles northeast of Taegu.

General MacArthur reported that warships shelled 27 targets discovered by shore observers and scout planes, and were shelling the road to the north. Among the 27 targets were five troop concentrations, which were destroyed with heavy casualties.

B-26 light bombers continued around the clock bombing of North Korean Communists. Flights took off at 6:15 AM on Thursday for targets in North Korea, while other B-26s landed at almost the same time after flying night intruder missions.

The Air Force said fighters have concentrated chiefly on close support missions the last few days in assisting ground troops of the United Nations.

The fighters have flown the largest percentage of sorties, which have been running between 500 and 600 daily sorties of all types.

Marine Corsairs, under operational command of the 5th AF, worked throughout the night on night intruder missions in southwest Korea. One flight struck a large convoy at Kumsam, using napalm bombs with excellent results. Seven trucks were destroyed. Other Corsairs rocketed and strafed roads and vehicles between Chinju and Kumsam.

(cont from page 1)

PAYDAY

Finance Office five (5) days prior to date of payment.

Rosters should reflect the method of payment desired by individuals, i.e.: (1) Cash (Military Payment Certificate). (2) Treasury Check with limited indorsement. (3) Savings Bonds, or (5) Soldiers Deposits.

Individuals should be encouraged to make maximum use of all-otments as means of disposing of pay accruing to their credit.

HIGHLAND TROOPS ARRIVE

Two British warships brought 1,500 men of the Argyll and Sutherland Highlanders and the Middlesex Regiments from Hongkong; a hand-picked anti-tank unit is due to arrive soon from the British crown colony of Hongkong.

Supported by strafing planes and round-the-clock barrages from naval vessels standing off-shore, U. S. Troops and tanks charged into Pohang which the Communists convoy are trying to encircle.

In last night's fighting, the Communists got within 300 yards of the center of town, and then were pushed back. The North Koreans set up a roadblock on the highway from Pohang west to Taegu.

On the Southern front, U. S. troops captured Sobuk-San ridge, 34 miles west of Fusan. Twenty miles Northeast of Taegu, South Koreans fell back to positions three miles south of Uihung, but other South Koreans recaptured Kigye, Northeast of Pohang.

IN THE AIR

B-29 Superfortresses hammered Chongjin, 60 miles south of Russia, and other North Korean targets. They dropped 230 bombs on installations at Seishin with no opposition. B-26 light bombers struck at West Coast supply lines south of the 38th Parallel.

GEN. WALKER VISITS SECOND

"I feel that our front is secure. I am certain that any enemy penetrations in the future will be eliminated," Lt. Gen. Walter H. Walker, commanding general of the Eighth United States Army in Korea, said Tuesday morning at Second Infantry Division headquarters.

"The situation generally looks brighter than it has at any other time in the past two or three months," Gen. Walker added. The general said that he "wasn't worried" about reported enemy troop concentrations. He also said that "large numbers" of the North Korean army are drafted young South Koreans who "will quit whenever they get an opportunity."

Gen. Walker arrived at the Second Division's forward command post in a jeep which had picked him up at a nearby flight strip after he had been flown in from his headquarters. He was met at the flight strip by Maj. Gen. L. B. Keiser, commanding general of the Second Infantry Division.

HEADQUARTERS
EIGHTH UNITED STATES ARMY KOREA
Public Information Office
APO 301

SECRET

6 August 1950

INSTRUCTIONS FOR WAR CORRESPONDENTS:

1. These instructions supersede all previous instructions issued orally or in writing. Henceforth no reference need be made to previous instructions.

2. This is NOT uncensored war any more than the last war was uncensored. The only difference is there is NO MILITARY censorship. The Supreme Commander expects the correspondents to impose self-censorship and to refrain from publishing matter that violates security, endangers operations, gives aid and comfort to the enemy and weakens our war effort.

3. It is the policy of the Commanding General, EUSAK, to take correspondents into his confidence and to keep them well informed. Naturally this entails releasing classified information which cannot be published and it is given to correspondents for background material, to aid them in objective reporting and to insure their safety while on reconnaissance in the battle areas. The Commanding General, EUSAK, has been authorized by the Supreme Commander to deal with correspondents as he sees fit.

4. One copy of all news dispatches whether filed by telephone or teletype must be sent to PIO Eusak for his files. News releases will not be checked for security by PIO EUSAK unless the correspondent so requests in writing in the head of the release. Correspondents are invited to have their copy checked and are assured that these checks will cause no unusual delay in transmission.

5. Telephone communication for the transmission of news releases will be available to correspondents at Headquarters EUSAK daily between the hours of 0200 and 0400. Administrative calls may be made at any time but they must be limited to three minutes. Headquarters EUSAK reserves the right to "break" any telephone call if an emergency arises.

6. The following is offered as a guide to correspondents in observing security regulations: Generally, no hard and fast rules can be set down about security. Every plan, every withdrawal, every attack calls for new and different considerations and no fixed rule can be set forth to apply in every case. But in the main the following should be helpful to correspondents.

a. The arrival in Korea of new units, their designation, strength, composition, location and possible time of employment should not be mentioned until released by PIO EUSAK.

b. The arrival and assumption of command of general officers should not be mentioned until announced by PIO EUSAK.

c. No mention should be made of operations plans.

d. During lulls when both forces are regrouping for another attack, no mention should be made of location of units, their designation, strength and composition until units all along the lines are definitely engaged with the enemy. The releases should generally be withheld until announcement by PIO EUSAK.

e. Occasionally for morale purposes it is desirable to mention units and individuals in violation of paragraph 6, d, above, but such releases should invariably be cleared through PIO EUSAK.

f. Friendly losses should never be divulged except on authority of this headquarters.

g. The announcement of the commanding general's visits to the battle area should be held to a minimum.

h. The names of individuals missing in action should not be mentioned until authorized by PIO EUSAK.

-continued-

INSTRUCTIONS TO CORRESPONDENTS: continued

7. Correspondents will be briefed at least once daily -- oftener if necessary. Briefing will include two parts -- restricted and non-restricted. The latter, of course, may be published. PIO will endeavor to hold the morning briefing not later than 1100 hours daily. Afternoon time for briefings will be announced in advance.

8. In order to make it absolutely clear to correspondents about announcing the arrival and commitment of new units, the following should be borne in mind: The announcement of the arrival of a new unit or the commitment of any unit to a new front or sector will not be announced until we are sure that the enemy has its identity. The best proof of this is the loss of prisoners or our dead left within enemy lines. This announcement should be checked with PIO EUSAK.

9. The capture of prisoners and the treatment the U.N. forces accord prisoners should be announced immediately. Victories should be announced forthwith, naming the individual units and lower units if their performance was outstanding provided the information does not disclose future plans.

10. If correspondents desire to visit the commanding general or members of his staff, the request should be submitted through PIO EUSAK.

11. Unwarranted criticism of command decisions and of the conduct of soldiers on the battlefield are frowned upon and may subject correspondents to disciplinary action.

12. Correspondents are urged to present grievances to PIO EUSAK and to consult with him whenever they believe he can be of assistance to them. He is available to them at any hour of the day or night.

R. L. Thompson

R. L. THOMPSON
Lt. Col. FA
PIO, EUSAK

COPY

SECRET

011810K

FM : EUSAK

CITE 21896

KPI

TO: ALL MAJOR COMMANDS

MSG CX 60924

CINFE

FOR YOUR INFO :

SUBJECT : Policy guidance on issuance of communique issued by your headquarters.

1. No report on information concerning planned activities.
2. No enemy movement with respect to our boundary, weakness in position, or unfortified positions.
3. No information concerning effectiveness of specific items of enemy materiel.
4. Report only these activities or locations of friendly troops where continuous contact exists.
5. Reports as provided in paragraph 6 below give no report on identity of units until unit has been committed to combat and individual (?) of unit have been reported officially as missing. In no case give designation lower than division. Lesser units can be referred to as elements of parent division.
6. For non-divisional units, that is, separate brigades and regiments, designations will indicate only the parent unit, with lesser unit referred to as elements of parent organizations. This policy shall apply both to U. S. and other U. N. organizations which may be employed in Korea.

TOR 012240K

COPY

SECRET

Fin Sect

HEADQUARTERS 2D INFANTRY DIVISION
Office of the Finance Officer
APO 248 c/o Postmaster
San Francisco, Calif

JEE/ttj

AMBFO

9 September 1950

SUBJECT: Historical Report

TO: G-2 2d Infantry Division
APO 248 c/o Postmaster
San Francisco, Calif
ATTN: Historian

In compliance with instructions contained in Memorandum No. 72,
Headquarters 2d Infantry Division, Historical Report of this office
is submitted herewith.

FOR THE DISBURSING OFFICER:

Incl:
Historical Report

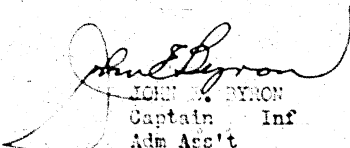
JOHN W. BYRON
Captain Inf
Adm Ass't

SECRET

HISTORICAL REPORT
Division Finance Office, 2d Inf Div
Period 9 July 50 - 31 Aug 50

1. ALERT NOTICE
2. PREPARATION
3. MILITARY PAY RECORDS
4. ALLOWANCES
5. ADVANCE PAYMENTS
6. PROCESSING OF CASUALS
7. DEPARTURE
8. AS INVICIES ENROUTE
9. ARRIVAL
10. NEW LOCATION
11. CURRENT ACTIVITIES

SECRET

HISTORICAL REPORT
Division Finance Office, 12d Inf Div
Period 9 July 50 - 31 Aug 50

1. Alert Notice. On 9 July 1950, this office received orders alerting it for overseas movement.

2. Preparation. Immediately upon receipt of orders, preparation for shipment was begun.

a. Requisitions for necessary boxes and crates were prepared and submitted without delay.

b. Supplies of blank forms for a period of 90 days were requisitioned and received.

c. A total of 174 boxes and crates were prepared and packed and this office was physically equipped and ready for shipment on 1 Aug 50.

3. Military Pay Records. Alert orders were received at the time when the semi-annual closing of all Military Pay Records was being effected.

a. During the period prior to departure, 14,119 Military Pay Records were computed, audited, closed and forwarded to the Military Pay Division.

b. During the same period, a like number of Military Pay Records were computed, audited, closed and forwarded to the Military Pay Division.

4. Allotments. Information pertaining to allotments was disseminated to all elements of the division and an intensive allotment processing operation was begun.

a. During the month of July 11,500 allotment applications of all kinds were processed by this office and were forwarded to Army Finance Center, St. Louis, Missouri.

b. At this date 17,200 Class 1 Allotments for National Service Life Insurance are in effect.

5. Advance Payments. A total of 17,500 advance payments were made at St. Louis, prior to departure.

6. Processing of Casuals. 2200 replacements were given financial processing by this office. Of the total, 450 were processed at sea. During these operations 638 temporary Pay Records were opened.

7. Departure. On 5 August 1950, this office with,

3 officers, 1 WC,	Fin
1 officer	Inf
1 officer	QM
1 officer	Armor
49 EM	Fin
2 EM	Inf

departed Ft. Lewis, Washington, and embarked on the U.S. Transport Horace W. Greeley, sailing from the Port of Tacoma on the same date.

8. Activities Enroute. a. As noted in paragraph 6, above, limited finance activities were conducted at sea. Four hundred-fifty casuals were processed, given advance payments, and temporary Pay Records were opened.

b. Treasury checks were prepared for those who desired to send money to the United States. One hundred eighty-one such checks were prepared and issued.

c. U.S. money was withdrawn from troops preparatory to exchange for script.

9. Arrival. a. On 19 August 1950, the Greeley arrived at Pusan, Korea. Here U.S. Currency was exchanged for Military Payment Certificates, and the Division Finance Office debarked on 20 Aug 50, arriving at Samnangjin, Korea, as its initial point of assignment.

b. At Samnangjin, equipment and office supplies were unloaded and preparation made for move to Miryang, Korea. Funds in script and won were obtained from Pusan.

10. New Location. a. On 27 August 1950, the office entrucked and moved to Miryang, Korea, a distance of approximately 12 miles north of Samnangjin.

b. A building vacated by 24th Inf Div Finance Office, and formerly the Tax Collectors office for the area, was utilized as office space.

c. Personnel were billeted under canvas within the compound, and attached for rations to the 5076 MASH, an adjacent unit.

11. Current Activities. a. The Finance Officer maintains a supply of Korean Won for the purpose of exchange and for funding Class 1 Agents, appointed as Labor Officers.

b. An indigenous Accounts Section was established for handling of local supply and Labor obligations.

c. Full scale finance service was established as required by the demands of the division.

d. Recommendations for a new finance T/O&E to cover 4 officers 1 W/O and 50 men submitted September 1950. Maintenance of own security guard small factor in recommendations.

FOR THE DISSEMINATING OFFICER:

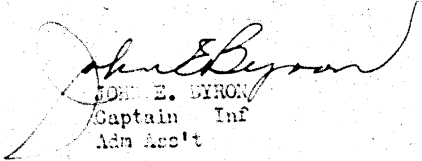
JOHN E. BYRON
Captain Inf
Adm Ass't

SECRET

SAMPLE COPY

~~SECRET~~

Public Information Office
Second Infantry Division
APO 248 c/o postmaster
San Francisco, California

WITH THE U. S. SECOND INFANTRY DIVISION IN KOREA---Using a 105 mm howitzer like a doughboy uses his rifle, Lt. Robert E. Parke, Alameda, Calif., killed at least 60 North Koreans and saved his field artillery battery position from being overrun.

The story came out last week, when artillerymen of the Second Division told of the fighting in the Naktong river bulge area when the Reds broke through in the early morning hours of September 1.

Lieutenant Parke's battery was emplaced in the vicinity of Hill 409. When the attack came, he sighted down the open bore of the field piece at the onrushing Reds until they were in point blank range. Then he would fire.

Saved by this action, the battery was able to re-establish its positions and continue the battle.

-30-

Mailed to: Alameda papers
Stars and Stripes
Army Times

SECRET

PM Sect

SECOND MILITARY POLICE COMPANY
Second Infantry Division
APO #248 & Postmaster
San Francisco, Calif

SECRET

11 September 1950

SUBJECT: Command and Unit Historical Report

TO: Commanding General
2d Infantry Division
APO #248 & Postmaster
San Francisco, Calif
ATTN: Division Historian

1. In compliance with Staff Memo 9, Hq 2d Inf Div, dtd 29 Aug 50, the following report is submitted:

"On the 8th of July, 1950, this organization was alerted for shipment to FROCK. All leaves were cancelled and TWX's were sent to personnel absent from the post ordering them to report back immediately. Our only Garrison Prisoner in confinement (Rot Alexander J McCarthy) was returned to duty. Captain Harry W Bender was in command. On the 9th of July, all available personnel performed usual organizational duties and the first Enlisted Man returned from leave. On the 10th day of July 1950, this organization was relieved from Post Military Police duties and the immediate training and indoctrination of all personnel was begun.

On the 11th and 12th of July, nothing unusual happened. Training and indoctrination program was in full swing, with changes being made as they were needed. Personnel previously stationed in the Far East were utilized to the fullest extent in the orientation and training of personnel. Nine (9) Enlisted Men extended their enlistments in order to accompany this organization-proof of a high 'Esprit de Corps'.

The 13th of July, in addition to training and indoctrination of personnel, one traffic platoon was assigned to each of the Infantry Regimental Combat Teams, components of the 2d Infantry Division-the 9th, 23d & 38th Inf Regts. This in compliance with plans to form Regimental Combat Teams. By the 14th of July 1950, all personnel had returned from leave and TDY. All 6006 ASU (POO) attached personnel were returned to their parent organization. 16 EM were assigned from the 6006 ASU and 22 EM were assigned to the 6006 ASU from this organization. Captain Richard S Johnson assumed command vice Captain Harry W Bender, who was relieved due to school assignment.

On the 15th of July, Pay Day was advanced and all personnel were paid in full for the month of July. This was done for the convenience of personnel in settling of their private affairs.

SECRET

SUBJECT: Unit Historical Report (Cont'd)

SECRET

On the 16th & 17th of July preparations for overseas movement were begun with all sections working overtime willingly and in high spirits to accomplish the many tasks ahead before this organization would be ready. On the 18th of July, the unit continued with its program as prescribed by circumstances and the first Officer and Enlisted Man-1st Lt Keith E Cress & Pfc Asher Daniel- departed for FEOCM with the advanced party of Hq 2d Inf Div.

On the 19th of July, 1950, the unit reorganized under TO&E 19-27N as authorized by General Order #87, Hq 6th Army. The Company was brought to full wartime strength of 7 Officers and 180 Enlisted Men. 1st Lt Leon D Sexton and 36 EM departed with the 9th RCT for FEOCM. On the 20th of July, the company continued with its usual preparations and training, while the 1st Platoon was aboard the USNS General D I Sultan, on which they assumed part of the guard responsibilities, such as maintaining order and discipline in the mess, PX and movie lines, as well as guarding the War Room and maintaining a deck. The 21st of July found the company continuing with its preparations and training, and the 1st Platoon held classes on individual weapons aboard ship.

At Fort Lewis on the 22d of July, 1950, 1st Lt Oscar J Weible and 33 EM departed with the 23d RCT for FEOCM, while the company's preparations and training approached completion. Meanwhile on board the USS General D I Sultan, the 1st Platoon continued on board ship the training outlined by Company directives. On this date, the APO number was changed from 241 to 248.

From the 23d of July to the 28th of July inclusive, all elements of the company, regardless of their station, were actively engaged in training. At Fort Lewis, the remaining personnel were rapidly bringing to a close the preparations necessary for overseas movement. 2d Lt Calvin L Larson and 27 EM departed with the 38th RCT on the 29th of July, and 11 EM were assigned from the 2d Repl Co. Our overall strength at this date was 8 Officers and 160 EM, leaving our overall shortage at 20 EM. The 1st Platoon continued with its shipboard training, bringing its men to a high state of efficiency. Lectures and discussions aboard ship by and with personnel previously stationed in the Far East, greatly increased the limited knowledge of the Far East and its people, customs, and terrain.

The 30th of July found the entire company actively engaged in its training and preparation program. At Fort Lewis, replacements were received, bringing the company to full strength plus. Overall strength at this time was 8 Officers and 161 EM, and an overage of 1 Officer and 1 EM. Through the press and radio, it was learned that the 9th RCT had landed in Pusan, Korea. At this time, the 1st Platoon assumed responsibilities for dock security at Pusan. Speculation as to the possible landing place of the rest of the Division gave rise to many rumors, which were squelched in the bud by aggressive action on the part of Officers and Non-Coms.

On the 1st of August 1950, preparations and training were completed, with a small prayer and hope that nothing had been overlooked. Later, it came to light that all training and preparations had been of extreme importance to the accomplishment of our unit mission. Officers and EM who engaged in the drawing up of plans for training and preparations are to be congratulated and should be gratified to think that their contribution, however small, would be

SECRET

SUBJECT: Unit Historical Report

SECRET

responsible for the efficient actions of this unit. In Korea, the real test of the worth of the training was rapidly coming. The 1st Platoon assumed traffic control responsibilities for the movement of the 9th RCT to Kyong-san.

Meanwhile, at Fort Lewis on the 2d August 1950, Captain Johnson, 1st Lt Cattanach, 1st Lt McCombs and 69 EM departed for FECOM on USNS General William T Mitchell. Major Becker and 15 EM remained behind, to follow at a later date. At Kyong-san, Korea, the 1st Platoon established traffic control points in that area. The platoon was augmented at that time by 10 EM from I & R platoon of the 9th Inf Regt, who were utilized for traffic control. 1st Lt Sexton and SFC Strohm made a road reconnaissance to TAEJU for the possible movement of the 1st Bn, 9th Inf Regt. 3 Aug 50-Major Becker boarded USNS General William T Mitchell and 15 EM were left to follow under SFC Siegfried. In Korea, Cpl DiVecchio, with 1st Bn, 9th Inf, and Sgt McClure, with 3d Bn, 9th Inf, departed on road reconnaissance. 1st Bn reconnaissance encountered enemy under fire from US planes. Both returned with valuable information as to road conditions, road width, possible trouble spots, etc.

Aboard the General William Mitchell on the 4th of August 1950, the main body of the company drew up plans for training personnel, while in Korea, the 1st platoon performed field MP duties. The 5th of August ~~found~~ the company fully absorbed in their duties at hand. Discussions increased limited knowledge of specific incidents and aided immensely in raising combat efficiency to a high level. On the 6th of August, the portions of the company at sea diligently applied themselves to the task of fully preparing themselves to accomplish the tasks about to be set before them. And at Kyong-san, Korea, the 1st Platoon was actively engaged in proving or disproving the theories learned in class by actual performance. Sgt Burket and Cpl Ferrone were sent on road reconnaissance with Colonel Sloane. More traffic control points were established. Lt Sexton and Sgt McClure and Sgt Randall departed with the 1st Bn, 9th Inf Regt, on their movement to the 24th Inf Div Sector. Our vehicles were fired on by snipers, and Lt Sexton's jeep was hit by small arms fire. Damage was negligible, consisting of a small dent in the center of the hood.

At sea on the 7th of August 1950, the company continued its training. In Korea, the 1st Platoon established traffic control points for movement of the 3d Bn, 9th Inf Regt. This was a practice situation however, and no actual movement was made. The I&R platoon of the 9th Inf Regt was detached and returned to their parent organization. On board ship on the 8th of August, the company was still engaged in training. While in Korea, for the 1st Platoon, training had ended and the platoon was committed to combat with the 9th Inf. Earlier that date, the platoon escorted the 1st & 2d Bn, 9th RCT, to Yongnan, where the RCT was attached to the 24th Div. Pvt Frederick Foster was evacuated by the 24th Medical Bn for heat exhaustion and possible hysteria. Road reconnaissance patrols had traveled to the front lines and met sniper fire enroute. Pfc McCarthy's vehicle was hit by enemy shrapnel at the 24th Div CP, causing the loss of 1 five (5) gallon Gasoline can. In Yongnan, the 1st Platoon CP was under heavy enemy artillery fire. Sgt Burket and Cpl Ferrone returned with valuable information from the reconnaissance on which they had departed on the 6th of August. Sgt Townesend and Cpl Sewell were placed in charge of 2 P.W.'s, who were to be held for CIC interrogation. After interrogation, the P.W.'s were to

SECRET

SUBJECT: Unit Historical Report

SECRET

be taken to the Korean National Police, but enroute, enemy artillery killed 1 P.W., who hit by shrapnel in the head.

Shipboard training continued on the 9th of August 1950, for those members of the company still at sea. But in Korea, Straggler Control and Collecting Points were established in forward and rear sectors of the 9th RCT area. At the platoon CP in Yongman, a PWE was established and agents from the 2d CIC Det were established in the platoon CP to effect closer coordination of efforts. This coordination resulted in closer and more efficient operation of both services. The platoon was still under enemy sniper and artillery fire.

The 10th of August found the company continuing their prescribed duties, with no let-up from enemy snipers and artillery for the 1st Platoon in Yongman. The main body of the company was still at sea on the 11th of August, and in Korea, the 1st Platoon was forced to evacuate Yongman because of the constant enemy artillery fire, by order of the 9th Inf Regt, which had become increasingly accurate within a few hours. Elements of the platoon directed traffic underfire until movement of troops from Yongman was completed, and a new CP was established west of Yongman towards the front lines. During the evacuation of Yongman, Lt Sexton and Sgt Keiser were hit by enemy shrapnel. Both were treated by 9th RCT Medics and returned to duty. Later Lt Sexton suffered a shrapnel-sprained arm when he was struck and run over by a $\frac{1}{2}$ ton truck. Shipboard training occupied the members of the Company at sea on the 12th of August 1950, and in Korea, the 1st Platoon dispatched a squad on road reconnaissance for a new Supply Route, pending the reopening of the MSR, closed by enemy road-blocks. Enroute north on the proposed MSR, patrol encountered sniper fire. Straggler points were established at the 1st & 2d Bn & 9th RCT CP's. Over a 2 hour period, a check of stragglers revealed 40 EM from 34th Inf, 29 from 19th Inf and 9 from 9th RCT. All were returned by the most expeditious means to their organizations. All points in this area were under enemy artillery fire. The main body of the company was still absorbed in the duties at hand on the 13th of August 1950, while in Korea, the 1st Platoon reestablished traffic control points in Yongman. The MSR was reopened by elements of 1st Bn, 23d Inf Regt and 34th Inf. In Yongman, traffic control points were under sniper fire necessitating extreme safety measures.

On the 14th and 15th of August, the company continued their duties, Cpl Sewall evacuated by 9th Inf Medics-battle fatigue-, Pusan, Korea was reached by the main body of the company on the 16th of August 1950, and remained overnight in warehouses on the dock. Cpl Dominique suffered a fractured ankle when the gang-plank buckled during unloading operations. Cpl Dominique was hospitalized by the 8054 Evac Hospital. Inland, at Yongman, the 1st Platoon continued road reconnaissance. Sgts Burket & Townsend made a reconnaissance for movements of the 9th RCT to a rear area. Cpl Peter J Hopkins was evacuated by the 19th Inf Medics for heat exhaustion.

On the 17th of August 1950, the main body of the Company left the warehouses on the dock for Camp Hialeah, Pusan. The first platoon established special defile points between the 9th RCT rear CP and the front. One Officer and 19 EM departed Pusan via truck for Miryang on the 18th of August. CP was established at Sun-Ock-No. The remainder of the main body departed Pusan

SECRET

SUBJECT: Unit Historical Report (Cont'd)

enroute to Miryang on the 19th of August, 1950. 1st, 2d & 3d Platoons were relieved from attachments to the respective RCT'S and joined the main body at Sum-Cok-Ni, where the company was re-formed. On the 20th of August, a platoon relief system was established, whereby one platoon is kept in reserve at the company CP for the relief of other platoons. The Relief Platoons provide a minimum CP security, and would be strengthened for that purpose by filler personnel. One (1) Officer and 33 EM departed on the 21st of August for Changnyong area to establish PW enclosure, traffic control points, straggler collection points, and road reconnaissance patrols.

One (1) Officer and 33 EM established PW enclosure, traffic control points, straggler collecting points, and road reconnaissance patrols in the Miryang area on the 22d of August 1950. By the 23d of August, PW enclosures were in full swing under the direction of 2d Lt Larson and MSgt Robert B Gilmore, the investigator. Division CP Security responsibility was delegated to this organization. On the 24th of August, the bivouac area at Sum-Cok-Ni was evacuated, and the unit departed for Pugong-Nyon, a distance of 22 miles, with no accidents to mar our record.

Normal field MP duties occupied the unit from the 22d of August to the 28th of August inclusive. On the 29th of August, however, guerillas attacked one of our traffic control points. One guerilla was killed, and two others were believed wounded, but both escaped under cover of darkness. Effects of the dead enemy were released to the 2d CIG for evaluation. It is believed that the guerillas were attempting to infiltrate, but were discovered by our patrol, who opened fire. The Provost Marshal, 1 Officer, and 9 EM, with an equal number of Korean National Police left on the 30th of August for the Changnyong area. Acting on information from a refugee, the party contacted a Guerilla force of 6 enemy. One Guerilla was wounded and captured, the others escaped by what obviously was a pre-arranged escape route. The wounded prisoner was released to the 2d CIG Detachment for interrogation and evaluation of information. On the 31st day of August, on the Changnyong-Yongseon road, a convoy escorted by the Military Police was strafed in column. Three (3) 2 1/2 Ton Trucks were hit and immobilised. The plane was unidentified and passed on after one pass at the column. The convoy resumed travel after the damaged vehicles were removed from the road.

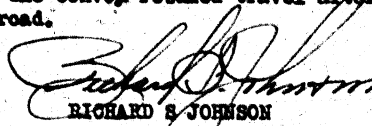

RICHARD S. JOHNSON
Captain MPO
Commanding Officer

SECRET

Sp Sv Sect

HISTORICAL REPORT
Division Special Service
2d Infantry Division

SECRET
FOR THE PERIOD 9 JULY - - - 31 AUGUST 1950

On 9 July 1950, the Second Infantry Division, stationed at Fort Lewis, Washington, was alerted for overseas shipment. At the time of the alert, the Division Special Services Section, was under the control of the Fort Lewis Special Services. A transfer of personnel from Post to Division, and vice-versa was made, in order to organize a Divisional Section for operations overseas. The following personnel, with duties as indicated, were selected:

Major Victor E. Strom	-Special Service Officer
Captain Albert A. Price	-Executive Officer
Captain Willie Kucera	-Post Exchange Officer
1st. Marshall Ottes	-Athletic Officer
M/Sgt. Robert Estes	-Sergeant Major
SFC Morris Ross	-PI Non-Commissioned Officer
Sgt. Anthony Aprea	-Athletic Non-Commissioned Officer
Cpl. Curtis Paulson	-Warehouseman
Cpl. Henry Shapinger	-Projectionist
Pfc. Harry Newport	-Warehouseman

One officer departed with the advance detachment.

On 11 July 1950, all units of the Division were instructed as to the required amount of athletic equipment to take TOE. Urgent calls were made to the Mayors of the neighboring cities of Tacoma, Olympia, and Puyallup, requesting donations of magazines and recreational material. Aid was also solicited from the Fort Lewis Chapter of the American Red Cross and Sixth Army Special Services. The Fort Lewis Welfare Fund donated one thousand (\$1,000.00) dollars to the Section for the purpose of purchasing items not available for issue.

Packets were prepared during 12 July - 4 August 1950, of gratuitous supplies collected and put aboard all departing ships, passenger and cargo, carrying Divisional personnel. These packets were to be utilized by all troops enroute to their overseas destination. Each packet was made up per passenger list strength, and included magazines, playing cards, small games, harmonicas, ocarinas, writing materials, and other miscellaneous items.

Several trips were made to the POE to check on the recreational facilities aboard ships, and ways and means of augmenting these facilities.

SECRET

SECRET

The Division Special Service Section sailed from Tacoma, Washington, aboard the USNS General A. W. Greely at approximately 1500 hours, 5 August 1950. During the voyage the Section was active in distributing recreational items, operating the ships library, assisting in the operation of the ships Post Exchange, showing movies, and sponsoring a one (1) hour band concert daily by the Second Division Band. Other entertainment offered was an impromptu soldier quintet, which toured the ship singing religious and popular songs. A member of the ships crew presented a magician act. All entertainment was enthusiastically received by troop personnel.

On 20 August 1950, the Section arrived at Pusan, Korea, and moved to Sannangjin, some twenty miles north of Pusan. The stay at Sannangjin was short, however, the activities there consisted of future planning, requisitioning available supplies from Eighth Army Special Services located at Pusan, and making distribution of available Stars and Stripes and other reading material.

On 25 August 1950, the Section moved to Miryang where a warehouse was set up to receive all incoming supplies. The first supplies received, included reading material, R-100 Radios, four (4) projectors, playing cards, writing material and PX supplies totaling twenty-one thousand (\$21,000.00) dollars.

On 29 August 1950, one officer and four guards departed for Tokyo, Japan, to purchase a prepaid liquor ration for the Division.

SECRET

SJA Sect

HISTORICAL REPORT
Division Staff Judge Advocate
2d Infantry Division

FOR THE PERIOD 9 JULY --- 31 AUGUST 1950

Any narration of Judge Advocate activities during the Korean Police Action would be sorely lacking in content if the story regarding the preparation for overseas shipment were disregarded. Effective 9 July 1950, "Division Alert Day", the Section operated seven days a week, with daily hours ranging from 10 to 14. The Section was confronted with a backlog of:

UNREVIEWED CASES

General Courts-Martial	34
Special Courts-Martial (BCD)	25
Special Courts-Martial and Summary Courts-Martial	<u>224</u>
	293
<u>Cases referred to General Courts-Martial and awaiting trial</u>	<u>42</u>
TOTAL:	335

It Colonel Burton F. Ellis, G-29033, JAGC, had assumed the duties of Division Staff Judge Advocate on 1 July 1950. His decision was that the entire backlog would be cleared prior to departure of the Division. The available personnel to do the job were twelve (12) officers whose duties were as follows:

Section Chief	1
Reviewing Officers	5
Law Member & Military Affairs	1
Trial Judge Advocates	2
Defense Counsels	2
Administrative Officer	1

It became apparent that the available personnel could not finish the job due to time limitation. The Sixth Army Staff Judge Advocate was called upon for assistance. He responded promptly by sending to Fort Lewis by air three (3) Reviewing Officers, three (3) stenographers and one (1) administrative non-commissioned officer. The staff, as implemented, completely cleared the work agenda on 25 July 1950, for on that morning General Keiser signed the last two (2) courts-martial actions. The accelerated program had moved at a fast pace, however, thoroughness and accuracy were not sacrificed for speed and the business at hand was efficiently and properly completed.

The Commanding General's policy changed abruptly following the alert announcement. It was considered in the best interests of the Service to salvage

HISTORICAL REPORT
Division Staff Judge Advocate
2d Infantry Division

FOR THE PERIOD 9 JULY --- 31 AUGUST 1950

Any narration of Judge Advocate activities during the Korean Police Action would be sorely lacking in content if the story regarding the preparation for overseas shipment were disregarded. Effective 9 July 1950, "Division Alert Day", the Section operated seven days a week, with daily hours ranging from 10 to 14. The Section was confronted with a backlog of:

UNREVIEWED CASES

General Courts-Martial	34	
Special Courts-Martial (BCD)	25	
Special Courts-Martial and Summary Courts-Martial	<u>224</u>	293
<u>Cases referred to General Courts-Martial and awaiting trial</u>		<u>42</u>
TOTAL:		335

It Colonel Burton F. Ellis, C-29033, JAGC, had assumed the duties of Division Staff Judge Advocate on 1 July 1950. His decision was that the entire backlog would be cleared prior to departure of the Division. The available personnel to do the job were twelve (12) officers whose duties were as follows:

Section Chief	1
Reviewing Officers	5
Law Member & Military Affairs	1
Trial Judge Advocates	2
Defense Counsels	2
Administrative Officer	1

It became apparent that the available personnel could not finish the job due to time limitation. The Sixth Army Staff Judge Advocate was called upon for assistance. He responded promptly by sending to Fort Lewis by air three (3) Reviewing Officers, three (3) stenographers and one (1) administrative non-commissioned officer. The staff, as implemented, completely cleared the work agenda on 25 July 1950, for on that morning General Keiser signed the last two (2) courts-martial actions. The accelerated program had moved at a fast pace, however, thoroughness and accuracy were not sacrificed for speed and the business at hand was efficiently and properly completed.

The Commanding General's policy changed abruptly following the alert announcement. It was considered in the best interests of the Service to salvage

all potentially rehabilitatable personnel. Toward this end many punitive discharges, previously adjudged, were disapproved, and in such cases that portion of the sentence pertaining to confinement at hard labor suspended. Division personnel under sentence of punitive discharge for serious offenses and/or felonies whose record indicated aptitudes of the habitual offender type and who were considered to be of no apparent value to the Military Service, were re-assigned to station complement units and their records of trial forwarded to The Judge Advocate General for action pursuant to Article of War 50. A decided majority of the men who were returned to a duty status under the policy of utilizing all available manpower were considered excellent possibilities for field service. On personal interview they impressed the reviewer as being sincere and enthused at the chance of rejoining their units for combat duty.

Shortly after alert day a shortage of guards and prison chasers precipitated a program worthy of interest and speculation; that of clearing the Post Stockade of all minor offenders, sentenced and unsentenced. The responsibility of "pushing" this program was delegated to the Division Staff Judge Advocate. Within a matter of five (5) days the Stockade Morning Report revealed that only those remained confined who were awaiting shipment to Branch United States Disciplinary Barracks, those previously sentenced to punitive discharge and awaiting appellate review under Article of War 50 and 3 unsentenced prisoners alleged to have committed serious offenses whose release would have been contrary to the dictates of good social practice. The overall program resulted in reducing the stockade population from approximately 275 to 115, however, a lesson was learned in the process. A number of men convicted of military offenses and sentenced to punitive discharge, were released pending receipt of notice as to appellate review action. A number of these men either absented themselves without leave or promptly committed other offenses upon gaining their freedom. This experiment would indicate that this category of personnel should be retained in confinement until receipt of final appellate action.

The Section established a legal station in the Processing Center at Fort Lewis devised to ready some 5000 Division replacements for immediate overseas shipment. The replacements were advised and assisted on legal problems, issued powers of attorney, given assistance in the execution of contracts, wills and other required legal documents. This around the clock assignment was successfully completed in the period from about 15 July 1950 to 1 August 1950.

Throughout the preparatory period The Judge Advocate General gave Division records a high priority and splendid cooperation, but due to the unusual number of cases processed there were some legal sufficiencies not received on departure date for the Division. In these instances The Judge Advocate General approved the recommendation of this Section authorizing the Commanding General, Fort Lewis, Washington, to publish orders on Division Personnel whose appellate actions were received subsequent to the departure of the Division from Fort Lewis.

Embarkation date for the Section, travelling with Division Headquarters, was 5 August 1950. The good ship, USHS General A. W. Greely was assigned as the transport medium. The following personnel composed the section contingent:

Lt. Col. Burton F. Ellis, JAGC
Major Reginald E. Ivory, JAGC
Captain George F. McGuigan, JAGC
Captain Joe L. Stenhouse, JAGC
Captain Bruce C. Babbitt, JAGC
1st Lt. Stephen A. Day, Inf
1st Lt. Don W. Adair, Inf
CWO Carl E. Phillips, USA
M/Sergeant Roderic F. Rusch
Sergeant Leslie R. Weber
Corporal Joseph E. Tanner

Division Staff Judge Advocate
Asst Division Staff Judge Advocate
Asst Division Staff Judge Advocate
Asst Division Staff Judge Advocate
Asst Division Staff Judge Advocate
Trial Judge Advocate
Defense Counsel
Administrative Officer
Chief Clerk
Court Reporter
Clerk-Typist

During the voyage an office was maintained and legal services rendered to such troops aboard as were in need thereof. Only one court-martial was held on the ship, that being a minor offense tried by Summary Court-Martial resulting in a sentence to forfeit \$20.00 and a reprimand. The offense for which this accused was tried occurred prior to embarkation at Port Lewis. The behavior of the troops and personnel during the crossing was exemplary. The Section debarked on 20 August 1950, at Pusan, Korea, there upon coming within the jurisdiction of Commanding General, Eighth Army, United Nations Forces Leader in Korea.

On 15 August, Master Sergeant Rusch developed a severe swelling of both ankles which rendered walking extremely painful. His condition did not respond to treatment on board ship and the Division Surgeon ordered that he be transferred to the Hospital boat at Pusan for treatment. He was subsequently transferred to the 35th Station Hospital at Kyoto, Japan, and as of 31 August had not rejoined the Division. On 23 August 1950, while stationed at the Division (REAR) CP at Samangjin, Lt Adair was reassigned to a Heavy Mortar Company, 23d Infantry; and on the following day, Lt Day received orders for assignment to the 9th Infantry. Both officers requested tactical assignments which resulted in these orders. These personnel changes left the Section with: 5 Officers, 1 Warrant Officer and 2 Enlisted Men as of 31 August.

Since embarkation of Division units there have been relatively few trials, a total of only seventeen Summary and one Special Courts-Martial. Frequent visits to the advance units by members of the Division Staff Judge Advocate Section reveal that morale is high and discipline is being easily maintained. All Regimental Commanders and the Division Artillery Commander have been visited and advised that personnel of this Section are continuously available for investigations and the handling of any problems arising in the field on Military Justice. Close liaison is also being maintained with Lt Colonel Chester W. Silvers, JAGC, Eighth Army Judge Advocate. Members of this Section visited Eighth Army Headquarters immediately upon debarkation and discussed local policies and procedures. On 27 August 1950, Lt Col Silvers visited this CP at Miryang and offered assistance and advice on any unsolved problems.

With regard to the tremendous backlog confronting the Section at the time of the alert, further observation seems merited. It is submitted there should always be sufficient Judge Advocate planning and "within the Section coordination"

to prevent a steadily increasing backlog. Complicated inter-office communication should be simplified; extraneous discourse on immaterial matters should be entirely eliminated; the luxury of requiring needless reports and the maintenance of bulky, unimportant files should not be tolerated; and each assigned skill, professional and administrative, should be properly and fully utilized. It is further advanced that in the composition of allegations there should be strict adherence to the line of brevity, and clarity and watchfulness against unnecessary flourishes. Consistent with this practice an accused should be charged with only those offenses, upon the conviction of which, an adequate punishment may be adjudged. The practice of "multiplying" charges, even though it is apparent that the accused be technically guilty of all offenses, minor and serious, should be avoided.

The administration of military justice in a command should be maintained on a current basis at all times. The concept of American Jurisprudence that a person is entitled to the expeditious disposition of charges filed against him, based primarily on Constitutional guaranty, must be equally applicable in the Military establishment. The practice of allowing an accused person to languish for weeks in a stockade pending his trial or loiter in arrest of quarters, thus escaping the performance of military assignments for lengthy periods must be eliminated. It is incumbent upon those charged with the responsibility of the proper administration of Military Justice to insure that legal processes receive speedy disposition, being ever mindful of the fact that in so doing the substantial rights of the accused be not prejudiced. It is along those principles that the 2d Infantry Division Staff Judge Advocate Section is now constituted. Toward the aims of prompt and thorough action on all matter hereto referred, complete staff cooperation, and unlimited service to all field units, this Section now stands organized and so dedicated.

SCREENED By OCAFF
Date AUG 14 1951

SECRET
DEPARTMENT OF THE ARMY
THE ADJUTANT GENERAL'S OFFICE
WASHINGTON

302
Master



War Diary with Staff Sections - 2d Inf Div

OPERATIONS BRANCH A.G.O.

CLASSIFIED RECORDS

AGO MICROFILM
ITEM NO: 17
(cont)

SECRET

8
Sept
Oct
1950

SECRET

WAR DIARY



**HEADQUARTERS
2^d INFANTRY DIVISION**

1 SEP 50 — 31 OCT 50

SECRET

COPY No 1

SECRET

WAR DIARY

HEADQUARTERS
Second Infantry Division
APO 248, c/o Postmaster
San Francisco, California

From: 1 September 1950 Through: 30 September 1950
 1 October 1950 Through: 31 October 1950

Assigned To: 8th United States Army Korea,
Far East Command,
APO 301, US Army.

SECRET

SECRET

CONTENTS

1. Classified Announcement
2. Distribution
3. List of Inclosures (Supporting Documents)
4. War Diary - Record of Daily Entries
5. Staff Section Reports
6. Volume II Narrative Summary

SECRET

SECRET

ATTENTION

The material contained in this War Diary is classified SECRET in accordance with the provisions of AR 380-5 and Par 8, SR 345-105-1, 3 February 1949.

The following is quoted for the information and guidance of all concerned:

DISSEMINATION OF CLASSIFIED MATTER. No person is entitled solely by virtue of his grade or position to knowledge or possession of classified matter. Such matter is entrusted only to those individuals whose official duties require such knowledge or possession. (Par 11, AR 380-5)

SECRET

SECRET

DISTRIBUTION

Total Number of Copies Prepared:

War Diary - 7 Copies

Supporting Documents - 1 set with the following exceptions:

Maps Korea 1/50,000, PIR's 9-33 and 37-44, Periodic Logistics Reports for September 1950, which are in duplicate.

Copies 1-6 with supporting documents as indicated forwarded to the Commanding General, Eighth United States Army, Far East Command, for ultimate distribution as follows:

- (1) Four copies, including copy No 1, with supporting documents, to the Department of the Army.
- (2) One copy to Commander in Chief Far East Command.
- (3) One copy, with duplicate copies of supporting documents indicated above to Commanding General, Eighth United States Army, Far East Command.

NOTE: Copy 7 to be retained in files of Headquarters Second Infantry Division.

SECRET

LIST OF INCLOSURES

Staff Section Reports Headquarters 2d Infantry Division

C/S
G-1
G-2
G-3
G-4
Aviation Section
Chemical
Engineer
Ordnance
Quartermaster
Signal
Surgeon
Transportation
G-5
AG
IG
Public Information
Finance
Provost Marshal
Special Service
Staff Judge Advocate

Maps: Korea 1/50,000
G-2 Journal 1-30 September 1950
G-2 Message Files (September) (610-745, 746-862, 863-1001, 1002-1119, 1120-1287, 1288-1441, 1442-1553, 1554-1684, 1685-1804, 1805-1933, 1934-2057, 2058-2159, 1-185, 186-349, 350-501, 502-599, 600-727, 728-851.)
G-2 Journal 1-31 October 1950
G-2 Message Files (October) (913-1602, 1603-2189)
Periodic Intelligence Reports G-34 (September)
Periodic Intelligence Reports 37-44 (October)
G-3 Journal (September - October)
Periodic Operations Reports (September - October)
Operation Orders, Letters of Instruction, Operation Directives (September - October)
G-4 Journal and Message Files (22-30 August; 1-30 September; 1-31 October).
Periodic Logistics Reports (September - October)

WAR DIARY

(CSHIS-5)

Period: 010001 Sep 50
012400 Sep 50

SECOND INFANTRY DIVISION

SECRET

Entry No	Time of Action	Authority	Action
1.	0900	G-1 Journal Entry #1	G-1 called AG (Rear) transmitting order for Division Band and 100 additional personnel to be sent forward prepared for combat. Five hundred (500) SF soldiers due into rear area in morning to be sent to Division (Forward) for disposition. (Ref: G-1 Staff Section Report)
2.	0930	Surg Report Para 4.	Request made by Lt Col Carle, Division Surgeon for helicopter evacuation to Surgeon 8th Army. Two (2) helicopters placed at disposal of Division for emergency evacuation of chest, head, and stomach wound patients. (Ref: Div Surg Report.)
3.	1300	G-1 Journal Entry #3	Provisional company from the 2d Replacement Company and Division Band arrived on ten (10) 2 1/2 ton 6x6 trucks at Division (Fwd) CP with approximately two-hundred sixty-five (265) enlisted men. Major Strom and Major Duvall in charge. Sent to occupy key points on MSR. (Ref: G-1 Staff Section Report)
4.	1800	PIR #8 Hq 2d Inf Div	Enemy operations during period: After concentration and regrouping the North Korean forces opposite the 2d Infantry Division launched a coordinated attack commencing about 2330 31 August 1950. The enemy attack extended from the right flank of the 2d Division along the NAKTONG River to the left flank of the 25th Infantry Division. In the 23d Regiment sector the enemy overran "C" Company and infiltrated behind the lines attacking mortar positions. In the 9th Regiment sector the enemy by-passed strong points getting into rear of positions. Line companies were surrounded and cut off particularly in the 9th Regiment sector. Attacks were made on CP's and supporting artillery positions. By daylight the enemy had established positions on the east bank of the NAKTONG and had been able to bring across supplies and supporting armor. During the following six (6) hours the enemy continued to reinforce his elements and push east. The 2d Ron on the Division left flank was attacked initially by an estimated hundred (100) enemy which increased to three hundred (300).

Disposition of enemy forces: Elements of the 2d, 4th 10th Rifle Divisions and the 14th Mechanized Division tentatively identified in attack. Estimated that a reinforced enemy division attacked in each of the 9th and 23d Regiment sectors.

Headquarters 10th Rifle Division, 27th and 29th Regiments of the 10th Division disposed vicinity N of OKYAE-DONG, S of SONGJONG-DONG, and E of ALLIL-DONG respectively.

SECRET

Period: 010001 Sep 50
012400 Sep 50
Time

MAR DIARY
SECOND INFANTRY DIVISION

(CSHIS-5)

SECRET

Entry of
No Action Authority

Action

Entry # 4 continued:

Elements of 19th Regiment of 14th Mechanized Division vicinity of PYONGJI-DONG.

10th Mechanized Division vicinity of SAM-NI.

Headquarters 4th Rifle Division, 16th, 17th, and 18th Regiments of the 4th Rifle Division, E of SAMGA vicinity of CECH'U-RI, SINCHON-NI, PAEYU-RI, and N of CHUKCHON-NI respectively.

Attacks of Battalion strength in direction of AN-NI with estimated four to five hundred enemy pocket E of AN-NI from site of 18th Regiment of 4th Rifle Division.

Company sized attack from vicinity of YOUNI-RI towards PUGONG-NI.

Enemy capabilities: Continue to attack along the YONGSAN-NIRYANG axis with forces presently available, estimated to be elements of three (3) divisions supported by an undetermined amount of armor.

Continue attack along the NAMTUNG River valley toward SAMHANGJIN.

Continue to attack along the CHONGDONG-CHANG-YONG axis attempting to split the Division zone and the Division MSR.

Continue to attack from HYONPUNG to envelop the Division right flank.

Continued infiltration of large groups behind our positions.

Indications are that enemy main effort is along the YONGSAN-NIRYANG axis, with a supporting attack between boundaries of the 23d and 9th Regiments up the valley toward CHANGNYONG. Strength of attack towards CHANGNYONG indicate effort to seize CHANGNYONG to split the Division front.

HYONPUNG-CHONGDO axis appears to be a secondary or diversionary effort.

Enemy can be expected to continue to attack all along the Division front, striking at weak points and gaps existing in present friendly lines. Initial assault to gain bridgehead has been successful. Enemy expected to bring more armor across NAMTUNG to support breakout attempts.

It is anticipated that the enemy will continue to attack to seize CHANGNYONG and YONGSAN, bring up reinforcements, artillery and armor, and continue infiltration behind lines to sever communications and routes of supply. (Ref: FIM File 2d Inf Div.)

WAR DIARY

(CSHIS-5)

Period: 010001 Sep 50 SECOND INFANTRY DIVISION

012400 Sep 50

Time 17

SECRET

Entry of Action Authority Action

5. 2400 FOR #90 2d Inf Div Effective as of 012400K Sep 50 there was no significant change in the composition of friendly forces. reorganization and regrouping of units while holding present defensive positions was ordered to ready elements for offensive action to regain the NAKTONG River defense line.

In the 9th and 23d Infantry sectors positions were overrun by enemy troops. Units sustained heavy casualties and badly disorganized.

In the 38th Infantry area the 1st Battalion holding some general positions in N half of sector. Left flank pulled back to gain contact with 23d Infantry (-). 3d Battalion committed in 23d Infantry (-) sector in effort to halt enemy assault and hold defense line W of YONGSAN-CHANGYONG road. The 38th Infantry boundary extended S by 3d Battalion.

All division reserves now committed to include all available technical and service personnel as well as the 2d Engineer (C) Battalion.

Division boundary: Confluence of Nam River and NAKTONG River in South to a point approximately 2500 meters N of HYONFUNG on the NAKTONG River. This N boundary extending ESE on a line through SONGJI-DONG and constituting the boundary between the 1st Cavalry and 2d Division. The Division S boundary follows N bank of the NAKTONG River in an easterly direction, through SUSAN-NI. Responsibility for the area S of this boundary delegated to 25th Infantry Division.

The Division N boundary constitutes the N boundary for the 38th Infantry. 38th Infantry S boundary commences at a point on the NAKTONG River vicinity of SADUM E to a point SE of CHAMA then NE to a point W of CHANGSAN-NI then in a general easterly direction through TOYA-RI. The S boundary of the 38th Infantry is N boundary for 23d Infantry (-), S boundary 23d Infantry and N boundary 9th Infantry on a line running from FORTINGH'ARI in generally NE direction through SIBUNI - OESU-RI - SICHON - YONGSONG-NI to point N of TOCHON-NI. The S boundary for the 9th Infantry same as Division S boundary.

Division Forward CP located in vicinity of MAUN-NI. 9th Infantry CP vicinity SIMSONG-NI. 23d Infantry (-) vicinity of KUNI-RI. 38th Infantry vicinity of HACHON-RI. 2d Division Artillery 3/4 mile NW of CHONGDAE-RI.

Fred J. Meyer
FRED J. MEYER,
Captain, Infantry,
Division Historian.

SECRET

Period: 020001 Sep 50
022400 Sep 50
Time

WAR DIARY
SECOND INFANTRY DIVISION

(CSHIS-5)

SECRET

Entry No	Action	Authority	Action
----------	--------	-----------	--------

1.	Opn O #3 2d Inf Div		Composition of friendly forces: Operation order 3 published establishing Task Organization: 2d Infantry Division (-) and 1st Marine Brigade (-) attached.
----	------------------------	--	---

The 2d Infantry Division (-) with attached 1st Marine Brigade to attack and destroy enemy E of NAKTONG River and restore original defense position along the NAKTONG River line.

9th Inf (-):

Atch: Co A, 72d Tk Bn
Btry D, 82d AAA AW Bn
TACP "BERTHA 14"

Attack NW then W to Phase line 1 in zone immediately. After being passed through by the 1st Marine Brigade maintain contact on left.

32d Inf (-):

Atch: Co C, 72d Tk Bn
Btry B, 82d AAA AW Bn
TACP "Inspire 14"

38th Inf:

Atch: Btry C, 82d AAA AW Bn
TACP "Butter14"

To hold present position on phase line 1. Preparation for attack on order.

1st Marine Brigade: Attack through present position of the 9th Infantry (-) commencing at 030800K September 1950.

72d Tk Bn (-): Operational control Brigadier General Bradley.

Atch: 2d Engr (C) Bn.

Attack at 030800K September 1950, seize objective and protect left flank of the 1st Marine Brigade.

2d Div Arty (-):

15th FA Bn (-): D/S 9th Inf (-).

37th FA Bn: D/S 32d Inf (-).

38th FA Bn: D/S 38th Inf.

503d FA Bn C/S.

82d AAA AW Bn (-): As directed by CG Division artillery.

15th FA Bn (-) and 503d FA Bn (-) will give priority of fire to 1st Marine Brigade.

Lt Col Keith will assume command of 503d and 15th FA Bns to coordinate artillery fire in southern sector.

The 503d and 15th FA Bns (-) will fire a ten minute preparation to front of 9th Infantry Advance position for 1st Marine Brigade from 030750 to 030800K.

2d ~~Regt~~ to continue to screen Division left flank.

Other units: No change.

SECRET

Period: 020001 Sep 50
022400 Sep 50
Time

WAR DIARY
SECOND INFANTRY DIVISION

(CSHS-5)

SECRET

Entry of
No Action Authority

Action

Entry #1 Continued:

Contact will be established and maintained with units to flanks. Attack beyond phase lines on Division order only. These phase lines constitute generally key terrain features. Units must adjust as dictated by terrain features.

Administrative Order 1 applicable with following exceptions:

WSF to be at 64-86; other TF Comd to report locations.

Medical Clearing Stations to be located #2 at MUAN-NI, #1 MIRYANG, #3 SONSSO-DONG.

Organizations using N MSR through CHONGDO to travel only during daylight hours and in convoy. Only exception tactical necessity. Armed guards to travel with vehicles.

Straggler Line: SUSAN-NI (1169.9-1379.2) to CR (1164.1-1385.3) to MUAN-NI (1164.1-1390.5).

Road from 1st Marine Brigade Headquarters to YONGSAN to be used exclusively by the Marines from 030300 September until released by G-4.

(Ref: Opn C and Dir File 2d Div.)

2 1800 FIR #9
2d Inf Div

Following initial penetration of Divisional positions and establishing of bridgehead across NAKTONG River, the situation appears to have stabilized throughout period. Action limited to infiltration and minor attacks. Sporadic artillery and mortar fire in area. Enemy regrouping and bringing up supplies. Tanks in bridgehead. PW interrogations indicate 3 rifle regiments and elements of 16th mechanized brigade in area of 9th Infantry. Elements of 2d rifle division reported in 23d Infantry sector and the 29th rifle regiment of the 10th division with elements of 10th mechanized division in area opposite 38th Infantry to north.

Activity in 38th Infantry zone quiet with exception of infiltration to establish road blocks on MSR. 23d Infantry enemy withdraw in face of limited counterattacks. Infiltration in rear areas. Road blocks along YONGSAN-CHANGNYONG road. Artillery and mortar fire in regimental area. 9th Infantry counterattacks forced enemy to withdraw from YONGSAN.

Enemy losses during period: PWs: 21. Casualties: 500.

Enemy capabilities: From indications YONGSAN appears as enemy immediate objective. Enemy attempting to hold high ground W of YONGSAN after having been forced to withdraw.

The CHONGDONG-CHANGNYONG axis presently being utilized as an enemy MSR and main approach into 23d Regiment zone.

SECRET

WAR DIARY

(CSMIS-5)

Period: 020001 Sep 50
022400 Sep 50
Time

SECOND INFANTRY DIVISION
SECRET

Entry of
No Action Authority

Action

Entry #2 Continued:

NAKTONG valley presently a secondary effort used primarily for infiltrating lines. This area could become point of major effort at any time.

Indications of a main attack from HYONSPUNG toward CHONGDO have not appeared but increased combat partols are evident.

Large scale employment of armor has not yet occurred armor being used chiefly for infantry support tactics.

Conclusions: Under cover of darkness enemy can renew attack at any time in efforts to retake YONGSAM and exploit initial success in direction of MIRYANG. This effort combined with continued probing for weakness in line to sever lines of supply and communication.

Disposition of enemy troops: Elements of 10th rifle division with 14th armored division, 29th regiment of 10th division, and unidentified units attacking in direction of KOCHON-DONG on HYOPCHON-CHONGDO axis. Elements 2d rifle division, with 16th mechanized or armored division and the 4th regiment of the 2d division attacking towards CHANGNYONG and MASAN-RI along the CHONGDONG-CHANGNYONG axis. Estimated two (2) companies W of CHUNGSAN-RI attacking NE direction. Enemy in force across river with line extending from HYONPUNG on right flank at a variable from 2-5 miles on east side of river to SONGJIE-RI on division left.

During period the following enemy unit identifications were tentatively made: 4th, 6th and 17th (5th?) rifle regiments of the 2d rifle division 2d engineer battalion, 2d rifle division. 3 rifle regiments (designations unknown) of the 9th rifle division. 27th and 29th rifle regiments, 10th rifle division, 25th or 26th rifle regiments, 10th rifle division. Elements of 14th and 16th mechanized or armored divisions. (Ref: PIR File 2d Inf Div.)

3 2400 FOR #84
2d Inf Div

During period no appreciable change in disposition of 38th Infantry. 23d Infantry: 1st Bn, plus G Co, moving E to establish new defensive position, hit by enemy at 080645. The 3d Bn of the 38th Infantry attached to the 23d Infantry moved W to this vicinity and combined forces destroyed the enemy in area. 1st Bn 23d Infantry ordered to hold present position and all units comprising TASK FORCE HAYNES (Brigadier General Loyal K. Haynes, 2d Division Artillery CG) ordered to move on line with 1st Bn, 23d Infantry. The 9th Infantry with 2d Engineer (C) Battalion, 15th FA Bn (-), 503d FA Bn (-) and 72d Tk Bn attached under command of Brigadier General Slaeden A. Bradley (TF Bradley) was attacked by

SECRET

Period: 020001 Sep 50
022400 Sep 50

WAR DIARY
SECOND INFANTRY DIVISION

(GSHIS-5)

SECRET

Entry
No of
 Action Authority

Entry #3 Action
Continued:

undetermined number of enemy vicinity of YONGSAN. Counterattacking TF Bradley drove W from YONGSAN towards objective, approximately 2,500 yards NW of YONGSAN. In conjunction with these operations units maintained contact and security patrolling. (Ref: FCR File 2d Inf Division)

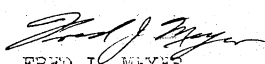
FRED J. MEYER
Captain, Infantry
Division Historian

WAR DIARY

(CSHS-5)

Period: 030001 Sep 50 SECOND INFANTRY DIVISION

032400 Sep 50

SECRET

Entry No	Time of Action	Authority	Action
1	1800	PIR #10 2d Inf Div	Enemy operations during period: Stubborn enemy resistance to attacks by 9th Infantry and 1st Marine Brigade. Enemy forced back 1500-2000 yards. In 23d Infantry sector operations remained stable. 38th Infantry holding firm. Small groups of enemy infiltrating with refugees. Enemy troops young, fatigued with inadequate supplies, morale on decline. CHANGMYONG free of enemy with exception of snipers. Enemy in hills to rear of CHANGMYONG with possible objective of severing MSR and harrassing of CHONGDO and MIRYANG. Enemy troops in many instances in possession of civilian clothes. Consolidation and resupply continuing. Localized attacks with frequent patrols. Intermittent artillery limited use of armor for screening purposes.

Enemy losses: Pws: 65. Casualties: 1200.

Enemy capabilities: Renewal of attack along YONGSAN-MIRYANG axis. Renewal of attack along CHONGDONG-CHANGMYONG axis. Envelopment of division left flank from NAKTONG River valley with available forces. Continuation of attack from HYONPUNG to envelop Division right flank. Continued infiltration of large groups behind lines, establishing road blocks and cutting lines of communication.

Reports have indicated that the enemy has been advancing under protection of white flag only to continue fighting upon approaching positions. Confirmation discovered in 23d Infantry area that enemy has been using EE 8 telephones, 81mm mortars and US carbines.

Yongsan still appears to be enemy key objective in this sector. Stubborn resistance to friendly counterattack lends weight to this supposition.

Enemy strength indications and disposition indicate that action will continue along the CHONGDONG-CHANGMYONG axis to seize CHANGMYONG. Small groups of enemy still remaining in Division rear areas strengthens the possibility of continued use of roadblocks and ambushes to sever lines of communication and supply.

NAKTONG river valley still remains as possible avenue of approach in efforts to seize MIRYANG. No present indications that this plan presently being considered by enemy.

Captured enemy documents lead to belief that the enemy may attempt an attack from the HYONPUNG sector in direction of CHANGDO and/or TAESU.

Renewal of the enemy attack can be expected at any time, in efforts to retake YONGSAN and sever lines of communications and supply, with splitting of entire divisional front.

SECRET

Period: 030001 Sep 50
032400 Sep 50

WAR DIARY
SECOND INFANTRY DIVISION

(CSHIS-5)

Time

~~SECRET~~

Entry of
No Action Authority

Action

Entry #1 Continued:

Disposition of enemy elements: Elements of 14th mechanized division, 10th rifle division, 26th and 29th regiments of the 10th rifle division in area from HYONGPUNG south to juncture with NK units vicinity of AN-NI. Elements of 16th mechanized or armored division, 2d rifle division, 4th, 6th regiments of 2d rifle division, 27th regiment of 10th rifle division, elements of 16th mechanized or armored division, 9th rifle division and 1st regiment of 9th division, disposed from vicinity of AN-NI in a southerly direction along E side of MA-TONG River in a variable line to SONGJIN closing on MSR at YONGSAN point of deepest penetration. (Ref: PIR File 2d Inf Div.)

2

G-2 Journal 1st Marine Brigade Headquarters received a 2d Inf Div message from units that the attack as ordered on 2 September 1950 commenced on schedule 0830 hours. 1st contact made with enemy in area 1/2 mile WNW of SONGNAE-RI to a point 2/5 mile SE of MYANG-NI.

Elements of the 2d Division continued to counter-attack against light to heavy resistance. Movement hampered by refugees. Friendly forces drove wedge in enemy lines in vicinity of MASUWON where E bank of the NAKTONG river was reached.

(Ref: G-2 Journal and File 2d Div)

Fred J. Memler
FRED J. MEMLER
Captain, Infantry
Division Historian

~~SECRET~~

WAR DIARY

(CSHIS-5)

Period: 040001 Sep 50
042400 Sep 50
Time

SECOND INFANTRY DIVISION

SECRET

Entry No	Action	Authority	Action
1.	1630	G-1 Journal Entry #4	Colonel Tanner, Division G-1, departed for rear echelon to arrange for receipt of 500 ROKs on 5 September 1950.
2.		Ord Journal Entry #4	Critical shortage exists for following ammunition: 57mm recoilless rifle, 105mm howitzer, 60mm mortar, 81mm mortar, 4.2 mortar, trip-flare, rocket 3.5, .45 cal cartridges.
3.	1800	PIR #11 2d Inf Div	Enemy operations during period: Enemy forces observed in vicinity of HILL 409 at 040050. Light mortar and artillery fire during day. Enemy withdrawals in 9th Regiment and 1st Marine Brigade sectors. Considerable quantities of small arms and limited number of crew-served weapons being abandoned by enemy despite apparent orderly withdrawal. Enemy resistance light stiffening as day progressed. On Division right flank enemy making orderly withdrawal in groups of 200-300 to NAKTONG. Scattered enemy armor observed in area. At 0420 A and B companies of the 38th Infantry were under attack which ceased approximately 0515. Harassment of rear areas continues.

Disposition of enemy: 25th, 27th, and 29th rifle regiments of 10th rifle division in 38th Infantry sector. 4th, 6th and 17th regiments and 2d Artillery regiment of 2d rifle division in 23d Infantry sector. 1st regiment of 9th rifle division in 9th Infantry sector. 3d Bn, 1st regiment, 9th rifle division, in 1st Marine Brigade sector.

Enemy capabilities: Defense of dominating terrain east of NAKTONG in S sector and maintenance of present positions in central and northern sectors. Withdrawal beyond NAKTONG River. Reinforcement of units presently E of NAKTONG. Counter-attack with forces locally available. Continued infiltration.

Use of mines, deployment of infantry on defensive terrain, movement of previously located troops to rear, displacement of supply and evacuation installations to rear, combined with movement of small elements to the rear from the front lines as reported by Air OP indicate possibility of planned withdrawal.

Complete withdrawal across the NAKTONG is a possibility with delaying tactics utilized to extricate men and materiel.

Present estimates place strength of enemy attack in S and Central sectors at initially two divisions with two regiments in assault with supporting armor with the possibility that reserve elements retained on W side of NAKTONG.

SECRET

Period: 040001 Sep 50
042400 Sep 50

WAR DIARY
SECOND INFANTRY DIVISION

(CSHS-5)

SECRET

- | Entry No | Time of Action | Authority | Action |
|----------|----------------|----------------------|---|
| 1. | 1630 | G-1 Journal Entry #4 | Colonel Tanner, Division G-1, departed for rear echelon to arrange for receipt of 500 ROKs on 5 September 1950. |
| 2. | | Ord Journal Entry #4 | Critical shortage exists for following ammunition: 57mm recoilless rifle, 105mm howitzer, 60mm mortar, 81mm mortar, 4.2 mortar, trip-flare, rocket 3.5, .45 cal cartridges. |

3. 1800 PIR #11
2d Inf Div
- Enemy operations during period: Enemy forces observed in vicinity of HILL 409 at 040050. Light mortar and artillery fire during day. Enemy withdrawals in 9th Regiment and 1st Marine Brigade sectors. Considerable quantities of small arms and limited number of crew-served weapons being abandoned by enemy despite apparent orderly withdrawal. Enemy resistance light stiffening as day progressed. On Division right flank enemy making orderly withdrawal in groups of 200-300 to NAKTONG. Scattered enemy armor observed in area. At 0420 A and B companies of the 38th Infantry were under attack which ceased approximately 0515. Harassment of rear areas continues.

Disposition of enemy: 25th, 27th, and 29th rifle regiments of 10th rifle division in 38th Infantry sector. 4th, 6th and 17th regiments and 2d artillery regiment of 2d rifle division in 23d Infantry sector. 1st regiment of 9th rifle division in 9th Infantry sector. 3d Bn, 1st regiment, 9th rifle division, in 1st Marine Brigade sector.

Enemy capabilities: Defense of dominating terrain east of NAKTONG in S sector and maintenance of present positions in central and northern sectors. Withdrawal beyond NAKTONG River. Reinforcement of units presently E of NAKTONG. Counter-attack with forces locally available. Continued infiltration.

Use of mines, deployment of infantry on defensive terrain, movement of previously located troops to rear, displacement of supply and evacuation installations to rear, combined with movement of small elements to the rear from the front lines as reported by Air OP indicate possibility of planned withdrawal.

Complete withdrawal across the NAKTONG is a possibility with delaying tactics utilized to extricate men and materiel.

Present estimates place strength of enemy attack in S and Central sectors at initially two divisions with two regiments in assault with supporting armor with the possibility that reserve elements retained on W side of NAKTONG.

SECRET

WAR DIARY

(CSHIS-5)

Period: 040001 Sep 50

SECOND INFANTRY DIVISION

042400 Sep 50

SECRET

Entry
No

Time

of

Action

Authority

Action

Entry #3 Continued:

If so a counter-attack with uncommitted elements is to be expected. It is possible that the enemy could counter-attack with uncommitted reserves now available E of the NAKTONG. This counter-attack might be launched in an effort to protect bridge-head and to gain time for reorganization and implementation of alternate plans.

Limited counter-attacks are to be expected in any respect along with organization of the high ground to the E of the NAKTONG for defense. This action to be combined with infiltration of small groups behind our lines.

Refugees: Refugee control in BUSAN-RI area checked by 2d CIC Det. General routes for evacuation arranged for with Korean CIC and new screening center established. Approximately 8000 refugees estimated in area to move to screening point for evacuation. (Ref: PIR File 2d Div.)

4. 2240 G-1 Journal 23d Infantry advised by radio that 500 NOKs would arrive in morning. (Ref: G-1 Staff Section Report.)
5. 2400 POR #90 No change in composition of friendly forces during period. No change in planned operations. Task Force Hayes to continue previously assigned mission. TF Bradley to continue to attack to seize phase line 2, attack to commence 050730 Sep 50. Preparatory fire 050720K to 050730K Sep 50. 1st Marine Brigade: To continue to attack to seize phase line 2. Attack to commence 050730 with ten minutes preparation by artillery.

At 040800 the 1st Marine Brigade continued attack after preliminary artillery preparation. The 3d Bn passed through the 2d Bn on this advance. Brigades advance averaged 3-4000 yards against light resistance to 1st objective. Two (2) Tks and four AT guns destroyed during period. Marine air support struck enemy targets with outstanding results. At end of period ground troops running into enemy defenses.

TF Bradley jumped off in attack at 040830 Sep 50. E, F, and G Co's attacked at same time after preliminary artillery preparation of 10 minutes. At 041230 elements of E Co on TF right flank made contact with 23d Infantry. The 2d Engineer (C) Battalion and 72d Tank Battalion (-) commanded by Colonel Sloane continued to advance against light resistance. By 1800 hours all units of TF were approaching phase line 1.

WAR DIARY

(OSRIS-5)

Period: 040001 Sep 50
042400 Sep 50

SECOND INFANTRY DIVISION

~~SECRET~~

Time
Entry of
No Action Authority

Action

Entry #5 Continued:

TF Haynes consolidating positions along Phase Line 1 in preparation for coordinated attack with adjacent units. CP of 38th Infantry attacked by an estimated 200 enemy between 1540-1730K. Two sections of A Btry, 82d AAA AW Bn dispatched to assist in destruction of enemy force. 100 casualties inflicted on enemy.

During the period 0330K to 1130K Division Artillery CP under fire from enemy 37mm AT gun. Counter-battery silenced weapon.

At 040035K Sep 50 undetermined number of enemy observed HILL 409 (1140.5-1415) carrying torches. Within short period after 040420K the enemy attacked A and B Co's of the 38th Infantry both front and rear. Attack repulsed enemy losing estimated 100 dead. (Ref: POR File, 2d Inf Div.)

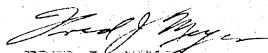

FRED J. MEYER
Captain, Infantry
Division Historian

~~SECRET~~

WAR DIARY

(CSHS-5)

Period: 050001 Sep 50
052400 Sep 50

SECOND INFANTRY DIVISION

SECRET

Entry No	Time of Action	Authority	Action
1.	0900 / 1000 / 1400	G-1 Journal Entries 7&8 & 2 of next period.	G-1 Eighth Army called for breakdown of 23d Infantry casualties. C/S flew to TF Haynes. Delivered message to 23d Infantry to expedite report. C/S directed G-1 to obt in twenty-five (25) more EM from rear echelon and take over guard of SUBAN-NI bridge with one tank dozer from 2d Engineers. (Ref: G-1 Journal Staff Section Report, 2d Div.)
2.	1800	G-1 Journal Entries 4 & 5.	100 ROKs delivered to 2d Engr (C) Co, 25 ROKs to 2d Signal Company. (Ref: G-1 Staff Section Report.)
3.	1800	FIR #12 2d Inf Div	Enemy operations during period: During evening of 4 September and enemy battalion dug in in front of the 9th Infantry on HILL 189 (1145-1190) and on the ridge running north for 2,000 yards. Night patrolling active. Artillery fire vicinity of 9th Infantry CP. Attack on G company by approximately 200 enemy. In area of the 23d Infantry enemy launched a heavy attack with estimated reinforced regiment. Principle effort on right, with moderately heavy mortar and artillery fire. The enemy using small arms, AW and artillery fire. Hill 285 still occupied by enemy with strong resistance.

Enemy losses during period: PWs: 35. Casualties: 1500.

Disposition of enemy forces: Elements 105th mechanized brigade, elements 10th rifle division, and the 29th rifle regiment of the 10th rifle division disposed area KACHOH-DONG - YUBAN-DONG. Elements 3d rifle division, 5th (17th?), 4th, 6th, and 2d artillery regiment of the 2d rifle division, with elements of the 16th mechanized or armored division, elements of 9th rifle division 1st, 2d (?), and 3d rifle regiments of the 9th rifle division disposed from vicinity of HANJH-RI in S to AN-NI in N.

Enemy capabilities. Defense of dominating terrain immediately east of the NAKTONG in the S sector and present positions in Central and N sectors. Reinforcement of units not in contact. Attack with elements not in contact. Continued infiltration of large groups behind friendly lines. Use of mines and preparation of defensive positions indicate temporary defensive measures in possible preparation for further aggressive action. Enemy continues to commit present reserves. No indication exists that enemy has been able to reinforce elements E of NAKTONG but general regrouping is evident. Enemy retains potentiality of attacking at any time with uncommitted reserves estimated at one (1) Infantry regiment each opposing the 9th and 23d sectors with establishment of strong road blocks. (Ref: FIR File 2d Inf Div.)

Period: 050001 Sep 50
052400 Sep 50

SECRET

Entry No	Time of Action	Authority	Action
----------	----------------	-----------	--------

4.	050001	Opn O 4 2d Inf Div	Enemy counter-attack with estimated reinforced regiment 23d Infantry sector apparently contained with enemy pressure continuing. Attack in S sector on 5 September moderately successful with light enemy resistance.
----	--------	-----------------------	---

Mission of Division remains same to deny enemy movement E and S of present positions to protect UN troop and supply buildup for future offensive operations. The 3d BCT, 9th Inf continues mission under army control. The 2d Infantry Division (-) to reorganize on Phase Line 1 and prepare to attack on order to destroy the enemy E of the NAKTONG River.

Task Organization:

9th Inf (-)

ATCHD: 3d Bn, 23d Inf, Co A, 72d Trk Bn, D Stry, 82d AAA AW Bn, TACP "BETHA 14", 2d Engr (C) Bn (-).

TF to organize with three battalions on line one in reserve. To attack on order. Reserve battalion not to be committed without Division order.

TF Haynes:

ATCHD: 23d Inf (-), 38th Inf, Co C, 72d Trk Bn, TACP "BUTTER 14" "INSPIRE 14".

The 23d Infantry to organize with two battalions on line and prepared to attack on order. 38th Infantry organize with 2 battalions on line one in reserve and prepared to attack on order. Reserve battalion not to be committed without Division order.

2d Reconnaissance Company to continue screening Division left flank.

72d Trk Bn (-) to remain in Division reserve vicinity TCHAM-RI.

Division Artillery: 15th FA Bn (-): Atchd: Btry C, 37th FA Bn, to render direct support to the 9th Infantry (-). Furnish artillery support to 72d Tank Bn (-). 37th FA Bn (-): In direct support of 23d Inf (-). 38th FA Bn: Direct support of 38th Infantry. 503d FA Bn: General support from present positions. 82d AAA AW Bn (-): To be employed on direction of CG Division Artillery.

Commanders directed to make necessary terrain adjustments of troops to guard approaches from NAKTONG River E to MSR. Combat outposts to be established to protect reorganization. Contact on L and R flanks to be established and maintained.

Administrative O 1 still in effect with water pts being established #1 (1164-1385), #2 (1149-1495) vicinity KONGSAM, #3 with 23d Infantry, #4 with 38th Infantry. Plan initiated as local water supplies contaminated.

SECRET

WAR DIARY

(CSHIS-5)

Period: 050001 Sep 50
052400 Sep 50

SECOND INFANTRY DIVISION

SECRET

Entry of
No. Action Authority

Action

Entry #4 Continued:

702d Ordnance directed to give priority to units in contact.

Ordnance Collection Points: Number 1 vicinity SONGSO-D ONG (1161-1411), number 2 6 miles W of YONGSAN (1151-1387), number 3 at 702d Ordnance Company located (1163-1387) 1/2 mile north of Division forward on road to Maun-Ni. Salvage to be delivered to Ordnance Collection Points.

Evacuation and hospitalization: Evacuation: Clearing Station #1 MIRYANG (1173-1393), Clearing Station #2 MUAN-NI (1164-1390), Clearing Station #3 SONGSO-DONG (1161-1411), 2d Medical Battalion evacuation by ambulance from Regimental Clearing Station to Clearing Station. Clearing Station evacuated by Medical Battalion ambulance to 8076 Mobile Army Surgical Hospital direct to railhead at MIRYANG and CHONGDO. Hospitalization to be at 8076 MASH located at MIRYANG.

Instructions covering convoy movement in CHONGDO area along N MSR to continue in effect.

(Ref: Opn C & Dir File
2d Inf Div.)

5. 1800

PIR #12
2d Inf Div

Counterintelligence: Enemy forces reported as having entered the village of CHANGNYONG after bonafide residents had passed through. In daytime NK troops appear in daylight hours in civilian clothin to escape detection from air observation. At night troops return to uniform. Concentrations of what appear to be civilians in CHANGNYONG at this time are in reality NK soldiers.

Approximately 1,000 NK troops on ridge named HWAWANG-SAN east of CHANGNYONG with heavy MGs and heavy mortars.

Interrogation of PWs establishes the fact that they are instructed to mingle with refugees from CHANGNYONG and to follow the refugee movement to MAUN-NI then to cut the MSR and move on to take MIRYANG. (REF: PIR File, 2d Inf Div.)

6. 2400

FOR #93
2d Inf Div

Composition of friendly forces. 1st Marine Brigade released from attachment to 2d Infantry Division. 3d Battalion 23d Infantry returned to control of the 2d Infantry Division. The 3d Battalion to effect relief of the 1st Marine Brigade prior to 052400.

At 050800 the 1st Marine brigade attacked w again-
st light enemy resistance the attack preceded by five (5) minutes artillery preparation. The brigade made continuous progress throughout day and approximately 051700 began consolidating positions preparatory to relief by 3d Battalion, 23d Infantry. Most advanced position from

SECRET

Period: 050001 Sep 50
052400 Sep 50

WAR DIARY
SECOND INFANTRY DIVISION

(GSHIS-5)

SECRET

Entry of
No Action Authority

Action

Entry #6 Continued:

TAEBONG-NI (1143.9-1386.8) to SONGTO-RI (1144.3-1385.0). Contact maintained with 9th Infantry on Brigade right flank. Two marine tanks knocked out by enemy tanks. Relief by 3d Battalion 23d Infantry initiated at 052000 September 1950.

9th Infantry attacked W at 050730 after ten (10) minutes artillery preparation. Moderate enemy resistance attack continued with close support with artillery and mortars. At 1000 heavy enemy resistance encountered continuing throughout attack. Most advanced position vicinity of TUGOK (1142.8-1387.3) to NU-RI (1144.0-1389.5). Contact established with 23d Infantry on right flank. 3d Battalion, 23d Infantry relieving 1st Marine Brigade attached to 9th Infantry (-) effective 051700.

2d Engineer (C) Battalion and 72d Tank Battalion (-) advanced against light resistance to position $\frac{1}{2}$ mile E of HILL 167 to position $\frac{1}{2}$ miles S of NAMJI-RI.

TF Haynes: 23d Infantry repulsed heavy enemy attacks of an estimated 3000 strength. Positions remain unchanged. 38th Infantry under light continuous enemy pressure positions unchanged.

9th Infantry (-) with 3d Battalion 23d Infantry attached, 2d Engineer (C) Battalion and 72d Tank Battalion (-) under cover of darkness withdrew to ground more easily defended along phase line 1.
(Ref: POR File, 2d Inf Div.)

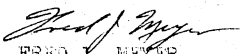
FRED J. MEYER
Captain, Infantry
Division Historian

SECRET

Period: 060001 Sep 50
062400 Sep 50

WAR DIARY
SECOND INFANTRY DIVISION

(CSHS-5)

SECRET

Entry No	Time of Action	Authority	Action
1.	1030	G-1 Journal Entry #6	375 ROKs delivered to 23d Infantry Regiment. (Ref: G-1 Staff Section Report.)
2.	1645	G-2 Journal Entry 1117	Message sent by G-2 to G3 Division Artillery concerning status of refugees in North. "Reference refugees in the North. The immediate solution will be for you to use force if necessary to turn them around or drive them back into the hills away from your immediate vicinity of your installations. We are getting 100 additional police from the home ministry who will work with the Provost Marshal and lead the refugees back out of our area. It may be tomorrow or the following day before this action can start. Reference PW's send them to CHONGDO with empty vehicles returning for rations or ammo. Turn them over to 622d Army MP's who will send them to Division PWE. We are sending two Korean interpreters to you by MP visiting patrol. (Ref: G-2 Journal and File, 2d Infantry Division.)
3.	1800	PIR #13 2d Inf Div	Enemy operations during period: Local prolings in 9th and 38th Regiment sectors. Attack launched at 0430 on 23d Infantry front by enemy with limited artillery support. By 0700 attack repulsed. Enemy withdrawasl in face of attack by 23d Infantry. Enemy troops 200 in number observed withdrawing to W of NAKTUNG. Enemy driven from HILL 285. Enemy disposition: Units previously identified: 4th, rifle regiment, 6th rifle regiment, 17th rifle regiment (?), 2d artillery regiment, 2d rifle division, 1st rifle regiment, 2d rifle regiment, and 3d rifle regiments of the 9th rifle division. Newly identified during period: 16th regiment, 4th rifle division. 1st Bn, 1st regiment, 16th mechanized brigade, signal battalion, 9th rifle division, 2d replacement company, 9th rifle division, 83d motorcycle regiment of the 105th mechanized brigade. Enemy appears to be digging in in several defensive positions in OSONG-NI ridge. As reported by the 1st Provisional Marine Brigade mine fields have been located during past two days. Enemy using 15 lb picric acid, wooden box mine with approximately 10 lbs detonation pressure required when mine is off safety and 400 lbs with safety engaged. Enemy losses during period: PWs: 8 Casualties: 1300. Enemy capabilities: Remain relatively unchanged with possible weakening of position through poor morale and high casualty rates.

Period: 060001 Sep 50

062400 Sep 50

Time

SECRET

Entry

of

No

Action Authority

Action

Entry #3 Continued:

Continued evidences of defensive measures being employed by lack of attacks and by continued improvement of defensive positions. Small unit attacks in the nature of combat patrols probing for weaknesses. Artillery fire very light. Reinforcement of enemy units has not been in evidence. However the possibility of reinforcing units under cover of darkness still remains. Infiltration continues to be reported by all friendly units.

The possibility still remains that the enemy can continue the attack at any time with an estimated reinforced regiment opposing each of regiments on line. Defense in place with a view towards probing for weakness continues to be one of enemy's objectives with efforts to cut lines of communication and destroy supporting weapons and supply installations.

Refugees: Patrols through SUSAN-NI, MIRYANG and MAUN-NI reveal small scattered groups. Thirty (3) refugees observed along road 2 miles SE of YONGSAN. 1,800 refugees in and around school house on the NE edge of YONGSAN. Total refugees in CHONGDO area: 27,600. Continued intermingling with refugees by NK soldiers still exists. Reported that NK soldiers mingle with villagers in ISDONG and CHACHON. Reports indicate that NK troops have been retaining groups of refugees under force for possible employment later as a movement screen. (Ref: PIR File 2d Infantry Division.)

4. 2025 G-2 Journal Report from G3, Division Artillery: Indicated Entry 1130 that 23d Infantry was progressing well with organization and in possession of some commanding terrain. In the 30th Infantry sector HILL 285 taken at approximately 1800. Considerable artillery buildup to front which is being worked on. (Ref: G-2 Journal & File 2d Inf Div.)
5. 2205 G-2 Journal 8-3 of Division Artillery reported on Entry 1138 requested by G-3 Colonel Holden: Friendly troops had 3 KIA, 47 WIA, 18 of wounded serious. (Ref: G-2 Journal & File 2d Inf Div.)
6. 2400 G-2 Journal Initial arrangements and requirements being made Entry 1150 to establish a raider unit. Correspondence initiated regarding formation of a force of SK, mostly police to protect the MSR from CHANGNYONG to CHONGDO. (Ref: G-2 Journal & File 2d Inf Div.)

Fred J. Meyer
 FRED J. MEYER
 Captain, Infantry
 Division Historian

SECRET

WAR DIARY

(GSHIS-5)

Period: 070001 Sep 50
072400 Sep 50

SECOND INFANTRY DIVISION

SECRET

Entry No	Time of Action	Authority	Action
1.	1215	G-2 Journal Entry 1190	<p>General Haynes reported to General Bradley that the refugee problem growing steadily worse. The combined efforts of Major Young's and General Haynes' forces presently available not sufficient to handle the problem. 3000 in vicinity of Ivory trains area (1147-1404) vicinity SUIANG and 3000 in valley (1148-1403) vicinity MAESONG-DONG, to E and S of former ASP. Villagers returning to CHANGNYONG. Approximately 200 est 2 miles S of CHANGNYONG. Road between CHANGNYONG and YONGSAN mined.</p> <p>Solution: FM working with police chief and preparing plans to solve problem. Two interpreters enroute to Division Artillery to assist in handling condition. (Ref: G-2 Journal and File 2d Infantry Division.)</p>
2.	1325	G-2 Journal Entry 1192	<p>Report received from Major Young (officer in charge of security forces) on handling of previously mentioned refugees in vicinity of Division Artillery. General Haynes contacted at 070900K and he appeared to be satisfied with situation as it existed. CHANGNYONG police were returned to city at 1000 hours by truck. Contact made with S-2 of 23d Infantry for them. CHANGNYONG police armed with 1 US LMG and 1 Russian MG and ordered to screen refugees returning home. FM contacted by Major Young on matter. Major Young assumed responsibility for refugee situation in General Haynes' sector assuring clearing of area and insuring security. (Ref: G-2 Journal and File 2d Infantry Division.)</p>
3.	1800	PIR #14 2d Inf Div	<p>Enemy operations during period: 9th Infantry Regiment outposts attacked in vicinity (1142.5-1387.0) at 1950 hours of 6th. Attack hitting left flank of 2d Battalion outpost located on road from KANG-NI to CHIRHYON-NI to S of TUGOK. At 2400 hours enemy mortar fire placed on vacated regimental outposts. Estimated enemy platoon attacked E Company in vicinity of (1144.9-1390.2) vicinity of HASINCHON. Attack reinforced reaching HILL 189 (1145.5-1384.5) NE of HASINCHON, by 1120. Left of 2d Battalion still engaged with enemy at 1800 hours. Enemy probing patrols active in 23d Regiment sector. Enemy infiltration reported and three (3) box mines laid along road S of CHANGNYONG.</p> <p>Enemy disposition: (Units in contact) Previously identified units of enemy forces in contact with elements of 2d Division: Elements of 2d rifle division, 4th, 6th, and 17th (?) rifle regiments of the 2d rifle division with artillery support from 2d artillery regiment of the 2d rifle division. Elements of 10th mechanized brigade, 10th rifle division, 16th mechanized brigade, 9th rifle division, 1st, 2d, and 3d regiments of the 9th rifle division, and the 16th regiment of the 4th rifle division. Contact reestablished with the 4th rifle division.</p>

SECRET

WAR DIARY

(CSHS-5)

Period: 070001 Sep 50
072400 Sep 50

SECOND INFANTRY DIVISION

SECRET

Entry
NoTime
of
Action Authority

Action

Entry #3 Continued:

Enemy digging in on west slope of HILL 189 and an estimated battalion digging in vicinity of HILL 165 on the high ground immediately to S.

Enemy losses: PWs: 1 Casualties: 870

Enemy capabilities remain relatively unchanged as reported on 6th. Enemy continues to improve defensive positions. Artillery fire moderate and confined to interdiction and support of small unit attacks. No indications of massing of artillery in large groups. Use of mines further indicates delaying or defensive tactics. Many reports of enemy movement behind immediate battle lines. However this movement appears to be normal supply activity along enemy MSRs with small enemy units going to and from front. No large scale reinforcements during daylight hours has been evident. Movement to W of NAKTONG indicates possible redistribution of enemy elements to other sectors of the Army front. Limited indications of attack still exist. This substantiated by continual probing of our front lines by small unit attacks. The YONGSAN and CHANGNYONG corridors remain enemy's main point of effort. Infiltration still continuing.

(Ref: PIR File, 2d Infantry Division.)

4. Staff Sec
Reports &
AG Records

Lt Col Lester W. Teter, 051512, AGC, Div AG, promoted to Colonel, paragraph 11, SO 174, DA, 7 Sep 50.

Lt Col Gerald G. Epley, 018770, GSC, Div G-2, promoted to Colonel by DA Order, paragraph 11, SO 174, 7 Sep 50.

Lt Col Donald E. Carle, 020953, MG, Div Surg, promoted to Colonel, paragraph 12, SO 174, DA, 7 Sep 50.

Lt Col Burton F. Ellis, 029053, JAGC, Div JA, promoted to Colonel, paragraph 16, SO 174, DA, 7 Sep 50.

Lt Col John G. Coughlin, 018898, Inf, asgd to 38th Inf, promoted to Colonel, paragraph 11, SO 174, DA, 7 Sep 50.

(Ref: Staff Section Reports and AG Files 2d Infantry Division.)

5. 2400

FOR #99 Composition of friendly forces remains unchanged. 2d Inf Div Planned operations include continued reorganization on Phase Line 1 in preparation for aggressive 3-2 Journal attack on order to destroy enemy E of NAKTONG R. Entry 1216 No operations ordered during period.

K Company on outpost in 9th Infantry sector under heavy enemy pressure withdrew to rear and placed in Battalion reserve while B Company 9th Infantry also on outpost withdrew as planned to better defensive positions on Phase Line 1. Enemy artillery fell in positions vacated by B Company.

(CSHIS-5)

Period: 070001 Sep 50
072400 Sep 50

WAR DIARY
SECOND INFANTRY DIVISION

SECRET

Entry of
No Action Authority

Action

Entry #5 Continued:

To counter enemy penetration on boundary between the 3d Battalion, 23d Infantry and 2d Battalion, 9th Infantry elements of 2d Battalion and K Company 23d Infantry attacking to regain position on MLR.

TF Haynes: 23d Infantry (-): 2d Battalion, G Company made limited attack to secure high ground forward of former position objective taken by 071500. 38th Inf: Little activity in 1st, 2d and 3d Battalion positions. Limited attack made at 1400 to seize remaining high ground on HILL 208 (1141.0-1405.0) at 1800 hours attack still in progress. (NOTE: 2d Division Artillery reported that limited attack initiated in 38th Infantry sector to HILL 208 as an objective was not successful and the unit (K company) returned to original positions.)

Division forward remained in vicinity of MAUN-RI.

9th Regiment CP vic of SIMBONG-DONG
23d (-) vic SINCHON-RI
1st Bn vic YONGSO-RI
2d Bn vic SONG-DONG
3d Bn 1 mi due S of MYANG-RI
38th Inf S of CHONGMYONG-RI
1st Bn vic POYONG-DONG
3d Bn 3/4 mi SW SOJI-DONG
Div Arty S of CHUNGDAE-RI

(Ref: FOR File, 2d Inf Div.)

FRED G. MEYER
Captain, Infantry
Division Historian

WAR DIARY

(CSHS-5)

Period: 080001 Sep 50
082400 Sep 50

SECOND INFANTRY DIVISION

SECRET

Entry No	Time of Action	Authority	Action
1.	1600 / 1700	C/S Journal Entires 5 and 6	General and special staff meeting 1330. No policy change. C/S to be kept informed. Visit units. Lower staff not to be asked to come to Division. All possible assistance to units. Short briefings to be conducted daily. Staff to go to CG and/or ADC through C/S. Inform C/S at once of directive by CG direct to Staff. Colonel Alfred briefed C/S on plan for defense of CP. Colonel Alfred instructed to write up memorandum on CP defense. Memorandum to be distributed throughout CP and practice defense held on 10 or 11 September. (Ref: C/S Report, 2d Inf Div.)
2.		GO 43, Hq 2d Inf Div	Lt Colonel Gerald G. Epley, 018770, GSC, Hq 2d Infantry Division, announced as C/S, vice Colonel Joseph M. Tully, 04464, GSC, relieved. Major Wallace W. Wilkins Jr., 0387709, GSC, Hq 2d Infantry Division, announced as Acting Assistant C/S, G-2, vice Lt Col Gerald G. Epley, 018770, GSC, relieved. (GO File, 2d Infantry Division.)
3.	1700	G-1 Journal Entry #3	Adjutant General reported that 500 ROKs would be delivered at 091500K Sep 50. (Ref: G-1 Staff Section Report, 2d Infantry Division.)
4.		Ord Journal Entry #8	Ammunition supply continuing critical. (Ref: Ord Staff Section Report 2d Infantry Division.)
5.	1800	FIR #15 2d Inf Div	Enemy operations during period. 3d Battalion of 23d Infantry and 38th Regiment under enemy pressure. Platoon attack commencing 0850 hours launched against the 2d Battalion of the 9th Infantry Regiment SA of TUNGSAW (1145.1-1392.0) which was repulsed. At 1100 hours an estimated enemy battalion of the 4th regiment, 2d rifle division attacked HILL 208 (1141.2-1404.5) (MURONG Mountain) forcing combat outpost of 38th Infantry Regiment to withdraw within the MLR. Simultaneously another enemy battalion of the same regiment moved into the gap of HILL 180 and was contained. Little enemy activity in 23d Infantry area. Slight penetration between A and F companies but enemy driven back out by 0730. At attack on G Company was repulsed. Enemy continues infiltration tactics. Enemy disposition: (Units in contact) Remains relatively unchanged with identification of one new unit during period 25th rifle regiment of the 10th rifle division. Enemy losses. PWs: None. Casualties: 677.

Period: 080001 Sep 50
082400 Sep 50

WAR DIARY
SECOND INFANTRY DIVISION

(CSHIS-5)

SECRET

Entry of
No Action Authority

Action

Entry #5 Continued:

Enemy capabilities remain relatively unchanged. Defense, reinforcement, attack with locally available forces, continued infiltration. Improvement of defensive positions and existing weather conditions tend towards use of battalion size attacks probing friendly defensive positions. Possibility of attack exists as denoted by continual probing of front lines especially along likely avenues of approach. Artillery has apparently registered on avenues of approach to YONGSAN and CHANGNYONG corridors and along the Division MSR between these two towns. The extent of area being held by enemy line units could indicate the inability to launch a full scale attack.

The enemy could attack at any time along the Division front with elements of three reinforced regiments capable of being reinforced by elements of three divisions (10th, 2d and 9th), supported by organic artillery and armor of a mechanized brigade. Defense can be expected to continue until regrouping, reinforcements and intelligence of our dispositions are completed.

Refugees: 20,000 refugees reported in the KUGI-RI area. Interrogation of refugees reveals claim that they were told to remain by UN Forces and upon improvement of tactical situation would be permitted to return to their homes in the CHANGNYONG - YONGSAN area.

At SUSAN-WI screening point from period 5 September through 8 September 1950 17,606 refugees screened and processed.

Enemy continuing to use wooden box mines with approximately 15.7 lbs of explosive material (probably cast TNT). Mine is of Soviet origin. In addition an improvised anti-personnel had grenade of the blast effect type being employed.

(Ref: PIR File, 2d Infantry Division)

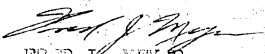
FRED J. MEYER
Captain, Infantry
Division Historian

SECRET

WAR DIARY

(CSHS-5)

Period: 090001 Sep 50
092400 Sep 50
Time

SECOND INFANTRY DIVISION

SECRET

Entry No	Time of Action	Authority	Action
1.	0830	G-1 Journal Entry #4	9th Infantry Regiment informed that 400 ROKs would be delivered at 091800K Sep 50. (Ref: G-1 Staff Section Report 2d Infantry Division.)
2.	0835	G-2 Journal Entry 1340	I Corps wants to be placed on distribution of PIR and Opn Report: Address: I Corps Rear, ATTN: G-1. Colonel Teter also requested PIR distribution be cut to copies for Finance and AG as AG holds briefings for other re r elements. (Ref: G-2 Journal and File, 2d Inf Division.)
3.	0845	G/S Log Entry #9	G-4 conferred with G/S. Has adequate ammunition with exception of 155 Howitzer. Train load due this date. 14 tanks presently in 702d Ord. 5 belonging to 23d Tk Co ready to move tanks to be held because of road conditions and conflicting traffic N-S. 5 Tks moved to Div Sig Co for radio maintenance. Tanks to be held thereafter repair in Division reserve. (Ref: G/S Report, 2d Inf Div.)
4.	0945	G/S Log Entry #10	ADC recommended amendment of current operation order to indicate no night time withdrawal from MLR positions at any time under any circumstances. Daytime withdrawals to be authorized by CG upon recommendation of regimental CO's. (Ref: G/S Report, 2d Inf Div.)
5.	1010	G/S Log Entry #12	Per instructions CG, FM to prepare control signs for traffic. FM delivered list to ADE at 1037 and was informed that signs to be available at 120800 Sep 50. (Ref: G/S Report, 2d Inf Div.)
6.	1300	G/S Log Entry #17	At 1300 CG approved plan to establish one platoon reconnaissance company with radio and wire communication to Division CP at KUGI-RI. G-2, G-3, FM, and Signal informed. Unit to be designated Ivanhoe Larson. At 100800 Major Becker to start force of 130 SMP with 5 or 6 MFs from KUGI-RI to KAM-MI. This movement to be coordinated with movement from other direction by Major Young with 50 of his force moving on KAM-RI from the west. Mission of force to destroy small groups of enemy and guerrillas encountered and gain information on larger groups. (Ref: G/S Report, 2d Inf Div.)
7.	1330	G-2 Journal Entry 1541	Effective 081330 September 1950 Colonel Apley assumed duties of G/S 2d Division vice Colonel fully evacuated because of illness. VOCC. (Ref: G/S Report, 2d Inf Div.) (G-2 Journal and File)
8.	1410	G/S Log Entry #21	Request of 2d Engineer (C) Battalion to displace Hq and Sv Company disapproved by CG. Engineers to remain present position, improving hard stands to fullest extent possible. (Ref: G/S Report, 2d Inf Div.)
9.	1500	G-2 Journal Entry 1556	CG 1st Marine Brigade requested to be dropped from routine distribution list of division to include Isums and Operation Reports. (Ref: G-2 Journal & File, 2d Infantry Division.)

SECRET

WAR DIARY

(CSHS-5)

Period: 090001 Sep 50
092400 Sep 50

SECOND INFANTRY DIVISION

SECRET

Entry No	Time of Action	Authority	Action
10.	1630	G-2 Journal Entry 1362	"Operation Larson planned for 10 September: a. Fifty (5) SK Police, under American supervision will assemble at SANGSIN'GI prior to 1000 hours, 10 September 1950. They will leave for KAM-NI at 1000 hours, 10 September 1950. b. Major Young, with fifty (50) or more men, will leave CHAKHONYOM at 1000 hours, 10 September for KAM-NI. c. Both units will meet in KAM-NI, reorganize as one unit, and then reconnoiter the hills northeast of KAM-NI to ascertain whether any Americans are being held prisoner by the Communists, and also to destroy any Guerrillas. d. Identifying signals to be used by both groups when approaching KAM-NI will be illuminating hand grenades and red air identification panels. e. One platoon from the 2d Reconnaissance Company will support the group leaving SANGSIN'GI. Their CF will be at SANGSIN'GI. This platoon to be available to support the SANGSIN'GI group if the need arises." (Ref: G-2 Journal and File, 2 Infantry Division.)
11.	1700	G/S Log Entries 25 and 26	TF Haynes reported to G/S that more hand grenades 60mm mortar shells, 155 mm illuminating shells, 155mm white bags needed. G-4 indicated that items available at Army supply point and would be supplied. TF Haynes reported Northern MSR needed repair and maintenance. Road reconnaissance to be conducted on 10 September by Engineers to provide technical supervision and hire native help to complete repairs. (Ref: G/S Report, 2d Inf Div.)
12.		Fers Periodic Report #3	During period 2-9 September losses of personnel exceeded replacements. Losses totaled 1750 including MIA and non-battle while only 350 officers and enlisted personnel were received from replacement channels and as hospital returnees. During same period 190 men carried MIA returned. 290 ROKs received during period and distributed as follows: 2d Engineer (C) Battalion 100, 23d Infantry 370, 9th Infantry 290, 2d Signal Company 25, 2d Reconnaissance Company 75, Division Headquarters (Defense Platoon) 25. This gives a total of 1540 ROKs received to date in the division. A total of 277 interments of which 248 were identified and 29 unidentified made in 2d Division cemetery at MIRYANG. Identified burials included 139 from the 2d Infantry Division and 44 from other units. Identified ROK burials totaled 16. (Ref: G-1 Staff Section Report 2d Infantry Division.)

SECRET

WAR DIARY

(CSHS-5)

Period: 090001 Sep 50

SECOND INFANTRY DIVISION

Time 092400 Sep 50

SECRET

Entry No	of Action	Authority	Action
13.	1800	PIR #16 2d Inf Div	<p>Enemy operations during period: Enemy launched a regimental attack at 082330 Sep 50 against the 23d Infantry which had been contained by 091800 Sep 50. In the 9th and 38th Infantry sectors the enemy brought up reinforcements and conducted small scale local attacks. Unsuccessful attempts made to infiltrate squad size element through L Company. In the 38th Infantry sector B Company destroyed a strong enemy road block to front. Enemy twenty-five (25) man patrol failed in attempt to penetrate to Battalion CP by flanking movements on A Company. Forty (40) enemy troops entering SAJIDONG (1141.8-1401.5) were destroyed by the 3d Battalion of the 38th Infantry.</p>

Enemy disposition: (Units in contact) No change.
No new units identified during period.

Enemy losses: PWs: 2 Casualties: 500

Enemy capabilities: Attack at any time along Division front with elements of three reinforced regiments. Reinforcement of units now in contact with elements from three divisions (10th, 2d, and 9th), with support from elements of the 16th mechanized brigade. Continued infiltration of large groups behind the friendly positions. Defense in present positions. Strongest indications are towards continuation of the enemy's offensive as period of defense, regrouping and reconnaissance are nearing completion.

(Ref: FIR File, 2d Inf Div.)

14.		GO #44, Hq 2d Inf Div	<p>1st Lt Lucian K. Truscott, III, O27518, Inf, Hq 2d Inf Div, announced as Aide-de-Camp to Major General Laurence B. Keiser, US Army.</p>
-----	--	--------------------------	--

Lt Col Ralph L. Foster, O22669, GSC, Hq 2d Inf Div announced Assistant Chief of Staff, G-2, 2d Inf Div, vice Major Wallace W. Wilkins, Jr., O387709, GSC, Hq 2d Inf Div, relieved.

(Ref: GO File, 2d Inf Div.)

Frank J. Meyer
FRANK J. MEYER
Captain, Infantry
Division Historian

SECRET

WAR DIARY

(CSHS-5)

Period: 100001 Sep 50

SECOND INFANTRY DIVISION

102400 Sep 50

SECRET

Entry No	Time of Action	Authority	Action
1.	1220	C/S Log Entry #31	Result of conference ADC and CG and consultation with Staff, the following decisions reached: 1. To send 200 ROK troops now assigned to the 9th Infantry to the 23d Infantry. 2. To send 4 Company grade officers from Re-Staff Sections to the 23d Infantry with the ROK soldiers for assignment to the 23d Infantry. 3. Have G-1 levy all service units, including Headquarters Company for 10% of their men and appropriate number of company grade officers. These to be made into a packet for assignment to Infantry Regiments, preference to 23d Infantry. (Ref: Staff Section Report, 2d Inf Div.)
2.	1530	C/S Log Entry #34	Colonel Burness, G-3 Air EUSAK, called and indicated that as of 1530 this date Division to get 34 air sorties. Division low on air priority in over-all picture. However whenever targets are picked up by requesting JOC an air strike would be forthcoming in short time. As a result of this conversation the C/S instructed G-3 Air to file daily requests for air strikes the next day. These requests to be based on G-2 and G-3 section as well as from G-3 air from the Artillery Serial and ground observers. G-3 Air to request strikes regardless of Division priority. All targets to be reported to obtain maximum air support based on available targets rather than established priorities. G-3 Air to keep record of number of written requests sent to JOC and actual number of missions flown. (Ref: Staff Section Report, G/S, 2d Inf Div.)
3.	1530	G-1 Journal Entry #4	Colonel Conley, Army G-1, visited CP and conferred with CG, ADC, and G-1, requested current strength figures. Request made for white replacements, infantry riflemen, and FA forward observers. Colonel Conley indicated that some white replacements would be furnished the Division. (Ref: G-1 Staff Section Report, 2d Infantry Division.)
4.	1800	PIR #17 2d Inf Div	Enemy operations during period: Chief activity directed towards 23d Infantry in center of Division front. Approximately two reinforced rifle regiments with supporting artillery and armor built up in this area. (Source ground and aerial observation) Explosion set off in police station in SEANGKONG at 1500 hours attributable to enemy action. Enemy continued to strengthen forces in northern sector of front to an estimated strength of one regiment. Approximately 600-800 enemy believed to have entered KONGPUNG at 1430 they were subjected to TAJ air and artillery fire. In 9th Infantry sector action confined to enemy probing and infiltration.

Enemy Disposition: (Units in Contact)

WAR DIARY

(CSHS-5)

Period: 100001 Sep 50
102400 Sep 50

SECOND INFANTRY DIVISION

SECRET

Entry of
No Action Authority

Action

Entry #4 Continued:

10th Rifle Division:
29th Regiment (1138-1415) to (1142-1418)
25th Regt (Reinf) (1142-1418) to (1141-1410)

2d Rifle Division:
4th Regiment (1141-1410) to (1140-1403)
6th Regiment (1140-1403) to (1142-1397)
5th Regiment (1142-1397) to (1144-1390)

Elms 16th Mech Brigade Supporting 2d and 9th Div.

9th Rifle Division:
Elm 1st Regiment (1144-1390) to (1145-1388)
Elm 2d Regiment (1145-1388) to (1146-1385)
Elm 3d Regiment (1146-1385) to (1147-1383)

4th Rifle Division:
Elm 16th Regiment (Reinforcing 5th Reft 2d D)
Elm 18th Regiment (1147-1383) to (1149-1383)

Total estimated enemy strength as of 10 Sep for all components of enemy facing the 2d Inf Div 26,700.

Enemy losses during period: PWs: 3 Casualties: 300.

Enemy capabilities remained relatively unchanged. General preparations for an offensive have been evident during period. Artillery has been displaced forward, troops moving into assembly areas and moving supplies and reinforcements forward. Defensive measures are still being put into effect but appear to be a temporary measure until presumed attack plans are launched. (Ref: FIR File, 2d Infantry Division.)

5. 2015 C/S Log
Entry #41 PM reported that 150 volunteer students have been set up to lead groups of refugees from vicinity of police sub-station (1161-1400) via trails and off main roads as much as possible, past MAUM-NI to SUSAM-NI. (7 actually reported)
(Ref: C/S Report, 2d Inf Div.)
6. 2100 C/S Log
Entry #42 G-1 indicated that 150 ROKs from 9th Infantry for 23d Infantry are now in the 23d Infantry trains area and will move forward in morning.
(Ref: C/S Report, 2d Inf Div.)
7. 2400 FOR #108
2d Inf Div Composition of friendly forces remains unchanged. No significant operations planned. Operations ordered continuation of aggressive patrol action.
- 9th Infantry (-) (Atchd 3d Bn, 23d Inf): Sector quiet other than enemy patrols probing line. Units still improving front line positions and laying mine fields, and barbed wire. Company G, 9th Infantry moved vicinity CHANGMONG to deny enemy use of 3 MSR.
- TF Haynes: 23d Infantry (-): General situation improved but still precarious. Company G prepared to execute attack to restore left flank of

SECRET

WAR DIARY

(GSHIS-5)

Period: 100001 Sep 50
102400 Sep 50

SECOND INFANTRY DIVISION

SECRET

Entry of
No Action Authority

Action

Entry #7 Continued:

23d Infantry if necessary. 38th Infantry:
Contact made with 27th British Brigade. Esti-
mated 100 enemy "Banzai" attack during hours
of darkness company forced to give ground. At
daylight ground retaken. K Company attacked by
undetermined number of enemy. Attack repulsed.
(Ref: FOR File, 2d Inf Div.)

8. Ord Journal 105mm and 155mm howitzer zero balance at ammuni-
Entry #18 tion supply point. (Ref: Ord Staff Section
Report, 2d Inf Div.)

Fred J. Meyer
FRED J. MEYER
Captain, Infantry
Division Historian

SECRET

WAR DIARY

(OSHS-5)

Period: 110001 Sep 50
 112400 Sep 50

SECOND INFANTRY DIVISION

SECRET

Entry No	Time of Action	Authority	Action
1.	0812	C/S Log Entry #47	G-1 informed CG and C/S that 75 men from CP Hq, QM, and Ord with available company grade officer to be sent to 23d Infantry today. (1330 20 MM fr Hq Co departed. 68 total sent forward.) (Ref: C/S Report, 2d Infantry Division.)
2.	0900	G-1 Journal Entry #7	CG-approved transfer of 20 enlisted men from forward echelon, 24 from QM and 25 from Ord Company to 23d Infantry. (Ref: G-1 Staff Section Report, 2d Inf Div.)
3.	1800	PIR #18 2d Inf Div	<p>Enemy operations during period: Enemy activity continued to be on the center and right flank of Division zone. At 110310 an estimated battalion-sized attack preceded by mortar, SF and artillery preparation which commenced at 102220 was directed at the 2d Battalion, 23d Infantry. An attack was also directed against K and L companies, 38th Infantry by an estimated battalion at 0455. Both attacks repulsed by 110720. Continued enemy buildup evident. Troops and supplies with materiel crossing NAKTONG R during hours of darkness. Continued patrol action.</p> <p>Disposition of enemy: (Units in Contact) Remains relatively unchanged. Total estimated enemy strength as of 11 September based on estimated casualties as reported by G-2, 2d Inf Div and normal attrition: 26,197.</p> <p>Eight (8) prisoners taken by 23d Infantry during period were all SK who had been conscripted by the NKPA. PWs not given weapons until they had crossed river where they were ordered to follow the troops and to take weapons and ammunition from the dead.</p> <p>No change in enemy capabilities: Attack, reinforcement, infiltration, defense of present positions, or withdrawal behind the NAKTONG at any time.</p> <p>Enemy local attacks opposite regimental boundaries could indicate efforts to determine weaknesses in defensive positions. PW reports tend to give credence to planned attack in near future to take SHANGRYONG. Continued reinforcement with build-up of supplies reported. Enemy still successfully infiltrating behind allied lines. (Ref: PIR File, 2d Inf Div.)</p>
4.		Ord Journal Entry #11	<p>Received 105mm and 155mm ammunition. Temporary relief of ammunition shortage. Restriction of twenty-five (25) rounds per gun per day - carbine in critical short supply. (Ref: Ord Staff Report, 2d Infantry Division.)</p>

Period: 110001 Sep 50
112400 Sep 50

WAR DIARY
SECOND INFANTRY DIVISION

(GSHIS-5)

SECRET

Entry of
No Action Authority

Action

5. 2400 FOR #111
2d Inf Div

Letter of instruction disseminated to units on use of check point reference overlay. All units of 2d Division directed to report position, enemy position, call for artillery fires, and air strikes utilizing check point reference overlay.

No change in composition of friendly forces. No operations planned. Operations ordered continuation of aggressive patrol activities.

9th Infantry (-) (Atchd 3d Bn, 23d Inf): General improvement of front line positions, with mines and barbed wire. Combat patrols sent out and contact made with enemy. Patrol G company sent to vicinity MYONG-NI (1151-1390) to verify refugees and enemy reported vicinity. Twenty-four enemy captured including one officer. Road block established S of CHANGNYONG in vicinity (49 12-97.2) to deny enemy use of MSR.

TF Haynes: 23d Infantry (-): Received heavy artillery and mortar fire commencing 102220I to 110400I. 0519 I attack made on G company's right flank repulsed. 38th Infantry: 0515I K and L companies' repelled enemy attack forcing enemy to withdraw to rice paddies where they were subjected to artillery and mortar fire. 0700 air strikes directed against enemy in front of K and L Companies. 70 enemy dead front of L Company and 350 dead in front of K Company. Air strikes made HILLS 208 (1141.0-1405.0) and 409. Patrols dispatched to assess results. Units continuing to consolidate and strengthen positions in sector with the use of AP mines and barbed wire.

Division Artillery: Continued close support of front line units.

Tactical air flew a total of sixty-seven (67) sorties in Division sector in front of 23d Infantry where an estimated 1500 enemy casualties were reported. Targets in 38th Infantry sector hit late afternoon; strikes made on known positions HILL 409 vicinity, positions to be hit again on 12th. (Ref: FOR File, 2d Infantry Division.)

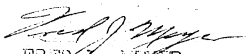
FRED J. MEYER
Captain, Infantry
Division Historian

SECRET

WAR DIARY

(CSHIS-5)

Period: 120001 Sep 50
122400 Sep 50

SECOND INFANTRY DIVISION

SECRET

Entry No	Time of Action	Authority	Action
1.	1430 / 1600 / 1900	C/S Log Entries 58, 61, and 62.	EUSAK operation order number 10 brought in by Colonel Butler, Army G-3, discussed in general terms by CG, C/S and Colonel Butler. At 1900 C/S briefed General Staff and their assistants on Opn C 10 and arrangements made for planning tent to be ready morning of 13 September and planning staff designated by C/S. (C/S Report, 2d Infantry Division.)
2.	1300	G-1 Journal Entry #2	Enlisted men approved for transfer on 11th from Headquarters, Quartermaster, and Ordnance to 23d Infantry departed for 23d.
3.	1800	PIR #19 2d Inf Div	Enemy activities confined to probing, diversionary moves, and infiltration. Enemy two platoon attack in 23d Infantry sector. Continued digging in and reinforcing of enemy along 23d Regiment front. In 38th Infantry sector enemy supplies in and around HOLPCDONG and in draw to HILL 228 (1139.0-1416.1), 0740 hours. Supplies in ox carts moving north from CHIBOL (1136.4-1419.5) at 1220 hours. 0820 hours enemy digging in at (1147.3-1413.6). Digging in at north edge of shrine (1132.4-1412.4), at 0750 hours. T-shaped trench on top of HILL 409, with number of personnel 0735. Mortars, 61mm along ridge west of HILL 409 at 0738 hours. Small group of troops and some supplies in washout 130 hours.

23d Infantry Sector: Troop concentrations on ridges (1140.2-1394.0) and (1140.3-1395.0). Reinforced platoon at (1143.2-1396.0); 100 troops at (1143.3-1397.3); 60 troops at (1142.2-1396.3), with MGs, dug in and an enemy company with mortars and MGs at (1143.9-1394.8). Because of heavy fire received by patrols the 23d Infantry considers the ridge line (1143.2-1397.4) to (1143.3-1396.5) an OPLR for next ridge back.

Enemy losses during period: PWs: 0 Casualties: 552.

Enemy potentialities remain relatively unchanged. Attack any time along Division front with main effort to right flank. Reinforce units now in contact. Continuation of infiltration tactics. Defense of present positions with forces now E of NAKTONG. Withdrawal behind NAKTONG at any time.

Indications of attack appeared to have lessened in S and central sectors but remain primary course of action on right flank. Enemy appears to be concentrating effort against the N sector of the Division front. Local attacks continue opposite regimental boundaries.

WAR DIARY

(CSHIS-5)

Period: 120001 Sep 50
122400 Sep 50

SECOND INFANTRY DIVISION

SECRET

Entry No	Time of Action	Authority	Action
4.	2400	PCR #114 2d Inf Div	Composition of friendly forces remain unchanged. No operations planned. Continued aggressive patrolling in all sectors, elimination of enemy pocket (est 200) at (1146.5-1396.4) by G Company 9th Infantry and G Company, 38th Infantry, and elimination of guerrilla groups in areas E of CHANGNYONG are ordered.

Results of operations: 9th Infantry (-): Generally quiet throughout period. Enemy patrols attempting to infiltrate through position repulsed. G Company located and took under fire 200 enemy on ridge at (1146.5-1396.4) AAA and tank fire from 23d Infantry units brought to bear on enemy to assist G Company in reducing this pocket. Final mop-up operation to be conducted by coordinated effort of G Company, 9th Infantry and G Company 38th Infantry (from the North) on 13 September. Tank and AAA supported patrol probed enemy position vicinity (1145-1384). Received MG, Mortar, and SA Fire from NAGAM, SONGTORI, and KWANDONG. Estimated one (1) company in vicinity of above three (3) towns. Enemy believed building up forces and constructing defensive positions vicinity of SONGTORI, NAGAM, and KWANDONG.

Task Force Haynes: 23d Infantry (-): 2d Battalion repulsed light attack during night 11-12 September. At 120158 enemy beat on drums and later used PA system to broadcast the voice of a woman and music. Artillery and mortar fire placed on enemy. PA system silenced. At 120715I G Company made a limited objective attack to cover advance of 1st Battalion patrols and to gain information of enemy position. Final objective taken at 120922L. Three (3) patrols 35 men each dispatched from 1st Battalion. Patrols succeeded in harassing enemy and disrupting enemy reorganization. Information obtained by above patrols is being reported through G-2 channels.

38th Infantry: Received scattered mortar and artillery fire throughout period. G Company mopped up enemy pockets in 3d Battalion sector. Estimated 72 enemy KIA: Enemy equipment including SA, mortar, AW, and AT rifles captured.

Tank supported patrol from G Company covered area (1141.30-1409.2) SW to vicinity (1138.0-1407.6) without encountering enemy. Received SA fire from vicinity (1137.9-1409.0) and observed enemy digging in vicinity (1139.5-1409.5)

Division artillery during period fired a total of 93 missions and expended 1096 rounds.

(Ref: PCR File, 2d Inf Div.)

Fred G. Meyer
FRED G. MEYER
Captain, Infantry
Division Historian

SECRET

WAR DIARY

(CSHS-5)

Period: 130001 Sep 50 SECOND INFANTRY DIVISION
 132400 Sep 50

Time

SECRET

Entry No	Time of Action	Authority	Action
1.	0900	G-1 Journal Entry #4	AG advised to assign 500 ROKs expected this date as follows: 9th Infantry 150, 23d Infantry 150, 38th Infantry 200. (Ref: G-1 Staff Section Report, 2d Inf Div.)
2.	0915	Opn Dir Hq 2d Inf Div	CG of Task Force Haynes and CO, 9th Infantry directed to initiate immediate aggressive patrols within sector of responsibility. Mission of these patrols to determine enemy troop strength, location of enemy positions, state of organization or disorganization of enemy troops, road and bridge conditions along route, bridge condition of existing bridges on MAKTONG River, destruction of small enemy groups encountered. (Ref: Opn C and Dir File, 2d Infantry Division.)
3.	1600	G-1 Journal 2d Inf Div Entry #1	500 ROKs received and disposed as indicated entry 1 above. (Ref: G-1 Staff Section Report, 2d Infantry Division.)
4.	1330 / 2000	G/S Log Entries 67 and 70	G/S directed 9th, 23d, and 38th Regiment CO's and CG Division Artillery to meet with the CG and Staff at Division CP 1700 hours, 13 September 1950. Regimental commanders briefed on preliminary plans for Opn O 10. Study and discussion following briefing. (Ref: G/S Report 2d Infantry Division.)
5.	1800	PIR #20 2d Inf Div	Enemy operations during period: Enemy activity decreased. Small enemy patrols and sporadic artillery and mortar fire along Division front. 0145 six (6) man enemy patrol penetrated position of 72d Tank Battalion. Estimated enemy battalion digging in at (1142.4-1398.0). NE of HOERYONG-NI. SF fire received by Battalion and Regimental CP areas of the 23d Infantry at 1330 and the 38th Infantry Regiment CP shelled at 1710.

Enemy capabilities remain unchanged.

Attack indications appear to be limited to right flank in HILL 409 area. 23d and 9th reported little enemy activity. Patrols encountered little enemy resistance. However enemy continues to patrol and probe lines to infiltrate into rear areas. Enemy assuming defensive attitude. Reports of digging and preparation of defensive positions becoming more numerous. Enemy troops in HILL 409 area being reinforced and receiving supplies.

It is probable that the enemy will conduct an active defense with employment of limited counterattacks coupled with withdrawal of some units from contact.

Enemy losses: PWs: 7. Casualties: 450

Disposition of enemy forces:

10th Rifle Division:
 29th Regiment(1147-1416)to(1142-1409)

SECRET

WAR DIARY

(CSHIS-5)

Period: 130001 Sep 50 SECOND INFANTRY DIVISION
132400 Sep 50

SECRET

Entry of Action Authority Action
No of Action Authority Action

Entry #5 Continued:

25th Regiment (1152-1422) to (1147-1416)

2d Rifle Division:

4th Regiment (1142-1409) to (1142-1402)

6th Regiment (1142-1402) to (1143-1393)

5th Regiment (1143-1393) to (1142-1390)

Elements of 16th mechanized brigade supporting 2d and 9th Rifle Divisions.

9th Rifle Division:

Elm 1st Regt (1143-1387) to (1143-1384)

Elm 2d Regt (1145-1382) to (1143-1381)

Elm 3d Regt (1142-1390) to (1143-1387)

4th Rifle Division:

Elm 16th Regt (Reinforcing 5th Regiment

2d Rifle Division)

Elm 18th Regt (1143-1384) to (1145-1382)

(Ref: PIR File, 2d Inf Div.)

6. 2400 FOR #117 Composition of friendly forces remains unchanged.
2d Inf Div Division operations based on implementation of
EUSAK Operation Order 10. Units to continue aggressive patrolling in all sectors. Elimination of guerrilla groups in areas E of CHANGMYONG.

9th Infantry (-): Generally quiet throughout period. At 130015I and 130200I enemy patrol unknown strength attempted infiltration in heavy mortar company position and was repulsed.

TF Haynes: 23d Infantry (-): 1st Battalion continued to improve positions, maintaining contact with enemy of undetermined strength to front. C Company cleared ridges to immediate rear and left flank of regimental position. 2d Battalion continued to improve positions and maintain contact with approximately battalion of enemy to front. 38th Infantry: Platoon of L Company cleared area behind HILL 285 (1144.5-1408.5) and rear of C company positions for snipers. No enemy troops observed; nine (9) enemy mortars (82mm) and some ammunition brought in by patrol. 3d Battalion dispatched patrol to determine results of air strike directed against NE slope of HILL 208 by four (4) F-51's.

During period in support of division operations Division Artillery fired a total of 103 missions expending 1175 rounds. (Ref: FOR File, 2d Infantry Division.)

Fred G. Mixer
FRED G. MIXER
Captain, Infantry
Division Historian

SECRET

WAR DIARY

(OSHS-5)

Period: 140001 Sep 50
142400 Sep 50

SECOND INFANTRY DIVISION

SECRET

Entry No	Time of Action	Authority	Action
1.	0645	C/S Log Entry #71	Regimental Commanders and Division Staff reviewed execution of Operation Order 10. Plan firm and Operation O to be published this date. (Ref: C/S Report, 2d Infantry Division.)
2.	0845	C/S Log Entry #72	C/S talked with Colonel Boone, Executive Officer, G-3 Section, 8th Army, reference return of 3d Battalion 9th Infantry. Colonel Boone indicated changes in Operation Order not yet received by 2d Infantry Division call for 3d Battalion to go into Army Reserve at SAMNANGJIN. Tanks presently with 3d Battalion remain attached, artillery to return to Division. (Ref: C/S Report 2d Infantry Div.)
3.	1200	Opn O #5 2d Inf. Div	On 14 September Operation Order 5 published in conjunction with Eighth Army attack plans. Eighth Army to attack from present bridgehead with main effort directed along the TAMBUN-KUMCHON-TAETON-SUWON axis. Mission to destroy enemy forces on line of advance. 3d Battalion 9th Infantry (Reinforced with Tk Company, 9th Infantry) EUSAK reserve vicinity SAMNANGJIN.

The 2d Division to attack at H-Hour D-Day to destroy enemy forces in zone of advance. LD front line positions. Advance to be coordinated with I Corps on R and 25th Div on L. D-Day 16 September 1950 H-hour to be announced later. On order Division to be prepared to cross NAM-TONG River with unlimited objective.

Composition of friendly forces:

9th Infantry (-): ATCHD: B Company, 72d Tank Battalion (Attachment effective 1512001 September 1950) D Battery, 82d AAA BN Battalion.

Relieve 3d Battalion, 23d Infantry on positions. Move to forward assembly areas. Relieve mortars and other crew-served weapons not on forward line positions daylight 14 September 1950. Relieve remainder under cover of darkness 14-15 September 1950. Attack and secure HILL 201 (C&J A) (1144-1393) by 141700 1 September 1950. Support by fire the attack of 23d Infantry on D-Day. On D-Day 9th Infantry (-) continue limited offensive action in zone.

23d Infantry: ATCHD: C Company, 72d Tank Battalion (Attachment effective 1512001 September 1950) B Battery, 82d AAA BN Battalion.

3d Battalion upon arrival, 23d Infantry zone night of 14-15 September passes to control 23d Infantry. Attacks at H-hour D-Day in zone. Objective and direction of attack SW in direction of FUGONG-I. Intermediate objectives to be as determined by Commanding Officer. Release elements 2d Battalion, 38th Infantry, upon arrival 3d Battalion, 23d Infantry.

SECRET

WAR DIARY

(CSHS-5)

Period: 140001 Sep 50
142400 Sep 50

SECOND INFANTRY DIVISION

SECRET

Entry No.	Time	Action	Authority

Action

Entry #3 Continued:

38th Infantry: ATCHD: 72d Tank Battalion (-), C Battery, 82d AAA AW Battalion:

2d Battalion will assemble in area selected by Commanding Officer, 38th Infantry by 1512001 September 1950. Protect Division right (North) flank. Attack at H-Hour D-Day in zone. Objective and direction of attack SADUNG on E bank of NAKTONG. Secure high ground E of NAKTONG and bridge site at (1134.5-1400.5) for future offensive operation (Objective C (O/L)).

Division Artillery: 15th FA Bn: D/S 9th Infantry vicinity YONGSAN (1152.3-1388.8); 37th FA Bn: D/S 23d Infantry vicinity S CHANGNYONG (1148.8-1348.7); 38th FA Bn: D/S 38th Infantry present position (1148.8-1398.7); 503d FA Bn: G/s vicinity N CHANGNYONG; 82d AAA AW Bn (-): As directed by CG 2d Division Artillery.

2d Reconnaissance Company: Relieve 2d Engineer C Battalion under cover darkness 14-15 September 1950. Protect L flank 2d Division. Coordinate advance W with 9th Infantry.

Division Security Force: (CO Major Jack P. Young) ATCHD: Elements 2d MP Company, elements 5th Korean Police Company, CHANGNYONG Police Force. Secure CHANGNYONG and immediate vicinity and clear enemy E of CHANGNYONG.

Division Reserve: 2d Engineer (C) Battalion vicinity J of YONGSAN (1150.2-1389.6).

Requests for tactical air through normal TACP. To expedite the forward advance of Division on D-Day all dominating terrain forward of present front-line positions will be occupied where-ever possible prior to D-Day. All units to be prepared to continue attack W on order.

Task Force Haynes dissolved as of 1512001 September 1950.

Division CP to move S of CHANGNYONG.

(Ref: Opn O and Dir File
2d Infantry Division.)

4. 1800 FIR #21 2d Inf Div Enemy directed efforts at containing friendly patrol activity. Artillery and mortar fire fell intermittently along entire front. Enemy patrol of 15-20 attacked I Company, 23d Infantry at 1440. Patrol of C Company, 23d Engineer (C) Battalion met enemy fire in vicinity of (1147.1-1383.3) at 0207. Enemy in undetermined strength reported by air CP in vicinity of (1143.7-1387.5) and S Company, 9th Infantry observed an estimated 75 enemy in vicinity (1143.8-1395.7). Two assault

SECRET

WAR DIARY

(GSHIS-5)

Period: 140001 Sep 50
142400 Sep 50

SECOND INFANTRY DIVISION

Time
Entry of
No Action Authority

SECRET

Action

Entry #4 Continued:

platoons of the 9th Infantry failed to dislodge an estimated enemy Battalion from HILL 201 (1144.5-1393.3). New entrenchments observed by air-OP in the 23d Infantry sector in vicinity (1144.9-1392.9) running north. At 1200 an L Company, 28th Infantry patrol pinned down by small arms fire in a village to the right front of the company sector. K Company patrol moved to vicinity of (1143.5-1403.25) encountering enemy MG fire. Patrol report indicates HILL 130 (1142-1402) and HILL 208 (1141-1404) are outposted in strength. Operation against enemy groups in rear areas continued with small isolated groups resisting stubbornly.

Indications tend towards enemy's conducting a determined defense along entire Division front. Defense of HILL 201 opposite 9th Infantry front could indicate the enemy has already adopted this plan. Possible shifting of some units to HILL 409 area with identification of all 3 Regiments of 10th Rifle Division this area could be indications of an attack from this sector. Offensive activities confined to hours of darkness.

Disposition of enemy forces:

10th Rifle Division:

29th Regiment (1151-1422) to (1143-1417)
25th Regt Reinf (1143-1417) to (1141-1410)

2d Rifle Division:

4th Regiment (1141-1410) to (1142-1402)
6th Regiment (1142-1402) to (1145-1392)
5th Regiment (1145-1392) to (1144-1389)

Elements of 16th mechanized brigade supporting 2d and 9th Rifle Divisions.

9th Rifle Division:

Elm 1st Regt (1143-1387) to (1144-1385)
Elm 2d Regt (1145-1382) to (1143-1381)
Elm 3d Regt (1144-1389) to (1143-1387)

4th Rifle Division:

Elm 16th Regt (Reinf 5th Regt, 2d Div)
Elm 18th Regt (1144-1385) to (1145-1382)

Refugees: SAN-NAM (1177.3-1381.1). Refugee screening point established 6 September 1950. As of 13 September, 10,807 refugees were screened, processed and shipped out. This in addition to the 10,000 cleared through the SUSAN-NI (1169.9-1379.0) screening point. Total refugees cleared through southern Division zone, 20,807. Refugee stream from KOGI-RI area (1161-1399) via MUAN-NI (1164.1-1390.6) to SUSAN-NI continues.

Enemy losses: PWs: 8. Casualties: 292.
(Ref: FIR File, 2d Inf Div.)

SECRET

Period: 140001 Sep 50 WAR DIARY (CSHS-5)
 142400 Sep 50 SECOND INFANTRY DIVISION

SECRET

Entry No	Time of Action	Authority	Action
----------	----------------	-----------	--------

5.	2400	FOR #120 2d Inf Div	Composition of friendly forces remains unchanged. Units are to continue aggressive patrolling in all sectors.
----	------	------------------------	---

9th Infantry (-): 0830 G Company moved from present positions and occupied HILL 125 (1144.5-1395.1) with slight opposition. At 1012I elements of F Company advanced toward HILL 201 (1144.4-1393.3) after air strike. Strong enemy resistance, unable to advance further, commenced withdrawal to original positions 1500I. Elements of B Company screened area encountering moderate to strong enemy resistance (1152-1395). Elements of A and B Companies met heavy enemy resistance in vicinity (1153-1393) fighting continually until about 1400 I when friendly forces had to withdraw to previous positions.

TF Haynes: 23d Infantry (-): 1st Battalion continuing to improve positions and extend left flank to HILL 125 (1144.5-1395.1). Patrols on left flank obtained negative results. At 132100 and at 140015I F Company repulsed two enemy patrols. 38th Infantry: An artillery concentration directed at a group of twenty (20) NVA soldiers observed moving on road toward CHADONG (43.5-15.0). 1200I, 200 ROKs dispatched to comb area E of MSR from (46-11) to (48-05). Three villages burned but no enemy observed. B Company received mortar fire from vicinity (41-13). 3d Battalion OP received three direct hits from enemy mortar at 1600. F-51's strafed and bombed NAMDONG and concentration of enemy in foxholes on SE slope HILL 409 strafed. F-80's strafed villages in front of K and L Companies. Patrols dispatched to determine results.

Division Artillery: 82d AAA AW Bn: Patrol to KAN-NI. Artillery elements fired 99 missions expending a total of 1579 rounds.

(Ref: FOR File, 2d Inf Div.)

FRED C. MEYER
Captain, Infantry
Division Historian

SECRET

WAR DIARY

(GSHIS-5)

Period: 150001 Sep 50
152400 Sep 50

SECOND INFANTRY DIVISION

Entry No	Time of Action	Authority	Action
1.	1800	FIR #22 2d Inf Div	<p>Enemy operations during period. Offensive efforts renewed against Division left and right flanks. Elements of 9th Infantry attacked 1st by an estimated enemy company at 2215. At 2230 estimated enemy battalion supported by tanks attacked the right flank of the 38th Infantry and a small group hit G Company, 23d Infantry at 2320, of 14th. An outpost of E Company, 38th Infantry froced from HILL 85 (1141.6-1406.6) by enemy of unknown strength at 0015. Heavy artillery and mortar fire preceded the majority of these attacks and fell throughout entire zone, directed at unit CPs and troop locations. Little ground gained by enemy. Enemy troop and vehicular activity increased entire zone. Enemy defensive positions being built and camouflaged on commanding terrain features. On HILLS 201 and 311 in the 9th Infantry sector connecting trenches and overhead cover being built.</p> <p>Disposition of enemy forces remains unchanged.</p> <p>Enemy attacks on Division flanks tend to confirm the belief that the enemy is making preparations for defense. The enemy continuing to improve defensive positions and these attacks acting as screen to operations as well as throwing Division elements off balance. However these attacks further indicate the enemy is capable of massing his personnel and equipment for offensive action.</p> <p>During past three days aerial observation has indicated many changes in enemy positions opposing the 9th Infantry, principally on HILLS 206, 311, 185, and 201. The most elaborate defense systems being in the HILL 201 and 311 sectors. Enemy lining positions with rock, transplanting bushes on spoil and constructing a system of communication trenches. Overhead cover has been added to some of the positions. (Probable AW emplacements, CPs or GPs.)</p> <p>Enemy losses: PWs: 3 Casualties: 372 (Ref: FIR File, 2d Inf Div.)</p>
2.	2014	G/S Log Entry #91	<p>G-3 informed G/S that tactical air support in Division sector will have priority from 0635 to 0700 16 September 1950. Deviation from this plan to be announced by EUSAK by 0400. EUSAK further stated Division to select own H-Hour. Hour for Division set at 0700 of 16th. G-3 to inform all units (confirmed by CG.) (Ref: G/S Report, 2d Inf Div.)</p>
3.	2040	G/S Log Entry #93	<p>G-3 informed G/S that an amphibious landing was made this date 0615 in vicinity of INSEON. Landing was successful and proceeding as planned. G/S directed that this information be disseminated to all units. (Ref: G/S Report, 2d Inf Div.)</p>
4.	2400	FOR #123 2d Inf Div	<p>Composition of Friendly forces: 2d Infantry Division: R: 2d Inf Div, 9th Inf (-) (3d Bn in Army Reserve) ATCAD: G Company, 72d Tk Bn,</p>

SECRET

WAR DIARY

(CSHS-5)

Period: 150001 Sep 50
152400 Sep 50

SECOND INFANTRY DIVISION

Time
Entry of
No Action Authority

Action

Entry #4 Continued:

Battery D, 82d AAA AW Battalion, TACP "BERTHA 14".

23d Infantry: ATCHD: G Company, 72d Tank Battalion, Battery B, 82d AAA AW Bn, TACP "INSPIRE 14".

38th Infantry: ATCHD: 72d Tank Battalion (-), Battery C, 82d AAA AW Bn, TACP "BUTTER 14".

Division Artillery: 15th FA Bn (D/S 9th Inf), 37th FA Bn (D/S 23d Inf), 38th FA Bn (D/S 38th Inf), 503d FA Bn (D/S 2d Div), 82d AAA AW Bn (-) (As directed by CG, Division Artillery.)

2d Reconnaissance Company
2d Engineer (C) Battalion (Division Reserve)
Division Security Force: Elements 2d MF, Elements
5th Korean Police Company, CHANGNYONG Police
Force.
Organic and Technical Service Units.

(Task Force Haynes dissolved at 151200I Sep 50.)

Results of operations: 9th Infantry: 142300I right flank E Company under attack. Company E forced to withdraw approximately 300 yards. 0500I, F Company under attack and also forced to withdraw. E and F companies reorganized and with B Company counterattacked regaining MLR position by 1100I. Company C cleared rear areas. 3d Battalion, 23d Infantry (Previously attached to 9th Infantry) relieved in position by 1st Battalion, 9th Infantry at approximately 1700I. 23d Infantry: 0415 Company C repelled light enemy attack. 3d Battalion reverted to Regimental control. Relieved by 1st Battalion 9th Infantry. Completed approximately 1700I. 38th Infantry: 1st Battalion received mortar and artillery fire throughout night 14-15 September. 142230I enemy attack Battalion strength repulsed by 2315I vicinity (1143.2-1414.5). Platoon of Company E attacked at 150015 on HILL 86 (1141.3-1406.8). Platoon forced to withdraw. Position on HILL 86 recaptured by 0900I. OP #3 (1148.2-1412.9) attacked at 0600 and forced to withdraw. OP #3 recaptured by end of period, without casualties. Division Artillery: Battery C, 15th FA Battalion returned to Division Artillery control. Artillery elements firing 63 missions total of 1187 rounds. 2d Engineer (C) Battalion: Relieve in position by 2d Reconnaissance Company and reverted to Division reserve approximately 151000I September 1950.

Division S and N boundaries remain unchanged. Boundary between 23d and 9th commences at a point (1141.5-1393) on MAKTONG then in an easterly direction N of HILL 201 - SSANGGYO mountain. Boundary between 38th and 23d in front of bridge site at (1134-1397) on MAKTONG-HOF'U - TAEDAE-RI - AIRAK - CHANGNYONG. (Ref: FOR FILE, 2d Infantry Division.)

FRANK J. BEYER, Capt., Inf., Div Hist.

WAR DIARY

(GSHIS-5)

Period: 160001 Sep 50
162400 Sep 50

SECOND INFANTRY DIVISION

Time
Entry of
No Action Authority

Action

1. 0745 C/S Log
Entry #95

Commanding General called G-5 8th Army (Colonel McLennon) and explained that the Division was forced to jump off without preplanned air support. Division was not able to get definite information that no air support would be available until 0630 and it was then too late to alter time of attack. Failure to be informed that there would be no air available in enough time to delay the hour of attack forced Division units to jump off against opposition which, it is felt, would have been neutralized had coordinated air support been available. This lack of pre-H-hour air support also resulted in the expenditure of large amounts of artillery ammunition which is in critical supply. Scotch 5 (8th Army) was urgently requested by the CG to make available to the Division increased allowances of artillery ammunition for reasons stated above. (Ref: C/S Report, 2d Infantry Division.)

2. 1900 C/S Log
Entry #103

CG asked that C/S direct all units to have tanks forward for early morning work. That all units will be instructed to secure objectives, consolidate positions, and mop up on 17 September 1950. 9th Infantry to submit plan of operation for 17 September. (Ref: C/S Report, 2d Inf Div.)

3. 1800 PIR #23
2d Inf Div

enemy operations during period: In face of Division attacks enemy took advantage of defensive positions. Unfavorable terrain enemy held fast while in areas which became untenable the enemy was forced to withdraw after moderate resistance, leaving considerable equipment and supplies. At end of period enemy forced from positions in the central sector but still holding his ground in the HILL 201 sector opposite the 9th Infantry and continued to hold the HILL 409 sector on the northern flank opposite the 36th Infantry.

The enemy having suffered considerably from initial offensive in our drive to reach the NAKTONG appears to be incapable of further defense in the central sector except west of the NAKTONG. Because of positions held on either flank the enemy is capable of limited counter-attacks against these flanks. Present status of offensive is such that it is not possible to determine as yet if enemy can launch an effective flanking counter-attack. Reports received that enemy is withdrawing west of the NAKTONG however whether this is a result of our offensive or enemy planned withdrawal cannot as yet be ascertained.

Disposition of enemy forces: At beginning of offensive enemy disposition remained essentially as reported on the 14th. However, with losses inflicted, withdrawals in central sector, and withdrawals west of the NAKTONG the mobility of the situation is such that the exact location of each unit is now an indeterminate factor. During period one new regiment identified: 27th

SECRET

WAR DIARY

(CSHS-5)

PERIOD: 160001 Sep 50 SECOND INFANTRY DIVISION
 162400 Sep 50

Entry of Action Authority Action

Entry #3 Continued:

regiment of the 10th rifle division (1139-1415).

Enemy losses: PWs: 4 Casualties: 2000.
 (Ref: PIR File, 2d Inf Div.)

4. 2130 C/S Log Division Artillery contacted and requested to have harrassing fire for night include villages behind enemy lines, especially where enemy has been sighted and those where it is likely that enemy will occupy to get out of r in.
 2d Inf Div Entry #106 (Ref: C/S Report, 2d Inf Div.)
5. 2150 C/S Log CG OK'd use of 2d Engineer Companies to go out in morning to 23d Infantry and 38th Infantry in order to clear up areas through which ammunition and ration trucks are unable to pass. Engineer B and C Companies assigned to mission.
 Entry #109 (Ref: C/S Report, 2d Inf Div.)
6. 2230 C/S Log ADG called C/S and informed him that 9th Infantry planned taking 1st Battalion out of line as 3d Battalion went in, but a recent contact with the 9th Infantry indicated his desire to take the 2d Battalion out and use the 3d Battalion to insure taking HILL 201. The plan is to take 201 with the 3d Battalion then turn S across the 1st Battalion front. (Ref: C/S Report, 2d Infantry Division.)
 Entry #110 C/S discussed this with G-3 who later reported that it was felt that 3d Battalion 9th Infantry would have to be employed to insure prompt securing of HILL 201. (Ref: C/S Report, 2d Div.)
7. 2240 C/S Log In conjunction with the CG's desire to have the 9th Infantry submit its plan of operations for the 17th the following plan was submitted and approved: (Execution to be on order of CG only.)
 Entry #111
 3d Battalion to attack to the N of first objective HILL 201, then swing SW to 2d objective about 3500 yards SW in vicinity of CHANG-YONG on to HILL 311 as third objective. Secondary attack by 1st Battalion B Company from present positions N to ground W of 1st Battalion objective. Second Objective to be HILL 165. 3d Battalion to be employed as a whole unit. 2d Battalion to stay in place to cover 3d Battalion advance. Time of attack to be 171000.
 (Ref: C/S Report, 2d Inf Div.)
8. Pers Periodic During period 9-16 September 1950 losses Report #5 totaled 787 including MIA, while only 564 replacements were received through replacement channels and hospital returnees. In addition 78 men returned from MIA to become effectives.
 500 ROKs received and assigned during period: 9th Inf 150, 23d Inf 150, 38th Inf 200. Total to date 2140.

Period: 160001 Sep 50
162400 Sep 50
Time

WAR DIARY
SECOND INFANTRY DIVISION

(CSHS-5)

SECRET

Entry
No of
Action Authority

Action

Entry #8 Continued:

Awards and decorations: During period following recommendations for decorations received by A & D board and forwarded to higher headquarters. One (1) recommended CMH, two (2) recommended DSC. Fifteen (15) Silver Stars and thirty-five (35) Bronze Stars were awarded individuals of the Division. Presently pending action by the A & D board are recommendations for one (1) CMH, eight (8) silver stars, nineteen (19) bronze stars, and five (5) air medals.

152 internments of which 137 were identified and 15 unidentified were made in the 2d Infantry Division cemetery at MIRYANG. Identified burials included 64 of the 2d Division, 7 of other US Army Organizations. 52 burials identified by name but determination of organization pending. 14 Korean soldiers buried during this period and included in total figure. (Ref: G-1 Staff Section Report, 2d Div.)

9. 2400 FOR #126
2d Inf Div

Composition of friendly forces remained unchanged.

9th Infantry: Ordered to seize HILL 201 (1144.3-1343.2) and OSONG-RI Ridge vicinity (1143.5-1386.0). 23d Infantry: To continue to seize objective "B" on E side of NAKTONG R vicinity NIGU-RI mopping up area along route of advance. Upon reaching objective be prepared to send patrols W of NAKTONG on Division order. 28th Infantry: To consolidate Division objective "C" mop-up area along route of advance and be prepared to send patrols W of NAKTONG on Division order. 2d Division Artillery: To continue to support units with priority of fire to 9th Infantry. 2d Engineer (C) Battalion Division reserve vicinity CHANGYONG (1149-1599). 2d Reconnaissance Company: Patrol S flank of 2d Division to vicinity AGOK (1143.5-1301.5). To reconnoiter and block draws running to the N without becoming engaged with enemy. Division objective C E bank of NAKTONG River in vicinity of SAGUNG.

Results of operations: E and F Companies of the 9th Infantry commenced attack on HILL 201 in conjunction with tanks at 1430 hours. Preceding attack air strikes were directed on area by four (4) F-51's. B Company after advancing about 200 yards toward the NW ran into enemy mortar fire, 75mm artillery shelling and MG fire. At 1600 E Company was in process of taking 1st objective (Knoll SE of HILL 201). Company F by 1600 had moved 3/4 way up HILL 201 from N. At 1930 HILL 201 had not yet been taken and E and F Companies joined together and withdrew to defensive positions for night preparing plans for continuation of attack at first light on 17th. Three out remainder of 9th Infantry zone aggressive probing patrols active. Forward elements, 2d Battalion, 9th Infantry arrived 9th Infantry CP 161000 September 1950.

Period: 160001 Sep 50
162400 Sep 50
Time

WAR DIARY
SECOND INFANTRY DIVISION
SECRET

(GSHIS-5)

Entry of
No Action Authority

Action
Entry #9 Continued:

23d Infantry with 1st Battalion on the left and 3d Battalion on the right commenced attack at 160700I Sep 50 with mission of driving to MARI-TONG River and securing Division Objective "B". During initial phase of attack the 23d Infantry met heavy resistance. By 1130 the 2d Battalion reported they had reached objective 2 (1396-1399 along grid line 1142). 1st Battalion reported having reached objective 1 of Battalion but were receiving intense fire from vicinity of HILL 201 to south. 1st Battalion ordered to hold positions until 9th Infantry could take HILL 201 and destroy enemy resistance. 3d Battalion ordered to continue advance to objective B. 1st Battalion, 23d Infantry reported at 1610I September 1950 enemy fire from HILL 201 had decreased and 1st Battalion continuing to advance to objective B. By 1732I September 1950 3d Battalion reported elements of Battalion as having reached objective B.

38th Infantry commenced attack at 0700I with an objective of driving to MARI-TONG River to secure Division objective "C". By 0840I September 2d Battalion had taken Regimental objective 2 and 1st Battalion approaching objective 1. (Objective 1 1401-1402 disposed generally along line from 1140.3-1141)(Objective 2 1403.5-1405 along grid line 1141). By 1510 2d Battalion had taken Regimental objective 3 (1403-1405 between grid lines 1138-1139) and advancing toward Regimental objective 5 (N segment of Division objective C). 3d Battalion at 1510 by passing Regimental objective 4 and advancing to Regimental objective 6 (S segment of Division objective C).

2d Division Artillery: Close support to attacking elements and targets of opportunity. 94 missions fired with an expenditure of 1101 rds.
(Ref: FCR File, 2d Inf Div.)

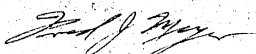
FRED J. MEYER
Captain, Infantry
Division Historian

SECRET

Period: 170001 Sep 50
172400 Sep 50

WAR DIARY
SECOND INFANTRY DIVISION

(CSHIS-5)

SECRET

Entry No	Time of Action	Authority	Action
1.	0900	Cpn Dir 2d Inf Div	Commanding Officer of 9th Infantry to continue present mission as outlined in Operation Order 17 Headquarters 9th Infantry: 9th Infantry to attack 1710001 September 1950 and destroy enemy E of NAKTONG river in zone of authority. Commanding Officer of 23d Infantry directed upon capture of HILL 201 by 9th Infantry to consolidate on position and mop-up rear area. S boundary to be changed. Assemble one (1) Battalion SW of CHANGNYONG to be committed only on Division order. Exact location to be selected and reported by CO 23d Infantry. Be prepared to attack in 9th Infantry zone and exploit 9th Infantry attack in zone. (Ref: Opn O and Dir File, 2d Infantry Division.)
2.	1000	C/S Log Entry #113	Division Artillery informed that Colonel Holden Division G-3 was at 9th Infantry and was asking for artillery support on HILL 201 with the inclusion of a plane or possible two if needed. It was indicated by the Division Artillery that everything available would be given. (Ref: C/S Report, 2d Inf Div.)
3.	1030	C/S Log Entry #115	At 1030 Division Artillery 3 informed the C/S that the 15th FA Battalion wasn't using all of the artillery it had. The 15th in touch with a liaison plane but it was difficult to determine where support needed. 15th FA Battalion indicated that they thought no support was needed at time. (Ref: C/S Report, 2d Inf Div.)
4.	1035	C/S Log Entry #116	The C/S then informed 9th Infantry that a call had been placed by Colonel Holden asking for artillery. The S-3 was further instructed to instruct personnel on how to use FO's. The 9th Infantry S-3 was then informed that Division Artillery had "a couple of batteries" standing by for use. 9th Infantry requested air and C/S indicated he would do what he could. (Ref: C/S Report, 2d Inf Div.)
5.	1100	C/S Log Entry #117	At 1100 Division Artillery called C/S indicating 15 guns ready to fire if information on targets received. (Ref: C/S Report, 2d Inf Div.)
6.	1400	G-1 Journal Entry #1	General Walton D. Walker visited CP and conferred with the Commanding General and Staff on forthcoming operations. (Ref: G-1 Staff Section Report, 2d Inf Div.)
7.	1800	PIR #24 2d Inf Div	Enemy operations during period. On central section of Division front enemy forced back across the NAKTONG River leaving quantities of arms and equipment. Enemy 2d rifle division which bore brunt of friendly offensive ceases to exist as unit East of NAKTONG. Isolated

SECRET

WAR DIARY

(CSHS-5)

Period: 1700L Sep 50
172400 Sep 50

SECOND INFANTRY DIVISION

Time
Entry of
No. Action Authority

Entry #7 Continued: Action

units and groups attempting to rejoin parent organization eliminated by air, artillery and patrol action. HILL 201 still in possession of elements of the enemy 9th rifle division. HILL 409 in N sector remains in enemy hands.

Events indicate enemy forced to withdraw W of NAKTONG. Force of friendly initial attack forced enemy to abandon quantities of supplies and equipment which made planned withdrawal impossible. Indications of enemy attempting to hold bridgeheads across NAKTONG River in vicinity of HILLS 201 and 409 evident by resistance shown by enemy in defending these key terrain features. Enemy still capable of limited counterattacks and defense of S sector. Attempts to reinforce elements E of NAKTONG are not apparent. Withdrawals to be successful must be carried out under cover of darkness. In defense of HILL 201 enemy shows disposition to counterattack when necessary. Units breaking up into small groups and moving into hills in civilian clothing. Enemy remains capable of reinforcing elements E of NAKTONG but present indications do not bear this possibility out.

It is expected that the enemy will conduct active defense employing limited aggressive counterattacks. He will in conjunction with this move withdraw W of the NAKTONG and defend with remaining elements. The possibility remains that an attack will be launched against our left flank in an effort to blunt force of friendly offensive.

Enemy losses during period: PWs: 15. Casualties: 1155.

Disposition of enemy forces:

10th Rifle Division:

27th Regiment (1142-1421) to (1143-1419)
29th Regiment (1143-1416) to (1144-1419)
25th Regiment (1139-1415)

2d Rifle Division: (1395-1402) along W

4th Regiment bank NAKTONG River.
6th Regiment
17th Regiment

16th Mechanized Brigade (1394 along W
Bank of NAKTONG River.)

9th Rifle Division:

1st Regiment
2d Regiment
3d Regiment

4th Rifle Division: (1144-1382) to (1145-1393)

16th Regiment
18th Regiment

Combat efficiency: 2d Rifle Div: est 35-40%
4th & 9th Rifle Divs:
est 50-55%

WAR DIARY

(GSHIS-5)

Period: 170001 Sep 50
172400 Sep 50
Time

SECOND INFANTRY DIVISION

Entry of
No Action Authority

Action

Entry #7 Continued:

Refugees: Road from Division CP to CHANGNYONG (1149-1399) checked. Villages burned or burning. Only 7 civilians seen. These were at CHANGNYONG. Held for police. Military police report 6,000 to 10,000 refugees about one (1) mile up valley NW of YONGSAN (1152.5-1389.5). (Ref: PIR File, 2d Infantry Division.)

8. 2200 C/S Log
Entry #118

C/S informed that pontoon bridge for crossing NAKTONG at MIRYANG and the first serial would leave 0515 morning of 18th then in successive serials 0715 and 0915. (Ref: C/S Report, 2d Infantry Division.)

9. 2400 FOR #129
2d Inf Div

Composition of friendly forces remained unchanged during period. No operations planned. 9th Infantry to continue effort to seize HILL 201 (1144.3-1393.2) and OBCNG-NI Ridge vicinity (1143.5-1386.0). Engineers were directed to reconnoiter possible bridge sites in both the 23d and 38th Infantry zones. 23d and 38th Infantry to send patrols W of NAKTONG as soon as possible on the 18th of September 1950. Contact to be established with enemy. Enemy strength and disposition to be determined. Prepare to cross river on Division Order to secure bridge sites from SA fire. Division Artillery to be prepared to support crossings.

Results of operations: 9th Infantry: 2030 16 September Company I, 3d Battalion moved from assembly area vicinity YONGSAN to B Company position. 0730 Company I commenced relief of B Company in position operation completed at 0930. At 1040I Company K on right, Company L on left crossed line of departure by passing 2d Battalion elements and attacking HILL 201. By 2000 attacking elements approximately 200 yards from topographical crest of objective. Company K and L consolidating positions in preparation for attack morning of 18 September 1950.

23d Infantry: Consolidating on Division objective in zone. Air strikes in zone during period 161800I to 161900 excellent. Air strikes on 17th directed on river.

38th Infantry: 0730 Company L and Company I continued attack and advance to river line. Division objective G reached 1040I. Other units K Company, F Company, and E Company mopping up and consolidating positions. 38th Regimental CP closed at SIBI-RI (1146.3-1403.0) and opened SINDAN-DONG (1141.9-1403.1) at 1600I.

2d Division Artillery: General relocation of elements.

WAR DIARY

(OSHS-5)

Period: 170001 Sep 50
172400 Sep 50

SECOND INFANTRY DIVISION

Time

Entry
No

Action Authority

Action

Entry #9 Continued:

A Btry, 37th FA new psn (47.50-98.63) 1200I.
 C Btry, 37th FA new psn (47.08-98.1) 1444I.
 C Btry, 38th FA new psn (42.25-03.24) 1545I.
 B Btry, 503d FA Bn new psn (44.75-00.90)0930I.

Artillery units firing on targets of opportunity in zones of attack of 2d Division units and E of NAKTONG River. Defensive or screening fire placed in front of objectives with general harrassing of enemy on both the E and W side of the NAKTONG. Missions 111 rounds expended on missions 2030. (Ref: PCR File, 2d InfDiv.)

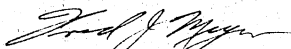

FRED J. MEYER
 Captain, Infantry
 Division Historian

WAR DIARY

(CSHS-5)

Period: 180001 Sep 50
162400 Sep 50

SECOND INFANTRY DIVISION

SECRET

Entry No	Time of Action	Authority	Action
1.	1305	C/S Log Entry #119	C/S placed call to 23d Infantry indicating planning directive being prepared for 23d Infantry to be used for planning purposes only. The plan was for 23d Infantry to hold present positions on river lightly and attack S to seize HILL 174 (1144-1391), 2d objective HILL 146 (1142-1389). At same time 9th Infantry to increase efforts. 23d Infantry to make plans and commence reconnaissance to give C/S ELD and time of attack. Plan to be executed on Division order only with possibility that attack might be ordered before dark. 23d Infantry instructed that no bridging operations would be executed without authority of Division Order. C/S approved crossing of more troops. (Ref: C/S Report, 2d Infantry Division.)
2.	1314 / 1336	C/S Log Entries 120 and 122	CG Division Artillery called C/S asking for clarification of status of 1st Battalion of the 38th Infantry, and was informed that control remained with Commanding Officer 38th Infantry until otherwise indicated. However, CG Division Artillery should be prepared to take control of 1st Battalion. CG Division Artillery informed of planning directive for 23d Infantry asking if Division Artillery could support effort. At 1336 CG Division artillery informed C/S that the following artillery available for support. From present positions 12 guns of 15th FA, 6 guns 503d and 6 guns of 37th FA. From present positions could support attack for 4-5,000 yards. By a shift of 300 mils, 3 additional batteries could also support an attack. (2 of 37th FA 1 of 503d FA Bn.) (Ref: C/S Report, 2d Infantry Div.)
3.	1320	C/S Log Entry #121	C/S authorized 38th Infantry to put one Battalion across river. (Ref: C/S Reprt, 2d Infantry Division.)
4.	1330	G-1 Journal 2d Inf Div	Al Jolson, Stage and Screen Star visited 2d Division, entertained troops of Rear Echelon and hospital patients of MIRYANG. (Ref: G-1 Staff Section Report, 2d Infantry Division.)
5.	1400	C/S Log 2d Inf Div	S-3 38th Infantry informed C/S that each Battalion sending 4 platoons across river and 1 Battalion sending an additional 2 squads. No opposition encountered. Penetration of 2000 yards. C/S inquired on possibility of forming defensive perimeter and staying night. S-3 stated he would discuss matter with Commanding Officer of 38th Infantry. Battalions in communication with elements across river. (Ref: C/S Report, 2d Infantry Division.)
6.	1447	C/S Log 2d Inf Div Entry #124	Commanding Officer of 38th Infantry placed call to C/S requesting that 1st Battalion be replaced with MP's or other troops and

SECRET

WAR DIARY
SECOND INFANTRY DIVISION

(GSHIS-5)

Period: 180001 Sep 50
182400 Sep 50

Entry of
No Action Authority Action

Entry #6 Continued:

that 1st Battalion revert to the 38th Infantry. Most of foot roops of 1 Battalion have crossed river and engineer rafts urgently needed. The river at point of crossing 100 yards wide with a depth of 10-22 feet. Cement bridge out with two spans gone and bridge badly needed to move equipment across. On far bank boats, pontoons, and canvas found out not sufficient for bridge or raft construction. Beach and road not too good. (Ref: Chief of Staff Report, 2d Inf Division.)

7. 1537 C/S Log Entry #125 C/S contacted Division Artillery 5 informing him of approval by CG of planning directive discussed earlier with the CG Division Artillery. Division Artillery 5 indicated 23d Artillery Battalion Commander would be alerted. (Ref: C/S Report, 2d Inf Div.)
8. 1549 C/S Log Entry #126 At 1549 C/S informed the Commanding Officer 23d Infantry that planning directive previously discussed earlier in afternoon had been approved but time of attack not yet set. Commanding Officer 23d Infantry felt that night attack or pre-dawn attack would not work. At this time Commanding Officer 23d Infantry expressed desire of placing 1st Battalion in position held by 2d Battalion to block possible enemy advance before moving 1st Battalion to the attack. Accomplishment of this move precluded attack prior to 0800 hours of 19th. Approval given for 23d Infantry to use own Artillery and promised efforts to supply air support. Commanding Officer 23d Infantry indicated that the rear of HILL 201 was well occupied to river and it would be necessary to take HILL 201 before attempting to take HILLS 174 and 146. (Ref: C/S Report, 2d Inf Div.)
9. 1700 C/S Log Entry #127 C/S called 23d Infantry 5 and was told that no patrols from the 23d Infantry had yet crossed the river. Patrols attempting crossings met SA, SP, and Mortar fire. Liaison officer requested of 9th Infantry by 23d Infantry to coordinate attack on 19th. Artillery fire for attack being coordinated by Division Artillery 5. 23d Infantry sending overlay of Regimental boundaries to Division Forward. Boundaries and plan being coordinated with S-3 9th Infantry. Commanding Officer of 23d Infantry felt that objective 2 limit of capacity however was informed by C/S that it might be pushed beyond that point. Commanding Officer 23d Infantry felt that it might be necessary to cut to rear of HILL 201 first. Anticipated that 1st Battalion to be in 2d Battalion position by 2100 this date. Task force composed of F Company, AAA, and Tank Platoon already in position in vicinity of line of departure. K Company to be in Regimental reserve and employed on Regimental order only. Air requested for H-40 to H-10, and artillery H-10 to H-hour. (Ref: C/S Report 2d Inf Div.)

Period: 180001 Sep-50
182400 Sep 50

WAR DIARY
SECOND INFANTRY DIVISION

(CSNIS-5)

SECRET

Entry No	Time of Action	Authority	Action
10.	1710	C/S Log Entry #128	Report received that 2d Engineer S-3 and S-5, and S-6, with Commanding Officer of 38th Infantry at NAKTONG River to select a bridge site. (Ref: C/S Report, 2d Inf Div.)
11.	1725	C/S Log Entry #129	Attack on HILL 201 continuing. 9th Infantry informed that air support being given with priority to 23d Infantry. 9th Infantry to coordinate artillery with priority given to 23d Infantry. The 9th Infantry further directed to push attack. S-5 9th Infantry estimated enemy on HILL 201 as 1 Battalion supported by another in depth. Several heavy machine guns SP, and 120mm mortars spotted. S-5 indicated attack will continue for night but C/S suggested holding present positions and saving energy for concerted effort at 0800 in morning. Further indicated that situation on HILL 201 is stubborn but no built up for an attack but feels they could attack at any time. (Ref: C/S Report, 2d Inf Div.)
12.		GO #50 Hq 2d Inf Div	565th Quartermaster Graves Registration Company, is further attached to the 2d Quartermaster Company effective 18 September 1950. (Ref: GO File, 2d Inf Div.)
13.	1800	FIR #25 2d Inf Div	Enemy operations during period. Enemy resistance in central section of Division zone continuing to weaken. Elements of 38th Infantry effected crossing of the NAKTONG River against light resistance. Enemy driven from HILL 308 (approx 2,000 yards W of river) by leading company of the 38th Infantry by end of period. Considerable quantities of supplies and equipment abandoned by enemy in withdrawal. Among the 132 prisoners captured during day by 38th Infantry, 32 were females (Nurses). From PW interrogation it was determined that only 900 personnel remained in the 2d Rifle Division. In the 23d Infantry zone of responsibility attempted crossings repelled by enemy. Regimental I & R patrols fired on while attempting river crossings in assault boats. In 9th Infantry sector enemy continues to hold HILL 201 and confines offensive action to probing patrols. Enemy mines hindered Division Reconnaissance Company advance on S flank in attempts to reach A30K. Enemy activity on flanks indicate capacity of continuing active defense in these sectors. West of NAKTONG the only indications of defense are opposite the 23d Infantry, where river crossings were repulsed. It does not appear at present that enemy intends withdrawing troops still remaining east of NAKTONG River. Only in 9th Infantry sector have reinforcements been reported as reaching the enemy, this included a small group of 20-30 personnel on HILL 201 observed by Division Air OP.

SECRET

WAR DIARY

(GSHIS-5)

Period: 180001 Sep 50
182400 Sep 50

SECOND INFANTRY DIVISION

SECRET

Entry of
No Action Authority

Action

Entry #13 Continued:

Potentiality remains for enemy to conduct active defense and employment of aggressive counterattacks. Withdrawal west of NAKTONG and defense of river line. Cr, finally, attack on left and/or right flanks of division from commanding terrain of HILLS 201 and 409.

Enemy losses: PWs: 250 (Collected not processed). Casualties: 502.

Disposition of enemy forces: As of 181600I September 1950 the enemy disposed as follows opposite 2d Infantry Division.

10th Rifle Division:

27th Regiment (1142-1421) to (1142-1417)
29th Regiment (1143-1418) to (1141-1409)
25th Regiment (1139-1415)

2d Rifle Division:

4th Regiment (1134-1407) to (1134-1403)
6th Regiment (1134-1403) to (1133-1398)
17th Regiment (1133-1398) to (1135-1395)

16th Mechanized Brigade (1394 along west bank of NAKTONG River)

9th Rifle Division:

1st Regiment (1149-1394) to (1145-1390)
2d Regiment (1138-1388)
3d Regiment (1145-1390) to (1144-1387)

4th Rifle Division: (1144-1387) to (1145-1393)
16th Regiment
18th Regiment

Combat effectiveness: 2d RD est 30%
9th RD est 50-55%
4th RD est 45-50%
(Ref: PIR File, 2d Inf Div.)

14. 2400 FOR #132
2d Inf Div

Composition of friendly forces: 2d Battalion, 9th Infantry in Army Reserve. (Company E vicinity SAMNANGJIN. 2d Battalion (-) vicinity YONGSAN, moves to vicinity SAMNANGJIN first light 19 September 1950.)

Plans include drive W toward NYONGCHON from the 38th Infantry bridgehead as soon as possible.

Results of operations: 9th Infantry (-): 3d Battalion, 9th Infantry continued attack on HILL 201 at 0620 after a six (6) minute artillery preparation. Company K attacked HILL from E, Company L from NE and Company I from NW. Attack met heavy enemy resistance. At end of period HILL 201 still in enemy hands. The 1st Battalion attack on HILL vicinity (1145-1388) stopped by MG, mortar, and SA fire and companies withdrew to original positions. OS30 elements of Service Company, Headquarters Company, and ROK Troops initiated relief of 2d Battalion on position.

SECRET

WAR DIARY

(CSHIS-5)

Period: 180001 Sep 50

SECOND INFANTRY DIVISION

182400 Sep 50

Time

Entry

of

No

Action Authority

Action

Entry #14 Continued:

23d Infantry: Company F reinforced moved vicinity (1140-1394) to cut enemy route of escape from HILL 201. In position at 1200 appears to be in control of enemy MSR for HILL 201. Lines under sporadic mortar, artillery, and high velocity fire.

38th Infantry: Continued consolidation of Division objective. Contact patrol from I Company 23d Infantry encountered approximately 150 North Koreans. Visual contact established with 23d Infantry. Patrols from 2d and 3d Battalions crossed river in zone and encountered only light resistance. Patrols followed by two (2) squads from 2d Battalion and then by one platoon. At close of period, 2d Battalion (- vehicles) W of NAKTONG vicinity (1134-1400). 1st Battalion received attack from vicinity HILL 409 at 2330, 0030, 0200, and 0500. Attacks directed at Battalion right flank and right rear. Battalion subjected to continuous artillery and mortar fire. All attacks repulsed.

2d Division Artillery: 15th FA Battalion, 37th FA Battalion, 503d FA Battalion rendered support to 9th Infantry in attacks on HILL 201. 37th FA Battalion provided covering fire for patrols along W of NAKTONG. Division Artillery fired 130 missions with expenditure of 3115 rounds. (Ref: POR File, 2d Infantry Div.)

Fred J. Meyer
 FRED J. MEYER
 Captain, Infantry
 Division Historian

WAR DIARY
SECOND INFANTRY DIVISION

(CSHIS-3)

Period: 190001 Sep 50
192400 Sep 50

Entry No	Time of Action	Authority	Action
1.	1800	G-1 Journal Entry #4	500 ROK's received and distributed 9th Infantry 250, Division Artillery 250. (Ref: G-1 Staff Section Report, 2d Infantry Division.)
2.	1800	PIR #26 2d Inf Div	<p>Enemy operations during period. Enemy resistance on HILL 201 overcome at 0845 by elements of the 9th Infantry. Enemy has well prepared delaying positions and rendering strong resistance to advance in S sector. Activity central and N sectors limited to artillery and mortar fire. Small enemy probing patrols directed at the 1st Battalion, 38th Infantry on the Division right flank and the 2d Battalion, 38th Infantry in bridgehead W of the NAKTONG River.</p> <p>Enemy capabilities remain relatively unchanged.</p> <p>Tenacious defense of successive positions in 9th Infantry sector indicates intent of holding salient. Air OP reports evidences of use of river crossing at (1137-1386) vicinity of PAKCHIN. Air observation further indicates many prepared positions W of NAKTONG thinly held. Two alternatives enemy either attempting to reinforce present positions or close existing gaps in lines. Movement not well organized or in strength. Road block reported between 1st Battalion of the 38th Infantry and the supply trains.</p> <p>Assumed that enemy will conduct active defense employing counterattacks withdrawing most of forces W of NAKTONG for defense. In conjunction with this movement attack Division right flank.</p> <p>Disposition of enemy forces remains essentially as previously reported. However fluidity of situation leads to assumption that exact determination of enemy disposition indeterminate. (Ref: PIR File, 2d Inf Div.)</p>
3.	1945 / 1952	G/S Log Entries 133 and 134	Commanding General instructed the G/S to have G-4 get request for bridging material in to HUSAK. G-4 also indicated that HUSAK very complimentary on 2d Division crossing river, breaking back of enemy, and moving the CF. G-1 informed to transmit message to all units of the compliments of the CG 8th Army. 38th Infantry to be given a special letter of commendation. (Ref: G/S Report, 2d Inf Div.)
4.	2200	G/S Log Entry #135	G-4 informed the G/S that the Army Engineer to arrive early in morning. T land at Division Artillery airstrip between 0700-0745. (Ref: G/S Report, 2d Inf Div.)

SECRET

WAR DIARY

(CSHIS-5)

Period: 190001 Sep 50
 192400 Sep 50

SECOND INFANTRY DIVISION

~~SECRET~~

Time
 Entry of
 No of Action Authority

Action

Entry #4 Continued:

Efforts being made to locate pontoons. Un-
 able to find the trucks which went after them.
 Trucks from the 60th Transportation Truck Com-
 pany which is in direct support of the Divi-
 sion. (Ref: C/S Report, 2d Inf Div.)



FRED J. MEYER
 Captain, Infantry
 Division Historian

~~SECRET~~

WAR DIARY

(CSHS-5)

Period: 200001 Sep 50
202400 Sep 50

SECOND INFANTRY DIVISION

Entry No	Time of Action	Authority	Action
1.	0800	C/S Log Entry #136	Executive Officer of 23d Infantry informed the C/S that three (3) companies were across river (I, K, & M). Executive officer 23d Infantry informed that 2d Battalion would remain in blocking position until further ordered. Commanding Officer of 23d Infantry to be at river all day. (Ref: C/S Rpt, 2d Inf Division.)
2.	1200	C/S Log Entry #137	Executive Officer 9th Infantry informed C/S that unit will make NAKTONG River today. 1st Battalion of 9th Infantry presently E of Check point 383. (Ref: C/S Report, 2d Inf Division.)
3.	1230	C/S Log Entry #138	Depending on approval of Commanding General 2d Division, Division Artillery move of CP concurred in. (Ref: C/S Report, 2d Inf Div.)
4.	1300	C/S Log Entry #139	Executive Officer 9th Infantry informed C/S that tanks have rounded HILL 206.6 and S edge of HILL 311. (Ref: C/S Report, 2d Inf Division.)
5.	1330	C/S Log Entry #140	On report from Executive Officer 9th Infantry that 2d Battalion overlooking river from W crest of HILL 311 the C/S instructed that efforts should be made to secure bridge site for river crossing. (Ref: C/S Report, 2d Infantry Division.)
6.	1345	C/S Log Entry #141	Colonel Cole stated that M-4 floating bridge did not arrive and the earliest now expected to dock PUSAN 21 September 1950. Colored engineer battalion ordered to Division area to finish construction of permanent type bridge. Matter of days before bridge can be completed. Possible to stretch present bridge equipment to make a temporary bridge by using Bailey equipment as piling, if water is not too deep. This bridge however will not accommodate M-26 Tanks. Colonel Cole returning to Pusan tonight, but will return tomorrow to orient the colored Engineer Battalion on arrival. (Ref: C/S Log Report, 2d Inf Div.)
7.	1600	C/S Log Entry #142	On receiving disposition of 9th Infantry units C/S instructed 9th Infantry to button up for night by river. 1st Battalion having seized river crossing site at 1450. (Ref: C/S Report, 2d Inf Div.)
8.	1800	FIR #27 2d Inf Div	Enemy resistance E of NAKTONG River negligible or non-existent. In S sector enemy units fought delaying action to NAKTONG River but unable to halt advance of 9th Infantry, assisted by 2d Battalion, 23d Infantry and Division Reconnaissance Company. Enemy initially resisted advance of 23d Infantry

WAR DIARY

(OSHS-5)

Period: 200001 Sep 50
202400 Sep 50

SECOND INFANTRY DIVISION

Entry of
No Action Authority

Action

Entry #8 Continued:

in crossings of NAKTONG River at 200230. By 201400 hours enemy driven off critical terrain in vicinity of HILL 227. Enemy units reported organizing positions in SINBAN-NI area. Opposite 38th Infantry enemy forces actively employing delaying tactics. Enemy patrols and mortar fire interfered with 38th Infantry in attempts to consolidate bridgehead. Enemy continues to attack small groups in rear areas. At 2130 the 82d AAA AW Bn reported receiving grenades and small arms fire from an estimated 5-6 enemy. The 66th Ordnance Maintenance Battalion attacked by an estimated 30 enemy troops during night. This unit located Division W MSR in vicinity of CHONGDO.

Enemy capabilities: Conduct an active defense, with limited counterattacks; withdrawal from present positions employing delaying tactics along main avenue of approach to NYOPCHON. Enemy can continue infiltration behind positions, establish road blocks, cut lines of communication and isolate small units.

Indications are that enemy completely disrupted by friendly offensive and is only capable of defending with limited forces and counterattacking to cover withdrawals. In S sector only unit able to hold out was Force holding HILL 201 and this primarily because of terrain advantage. Limited attacks and continued withdrawals to be expected. Infiltration always remains a possibility.

Enemy losses: PWs: 61 (54 processed).
Casualties 659.

Disposition of enemy forces: (As of 201100I September 1950.)

10th Rifle Division:

27th Regiment (1142-1431) to (1142-1417)

29th Regiment (1143-1418) to (1141-1409)

25th Regiment (1139-1415)

2d Rifle Division: Believed to be in NYOPCHON

4th Regiment

6th Regiment

17th Regiment

16th Mechanized Brigade (1130-1390)

9th Rifle Division: (1132-1385)

1st Regiment, 2d Regiment, & 3d Regiment

4th Rifle Division: (1132-1390)

15th Regiment and 18th Regiment

Combat effectiveness: 2d RD Est 15%;

9th RD Est 50%;

4th RD Est 25%;

10th RD Est 25%;

(Ref: FIR File, 2d Inf Div.)

WAR DIARY

(CSHS-5)

Period: 200001 Sep 50
202400 Sep 50

SECOND INFANTRY DIVISION

SECRET

Entry No	Time of Action	Authority	Action
9.	2000	C/S Log 2d Inf Div Entry #143	Commanding Officer 2d Engineer (C) Battalion informed that Major Zacharie in complete charge of putting NAKTONG River bridge in. "d Engineer (C) Battalion at his disposal. (Ref: C/S Report, 2d Inf Div.)
10.	2130	C/S Log 2d Inf Div Entry #144	Commanding Officer 9th Infantry Regiment informed C/S that underwater bridge existed at crossing in their area at one time but center blown out. Probable that MKs use portable treadways and pulled them out during day. (Ref: C/S Report, 2d Inf Div.)
11.	2400	Opn O 6 2d Inf Div	Operation order number 6 published: Task Organization: 9th RCT (-): Colonel C. Sloane, Commanding. ATCHD: B Co, 72d Tk Bn, B Btry, 82d AAA AW Bn, 15th FA Bn, Flat 2d Recon Company. 23d RCT: Colonel P. Freeman, Commanding. ATCHD: C Co, 72d Tk Bn (-), B Btry, 82d AAA AW Bn, 37th FA Bn. 38th RCT (-), Colonel G. B. Peplow, Commanding. ATCHD: 72d Tk Bn (-), C Btry, 82d AAA AW Bn, 38th FA Bn (-).

Eighth Army to attack from present bridgehead with main effort directed along the TAEGU (1158-1439) - KUMCHON (1110-1468) - TAEJON (1043-1494) - SUWON (1001-1609) axis, mission to destroy enemy forces on line of advance. 2d Battalion, 9th Infantry (Reinf with Tank Company, 9th Infantry) BUSAK reserve vicinity SAMHANGJIN.

2d Division ordered to attack on 21 September 1950 from present bridgehead to capture intermediate objectives and prepare to continue attack on order. Line of departure bridgehead positions. H-Hour 211200I September. Objective A (CHOGYE) B (SIBBAN-NI) C (Pt 1 1/2 miles SE of SIBBAN-NI on road from PAKCHIN to SIBBAN-NI) D (Roadjunction 1,000 yards SE of OSAN-NI) E (HYOPCHON). Two routes of attack N route commencing at 38th Infantry Bridgehead vicinity of CHUNGHOE-CHOGYE-HYOPCHON. S route commencing 1500 yards S of SADUNG on W bank of NAKTONG River 23d Infantry bridgehead and at PAKCHIN (bridgehead to be established) SIBBAN-NI - SAUM-NI - HYOPCHON.

9th RCT (-): Establish bridgehead vicinity (1137.0-1385.5) and be prepared to advance on Division Order to objectives B, D, and E. Continue flank protection for Division.

38th RCT (-): Attack with one (1) RCT, tanks attached, and capture and be prepared to advance on Division Order to CHOGYE - HYOPCHON securing the northern portion.

SECRET

Period: 200001 Sep 50
202400 Sep 50

WAR DIARY
SECOND INFANTRY DIVISION

(GSHIS-5)

Entry
No of
Action Authority

~~SECRET~~

Action

Entry #11 Continued:

2d Rcn (-): To pass through 9th RCT (-) bridgehead when established and proceed NW to point 1 1/2 miles SE of SINBAN-NI. Movement to SINBAN-NI to be coordinated with 23d RCT. Be prepared to pass through 23d RCT on order and screen division advance of main body along S route to SAUM-NI and HYOPCHON.

23d RCT: To attack from present bridgehead S with one (1) Battalion Combat Team, tanks attached, and capture SINBAN-NI. Prepared to advance on Division Order to SAUM-NI then to HYOPCHON to secure S portion.

Division Artillery: 503d FA Bn (-) render general support. Priority of fire to 38th RCT (-).

1st Bn, 38th RCT: Continue present mission. Patrol aggressively S and E slopes of HILL 409 and village of HYOPFUNG.

FA Bn attachments effective 2108001 Sep 50.

RCT's to protect respective bridgeheads from E.

Additional reconnaissance and observation instructions published:

38th Infantry: To report movement of enemy units to the rear towards possible new assembly areas, particularly vicinity of CHOGYE-NYON and HYOPCHON. Report movement along roads or avenues of approach especially along road from KARTONG River west to CHOGYE and HYOPCHON areas.

23d Infantry Regiment: To report movement of enemy units to the rear to possible assembly areas; specifically report on possible enemy assembly areas and CPs at (1133.8-1391.8), (1135.3-1392.5), (1134.2-1394.5), (1132.2-1395.3) and SINBAN-NI.

9th Infantry Regiment: To report location of enemy elements beyond which unable to advance. Report movement of enemy units to the rear; to possible assembly areas and CPs in FANGGAE-BONG valley (1134-1384) to (1134.5-1368.0) and in SINBAN-NI. Report movement along all avenues of approach from W bank of KARTONG River to the vicinity of FANGGAE-BONG (1134.5-1387.3) and SINBAN-NI.

~~SECRET~~

WAR DIARY

(CSHS-5)

Period: 20001 Sep 50
202400 Sep 50

SECOND INFANTRY DIVISION

~~SECRET~~Entry
No. Time
 of
 Action Authority

Action

Entry #11 Continued:

1st Battalion, 38th Infantry Regiment: To report location of enemy elements beyond which penetration cannot be made. Report all movement of enemy units in HYONPUNG-HILL 409 area. Report enemy CPs, assembly areas, supply routes, report all movement W beyond the NAKTONG. Attempt to determine enemy flanks, disposition and identification. Determine or estimate strength of unit opposing battalion. (Ref: Opn C and Dir File, 2d Inf Div.)



FRED J. MEYER
Captain, Infantry
Division Historian

SECRET

Period: 210001 Sep 50
212400 Sep 50

WAR DIARY
SECOND INFANTRY DIVISION

(CSHIS-5)

Entry No	Time of Action	Authority	Action
1.	1300	C/S Log Entry #147	Major Zacherle requested permission to dismantle one of Tank rafts. Raft not to be dismantled until pieces needed at approximately 1530. Permission granted by C/S. (Ref: C/S Report, 2d Inf Div.)
2.	1400	C/S Log Entry #148	Executive of 23d Infantry reported to C/S that attack progressing slowly as road pretty heavily mined. (Ref: C/S Report, 2d Inf Div.)
3.	1500	C/S Log Entry #149	Major Zacherle requested permission to use lights in order to complete bridge construction. C/S granted permission. (Ref: C/S Report, 2d Infantry Division.)
4.	1500	G-1 Journal Entry #1	Colonel Conley, Army G-1, visited CP (Fwd) on personnel matters. (Ref: G-1 Staff Section Report, 2d Inf Div.)
5.	1530	C/S Log Entry #150	All lines to 9th Infantry out. Wire chief indicated 9th Infantry takes up all lines when on move. C/S instructed SC to inform Signal Officer of 9th Infantry to have lines in whether moving or not. (Ref: C/S Report, 2d Infantry Division.)
6.	1800	PIR #28 2d Inf Div	Enemy continuing resistance to advance W of NAKTONG, River. During early morning lessening in afternoon and evening hours heavy resistance met by the 38th Infantry in its advance toward CHOGEYE. Late in day critical terrain feature overlooking CHOGEYE (HILL 239) taken and consolidated. Enemy deeply entrenched HILL 101 and fighting effective delaying action. Enemy attempted delay of 23d Infantry by holding high ground E of SINEAN-NI, by 211800 leading elements of 23d on high ground E of SINEAN-NI and tank of 23d within 1500 yards of town. Enemy used commanding terrain and good fields of fire to heavily resist attempts of 9th Infantry to establish bridgehead on W bank of NAKTONG. In HILL 409 NYONPUNG area enemy successful in halting platoon size combat patrol which was reinforced with two tanks after patrol had advanced 2000 yards. Other patrols reached objectives. One patrol entered CHOCHON and found no enemy. 1st Battalion, 38th Infantry continuing to contain enemy forces vicinity HILL 409 (NYONPUNG) area and has been placed directly under division control. Enemy's capabilities remained relatively unchanged. Active defense with counterattacks; withdrawal from present positions utilizing delaying tactics on main approach to NYONPUNG; continued infiltration behind positions to establish road blocks, cut lines of communication and isolate small units.

SECRET

WAR DIARY

(CSHS-5)

Period: 210001 Sep 50
212400 Sep 50

SECOND INFANTRY DIVISION

Entry of
No Action Authority

SECRET

Action

Entry #6 Continued:

Indications point to continued enemy defense employing limited counterattacks. Stubborn defense of approaches to CHOGYE and SINBAN-NI coupled with daylight small unit attacks point to continued use of this capability. Both the 23d and 38th Infantry reported utilization of this delaying method.

Enemy losses: PWs: 38 Casualties: 500.

Disposition of enemy was such during period that it was only possible to indicate units opposing various attacking friendly elements.

Elements of 10th, 9th, and 2d enemy divisions opposing 38th Infantry Regiments. Elements of the 4th enemy rifle division and elements of the 16th Mechanized Brigade opposing the 23d Infantry Regiment. Elements of the 4th enemy rifle division opposing the 9th Infantry Regiment. (REF: PIR File, 2d Infantry Division.)

7. 2400

POR #141
2d Inf Div

Composition of friendly forces: Task Force WOLFE: Composed of I & R Platoon, Service and Headquarters personnel, 9th RCT and ROKS. Operating as a part of 9th RCT. Mission same as 9th RCT.

1st Battalion, 38th RCT to continue aggressive patrolling and prevent enemy advance from vicinity HILL 409. 23d and 38th RCT (-) to continue attack towards HYOPCHON. 9th RCT (-) to establish bridgehead in zone west of NAKTONG River.

Results of operations: 9th RCT (-) at 1100I elements of 1st Battalion with ten (10) DUKWs initiated crossing of NAKTONG river. Despite intense enemy SA and mortar fire B Company succeeded in getting two platoons across river. C Company loaded on DUKWs preparatory to crossing NAKTONG but received heavy SA, mortar, and artillery fire. 9 of 10 DUKWs rendered non-operational. Enemy position W of river subjected to tank fire, artillery, AAA, SA, AW fire, and air strikes, but resistance continued. B Company (-) withdrew E of NAKTONG River at approximately 211800I September 1950.

23d RCT: L Company forced to withdraw from position at (1136.8-1393.3) by enemy attack of estimated company at 0905I. L Company counter-attacked regaining lost ground at 211210I. 1st Battalion 23d attacked W from NAKTONG bridgehead 1200I. Advance executed against stubborn enemy resistance.

38th RCT (-): 2d Battalion attacked SW at 211200I from NAKTONG River bridgehead. Heavy resistance from HILL 239 (1129.0-1400.5).

Period: 210001 Sep 50
212400 Sep 50

WAR DIARY
SECOND INFANTRY DIVISION

(CSHIS-5)

Entry of
No Action Authority

~~SECRET~~

Action

Entry #7 Continued:

After air strike E Company captured HILL 239 in coordinated attack. Enemy offered strong resistance from HILLS 289 (1130.6-1398.1) and 102 (1129.8-1399.6). #3 Battalion continued to protect bridgehead. 3 tanks disabled 1 AT mine two AT fire.

Division Artillery: Continued close support to RCTs in exploiting bridgeheads and river crossings.

2d Engineer Combat Battalion: Continued close direct support of RCTs. Repaired MSRs, cleared mine fields, ferried equipment and troops across NAKTONG River, constructed sandbag roadway for PUKs and continued work on pontoon bridge. (Ref: POR File, 2d Infantry Division.)

FRED J. MEYER
Captain, Infantry
Division Historian

~~SECRET~~

WAR DIARY

(USHS-5)

Period: 220001 Sep 50
222400 Sep 50

SECOND INFANTRY DIVISION

Entry No	Time of Action	Authority	Action
1.	1300	C/S Log Entry #151	Commanding General called C/S and indicated that MAKTONG bridge now in full operation and a system of priorities should be set up for use. C/S informed CG that 25d Infantry presently has priority. CG indicated need for parking area to avoid congestion at approaches. (Ref: C/S Report, 2d Inf Div.)
2.	1430	C/S Log Entry #153	General Walton Walker visited Division CP in vicinity S of CHANGKONG and discussed present tactical situation and forthcoming operations with the Commanding General 2d Division, General Laurence B. Keiser and C/S Colonel Gerald G. Epley. (Ref: C/S Report, 2d Infantry Division.)
3.	1500	Opn O 7 2d Inf Div	Because of enemy forces W of MAKTONG continuing to delay and withdraw along lines GOCGYE - HYOPCHON; SINEAN-NI - HYOPCHON, coupled with enemy held bridgehead on Division right flank (HILL 409 - HYONPENG), and strong enemy resistance continuing on Division S flank Opn O 7 published. (Ref: Opn O and Dir File, 2d Infantry Division.)
	1500	Opn O 7 2d Inf Div	9th RCT: ATCHD: 15th FA Bn, D Btry, 82d AAA AW Bn. To relieve 1st Battalion, 38th RCT on position with 2d BCT 22-23 September 1950. Mission: Block enemy movement from HILL 409. Protect Division right flank (E flank). Occupy defensive positions on E bank of MAKTONG river vicinity (1138.5-1387.8) to (1142.0-1385.0) with one (1) BCT to contain enemy and block any eastward movement in that vicinity. Relieve 3d Battalion, 38th RCT on position W of Division floating bridge. Mission: To protect bridge and bridgehead. This relief to be completed by 231600 I September 1950.
			38th RCT: ATCHD: 72d Tr Bn (- C Co), 38th FA Bn, C Btry, 82d AAA AW Bn.
			2d Reconnaissance Company: Assemble vicinity ECCHOH and be prepared to move on order.
			2d Engineer (C) Battalion: C Company: D/S 38th RCT. 2d Engineer (C) Battalion (- C Co): 3/S.
			Commanding Officer, 9th RCT to move C Company, 72d Tr Bn to dispersed area designated by Division Provost Marshal on E side of Division Bridge to arrive there by 231800I September 1950 at which time it will pass to control of Commanding Officer, 38th RCT.

WAR DIARY

(GSRHS-5)

Period: 220001 Sep 50 SECOND INFANTRY DIVISION
 222400 Sep 50

SECRET

Time
 Entry of
 No Action Authority

Action

Entry #3 Continued:

Priorities for crossing over Division floating bridge E to W only from 230001 to 231600 September 1950: 38th RCT, 3d Battalion, 9th RCT, 23d RCT. (Ref: Opn C and Dir File, 2d Infantry Division.)

4. 1800

PIR #29
2d Inf Div

Enemy operations during period: Continued delaying action along the axis CHOGYE-HYOPCHON and SINBAN-NI - HYOPCHON. Resistance continuing along Division left flank opposite 9th Infantry Regiment. Enemy conducted strong defense of CHOGYE with tanks and anti-tank defenses. Opposite 23d Infantry sector enemy counterattacked against 1st Battalion in early morning but the attack was contained by 3d Bn 23d Infantry which later reached regimental objective of SINBAN-NI at 221800. Heavy artillery and mortar fire impeded 9th Infantry efforts to establish permanent bridgehead W of NAKTONG River, however, strong patrols were able to cross river and maintain contact with enemy.

Enemy capabilities remain relatively unchanged: Indications point to withdrawal from all defensive positions immediately W of NAKTONG. Enemy employing blocking forces to screen movement of personnel and equipment. Transfer of elements in 9th Infantry Sector covered by artillery and mortars.

Enemy losses: PWs: 15 Casualties: 490.

Refugees: 18 refugees, all apprehended in various off limits areas, interrogated by agents of 2d SIG Det. 2 of villagers of KAM-NI (1155-1402), were reported to have voluntarily led NKPA infiltrators. Turned over to KA SIG.

During period total of 58 sorties, flown by 40 F-51s, 12 F-80 jets, 4 B-26 bombers and 2 F4U Corsair fighter-bombers conducted against enemy. (Ref: PIR File, 2d Inf Div.)

5. 2000

C/S Log
2d Inf Div
Entry #154

Commanding Officer, 2d Infantry called C/S informing him of plan of operations for 23 September 1950. (Ref: C/S Report, 2d Inf Division.)

6.

GO #55 Ho
2d Inf Div

1st Lt Marion H. Reid, O1C17300, Finance Corps, Headquarters 2d Infantry Division, announced as Aide-de-Camp to Major General Laurence B. Keiser, United States Army. (Ref: 2d Infantry Division.) (Ref: GO File, 2d Infantry Div.)

7.

AG Files

Captain Hunter Nelson, O420040, Infantry, promoted to Major per paragraph 8, SO CG, EUSA, 22 October 1950. Duty with division, Headquarters Commandant. (Ref: AG Officer File, 2d Infantry Division.)

SECRET

WAR DIARY

(CSHS-5)

Period: 220001 Sep 50
222400 Sep 50

SECOND INFANTRY DIVISION

Time
Entry of
No Action Authority Action

8. 2400 FOR #144 Composition of friendly forces: 2d Battalion, 9th RCT released from EUSAK control and reverted to operational control 2d Infantry Division 08001. 2d Battalion, 9th RCT closed this area 1830 I September 1950.

Results of operations: 9th RCT: At 0515 K Company moved into position vicinity of proposed 9th RCT bridge site. Withdrawal necessary because of heavy enemy mortar and artillery fire. Efforts to cross river halted and units moved back to original positions.

23d RCT: At 05001. estimated enemy battalion counterattacked against the 1st Battalion, 23d RCT. B and C Companies bore brunt of G/A and B company forced to withdraw from positions. 07301 enemy on HILLS 246 (1133-1394), 286 (1132-1393), 272 (1132-1392). During day I and F Companies sent to 1st Battalion 23d Infantry to assist in regaining lost ground, and securing N flank, prior to continuation of advance by 1st Battalion. At close of period I and B Companies had not yet taken objective. On securing HILL 286 (1132-1393) and HILL 272 (1132-1392), the 1st Battalion to hold position and prepare to continue advance on order. 2d Battalion, 23d RCT on W side of NAKTONG River at 15001. L and K Companies had advanced to (1132.5-1390.3) to (1134.4-1390.0) at 15301 and were ordered to hold. 1630 L and K Companies ordered to continue advance to high ground vicinity of SIMBAN-NI (1131-1399). SIMBAN-NI captured 18001. L and K Companies ordered to pull back to high ground overlooking SIMBAN-NI and go into defensive positions for the night.

30th RCT: 0730, G Company with Tank Company (-) jumped off for objective CHONGYE (29.5-00.5). Slight resistance encountered. G Company entered CHONGYE 12301. E and F Companies jumped off shortly after daylight to retake HILL 239 (29.0-00.5) and had retaken it by 1400. E and F Companies, with I Company in reserve made an attack on HILL 208 (27.0-01.2). HILL 208 taken 15001. One platoon, I Company and one platoon, 72d Tank Battalion (-) advanced along road to CHONGYE burning and flushing small villages. They continued to high ground NW of CHONGYE and then returned to rear.

Division Artillery: Continued to fire in close support of RCT's exploiting bridgehead W of NAKTONG River.

WAR DIARY

(CSHIS-5)

Period: 220001 Sep 50
222400 Sep 50

SECOND INFANTRY DIVISION

Entry of
No Action Authority

Action

Entry #8 Continued:

1st Battalion, 38th Regimental Combat Team relieved in position by 2d Battalion, 9th Regimental Combat Team with relief being completed by 2215 September 1950.

2d Engineer Combat Battalion: Continued close direct support to Regimental Combat Teams.
(Ref: POR File, 2d Infantry Div.)



FRED G. MEYER
Captain, Infantry
Division Historian

WAR DIARY

(CSHRIS-5)

Period: 230001 Sep 50
232400 Sep 50
Time

SECOND INFANTRY DIVISION

SECRET

Entry No	Action	Authority	Action
----------	--------	-----------	--------

1.		Ord Journal Entry #23	Ammunition continues in short supply. (Ref: Ord Staff Section Report, 2d Infantry Division.)
----	--	-----------------------	--

2.	1800	PIR #30 2d Inf Div	Enemy operations during period: Enemy resistance opposing advance of 23d and 38th Infantry Regiments decreased to light small arms and occasional artillery and mortar fire late in period. 23d Infantry seized SINGAN-RI and the 38th Infantry advanced 5,000 yards W of CHUANG. In 9th Infantry Sector enemy forces on W bank of NAKTONG on Division S flank and vicinity of HILL 409 on right flank continued to resist 9th Infantry and 1st Battalion, 38th Infantry patrol activity respectively.
----	------	-----------------------	--

Covering Force of enemy apparently penetrated. Lack of organized defense, use of heavy artillery and mortar fire or counterattack indicate enemy withdrawing to probable defensive positions to N and W of MYOCHON. Resistance to patrol activity of the 9th Infantry and elements of the 38th Infantry on both flanks of the Division indicates the enemy capability of conducting an active defense.

The 4th and 10th rifle divisions believed to be only effective enemy units to front. Elements of the 9th and 2d rifle divisions and the 16th mechanized brigade may still be to front although no PWs taken from these units in past two days.

From 0700-1805 tactical air missions were carried out. Estimated 2 companies of enemy troops strafed on road 2 miles W of SINGAN-RI. Vehicles on road W of SINGAN-RI strafed with 14 vehicles left burning. CP and CP site on HILL 668, napalmed and rocketed buildings left burning (1128-1395). Close support rendered to 38th Infantry W of CHUANG. Troops strafed on road from CHUANG to MYOCHON with one (1) enemy tank being immobilized. 25 troops napalmed and strafed N of SINGAN-RI; 1 truck and ammunition dump destroyed same vicinity. 30-40 vehicles along creek bed and road 1 to 6 miles N of MYOCHON. 3 ammunition dumps destroyed N of MYOCHON. CHUANG-RI left in flames.
(Ref: PIR File, 2d Inf Div.)

3.	Pers Periodic Report #5	Losses during period 16-23 September 1950 totaled 1324 including MIA and non-battle while only 468 replacements were received through replacement channels and hospital returnees. 5 men returned from MIA to become effectives.
----	-------------------------	--

1000 ROKs were received during the period and were assigned as follows: Division Artillery 350, 9th Infantry Regiment 250, 23d Infantry Regiment 200, 38th Infantry Regiment 200.

SECRET

Period: 230001 Sep 50
232400 Sep 50

WAR DIARY
SECOND INFANTRY DIVISION

(CSHIS-5)

Time
Entry of
No Action Authority

SECRET

Action
Entry #3 Continued:

In addition to the foregoing personnel 29 ROK officers were received and assigned proportionately to units with ROK troops, making a total of 3140 ROKs received to date in the 2d Div.

528th MI Sv Plat, furnished to the 2d Division prior to departure from Fort Lewis, Washington transferred to I Corps.

Increasing reports that the ROKs are unsatisfactory as combat soldiers. They are unwilling to fight and the infantry regiments indicate that they would rather not have them at all, in spite of a grave shortage of riflemen.

A total of 203 internments of which 171 were identified were made in the 2d Infantry Division Cemetery at MIRANG. All identified burials were members of the 2d Infantry Division, including attached ROK troops.

Awards and decorations - during the period the following recommendations were processed by the A & D board: One (1) recommended CMH, eight (8) silver stars, nineteen (19) bronze stars and five (5) air medals. Presently pending action by the board are: One (1) DSC, thirty-eight (38) silver stars, eighty (80) bronze stars, seven (7) DFCS and seventy-seven (77) air medals.
(Ref: G-1 Staff Section Report, 2d Infantry Division.)

Fred J. Meyer
FRED J. MEYER
Captain, Infantry
Division Historian

SECRET

WAR DIARY

(CSHS-5)

Period: 240001 Sep 50 SECOND INFANTRY DIVISION
 242400 Sep 50

SECRET

Entry No.	Time of Action	Authority	Action
1.	0700 / 0900	C/S Log Entry #158	Advance elements of CP moved to new location at TUGONG-NI (1131.0-1400.4). (Ref: C/S Report, 2d Infantry Division.)
2.	1130	C/S Log Entry #159	Major General James M. Gavin visited CP at CHANGNYONG conversing with the CG, C/S, and 3-3, leaving at 1300 hours. (Ref: C/S Report 2d Infantry Division.)
3.	1430	C/S Log Entry #161	Major General John B. Coulter, visited new CP site at TUGONG-NI and conversed with General Keiser. (Ref: C/S Report, 2d Inf Division.)
4.	1400	C/S Log Entry #160	Rear elements of C ₂ departed for new CP location at TUGONG-NI arriving between 1500 and 1600 hours. (Ref: C/S Report, 2d Infantry Division.)
5.	1800	PIR #31 2d Inf Div	<p>Enemy operations during period: 38th Infantry reported moderate to heavy enemy resistance. Indications 17th regiment of 4th rifle division in vicinity of HOCSON, with 2 battalions fighting and 1 battalion in reserve. 1st Battalion of enemy in vicinity of HILL 244, 1 battalion south side of river and 1 battalion in vicinity of HILL 236. Artillery fire encountered and SF fire received. Enemy abandoned considerable heavy equipment, supplies, and weapons in withdrawal to HOCSON. In 9th Infantry sector enemy still continues to offer resistance with estimated two platoons on dominating terrain W bank of HAKYONG. Enemy continuing to use sniping tactics. The 2d Battalion 9th Infantry HILL 409 area reported that enemy continued to occupy HILL 409 occasional artillery, mortar and RF fire. Enemy patrols active in area. Enemy employed machine gun equipped with an electrical control for remote operation.</p> <p>Enemy capabilities remain relatively unchanged. Delaying tactics on main avenues of approach; conduct of active defense with limited counterattacks; continued infiltration to establish road blocks and cut lines of communication.</p> <p>Enemy losses: PIR 12 Casualties: Unknown</p> <p>Disposition of enemy forces and strength indeterminate because enemy's hasty withdrawals and breaking of contact with main elements.</p> <p>During period TAC Air flew total of 66 sorties in 2d Division zone striking at SAMBA, troops and supplies NW of SIMBAK-NI (1113-1406), destruction of vehicles 5 miles N of SIMBAK-NI, destruction of tank, 5 miles N of HOCSON, and flying close support missions for 23d and 38th Infantry during day. At 1600 napalm dropped on town of ROCHANG and troops strafed on road from ROCHANG to HOCSON. (Ref: PIR File 2d Infantry Division.)</p>

SECRET

WAR DIARY

(CSHS-5)

Period: 240001 Sep 50
242400 Sep 50

SECOND INFANTRY DIVISION

Entry No	Time of Action	Authority	Action
6.	1800	Opn Dir 2d Inf Div	Operational directive published governing movement of the 23d and 38th Infantry Regiment. Units to coordinate and secure HYOCHON. Upon completion of this mission to make preparation to advance on Division objectives on ANUI and KOSANG. The 23d Infantry to proceed W out of HYOCHON to KONGJI-RI generally S to CHANGJON-RI (Boston) then N to CHANGDAN-RI then NW to TAEBYONG-MYON (Detroit) continue NW then W to UNGGOK then N by W to HWACK-TONG (Chicago) then W to CHANGHONG-DONG then N and E to CHOMAYON-DONG then generally N to MUCHON-RI (Omaha) then generally S by W to WONDORI then to ANUI the Division objective. 38th Infantry to proceed by most direct route N out of HYOCHON to MYOSAN-MYON (Seattle) then SW to KWONBIN-RI then due W to TALYA-RI (Yakima) then N to KOSANG (San Jose) Division objective. (Ref: Opn C and Dir, 2d Inf Division.)
7.	2210	C/S Log Entry #163	Call received that communications established with Division Artillery. (Ref: C/S Report, 2d Infantry Division.)
8.	2400	FOR #150 2d Inf Div	Composition of friendly forces remains unchanged. 9th RCT (-) to move to vicinity of CHOGYE (1125-1400) on 25 September 1950. 2d Battalion, 9th RCT to remain in present position with same mission. Results of operations: 9th RCT: 2d Battalion two (2) platoons, F Company reinforced attempted reconnaissance in force to HYOCHUNG (1145.0-1417) at 1800. Patrol unable to cross line of demarcation because of observed mortar and artillery fire. Another patrol dispatched at 1600 on same mission. 23d RCT: 2d Battalion spearheaded by an armored column and followed by 2d Battalion have advanced 15,000 yards NW against scattered enemy resistance. Lead elements entered HYOCHON at 1030I and occupied high ground overlooking city from South. A Company reinforced executed reconnaissance in force from vicinity (1138.5-1389.5) S to vicinity (1135-1380). Moderate resistance encountered and remainder of 1st Battalion sent to destroy enemy in vicinity. 38th RCT: Attacked W toward HYOCHON against determined enemy resistance. 1st Battalion drove W along main road from (1121.0-1401.3) to a position from (1118.3-1401.0) to (1117.0-1401.4). The 2d Battalion advanced on HYOCHON from NE captured positions indicated:

SECRET

WAR DIARY

(CSHIS-5)

Period: 240001 Sep 50
 242400 Sep 50

SECOND INFANTRY DIVISION

SECRET

Entry of
 No Action Authority

Action

Entry #8 Continued:

2d Battalion (-) (1119-1405); E Company established road block at (1118.2-1408.1) killing estimated 300 enemy attempting escape from MYOPCHON to N. F Company located at (1116-1404). 3d Battalion attacked S of MYOPCHON and captured high ground vicinity (1119-1399).

Advance of 23d RCT from S and 35th RCT from W and NE completed double envelopment of MYOPCHON by 2d Infantry Division.
 (Ref: POR File, 2d Infantry Division.)

Fred J. Meyer
 FRED J. MEYER
 Captain, Infantry
 Division Historian

SECRET

WAR DIARY

(CSHS-5)

Period: 250001 Sep 50 SECOND INFANTRY DIVISION

252400 Sep 50

Time

Entry No	Action	Authority	Action
1.	0845	C/S Log Entry #164	Contact made by C/S with Division Artillery 5 requesting study of possibility of closer tie-in with Division Artillery and Division Headquarters and consolidation of two liaison air strips. (Ref: C/S Report 2d Inf Div.)
2.	0900	G-1 Journal Entry #2	Major Robinson and party departed for HYOPCHON to reconnoiter for Division CP area. (Ref: G-1 Staff Section Report, 2d Div.)
3.	1100	C/S Log Entry #166	Major Frye, Commanding Officer, 2d Engineer (C) Battalion directed to place Major Bell in charge of bridge at HYOPCHON. FM directed to have a traffic detail report to Major Bell at bridge site in HYOPCHON to control traffic. FM at same time ordered to send traffic detail to assist in clearing traffic jam on road between CHOGYU and HYOPCHON. Signal communication to be installed at bridge site with a tie in at 38th Infantry switch. 38th Infantry ordered to proceed MYOSAN-MYON then W toward KOCHANG. 38th Infantry tanks to have priority over bridge at HYOPCHON. 23d Infantry to follow 38th Infantry heavy equipment across bridge then proceed NE to vicinity of MAECHON-DONG then west towards MYOSAN-MYON. 38th Infantry to be given priority on road from MYOSAN-MYON (Seattle) to KOCHANG upon arrival at MYOSAN-MYON. (Ref: C/S Report, 2d Inf Division.)
4.	1600	Cpn Dir 2d Inf Div	Operation Directive prepared for 65th Infantry Regiment. The 65th Infantry Regiment to protect and patrol area formerly held by 2d Infantry Division 2 of NAKTONG River from HILL 409 S to Division boundary.

Rept (-): ATCHD: 3 Btry, 15th FA Bn,
one (1) gun, 503d FA Bn, five
(5) tanks, 9th Infantry, one
(1) M19, 82d AAA AW Battalion,
one (1) M10, 82d AAA AW Battalion.

Unit to relieve 2d Battalion, 9th Infantry in position, and patrol aggressively HILL 409, HYONPONG and high ground E. Destroy all enemy encountered.

Protect Division bridge site across NAKTONG River. Patrol area S of NAKTONG River to YONGSAN-CHANGNYONG road.

Patrol Corps N-S MSR from CHANGNYONG S to YONGSAN, YONGSAN S to (1130.0-1308.4), and old 9th Infantry MSR from YONGSAN to NAKTONG River crossing. 2d Battalion, 9th Infantry will leave 4.2 mortar ammunition in position. CP location to be reported.

SECRET

WAR DIARY

(CSHS-5)

Period: 250001 Sep 50 SECOND INFANTRY DIVISION

252400 Sep 50

Time

SECRET

Entry

of

No

Action

Authority

Action

5. 1800 FIR #32
2d Inf Div

Enemy operations during period: Enemy opposition to Division advance along the CHOGYE-HYOPCHON-KOCHANG axis consists of pockets hastily organized from remnants of the enemy 2d, 4th, and 9th Divisions. Enemy action vicinity of HYONFUNG light. In S sector enemy resistance composed of small groups engaged in harrassing tactics.

Enemy attempts to organize new positions along main avenues of approach apparently disrupted by our advances. Resistance encountered consisted mostly of small arms automatic weapons and single artillery pieces. An observer also reported prepared positions on high ground in vicinity of KOCHANG which are unoccupied.

Enemy units in contact: Vicinity of HYOPCHON enemy 2d, 4th, and 9th Divisions; vicinity of HYONFUNG elements of enemy 10th rifle division. 6th and 7th rifle divisions supposed to be W of SAMGA. Enemy group strength unknown opposite 9th Infantry sector on W side of NAKTONG.

Enemy losses: PWs 165 Casualties 71.

TAC missions during period. 0735 concentration enemy troops in KOCHANG and E along road to HYOPCHON strafed and napalmed. 0806 troops on road leading west from HYOPCHON strafed and napalmed. 0830 close ground support of 38th in advance N of HYOPCHON. 1200 enemy troops strafed and napalmed vicinity CHONG-NI (1114-1410). Troops strafed NW of HYOPCHON at 1340. 1415 column cover for 38th Infantry in advance on objective. 1500 village 2 miles N of KOCHANG (SOBYON-NI). S-26s at 1725 strafed bridges in close support of 23d Infantry Regiment and also dropped 26 rockets; 56 fragmentation bombs and 30 100 lb GP bombs on KOCHANG. 1800 four (4) F-51s hit KOCHANG and napalmed it. City practically destroyed.

(Ref: FIR File, 2d Infantry Div.)

6. 2400 FOR #153
2d Inf Div

Composition of friendly forces remained unchanged during period. 9th RCT (-) to move one BCT from present position to SAMGA (1112.0-1383.0) with mission of clearing area on Division left flank of enemy resistance.

Results of operations: 9th RCT (-): 1200 1st Battalion moved by vehicle to present positions in vicinity of CHOGYE (1123.5-1400.6). C Company reinforced with one section of HMG and one section of AAA, proceeding to positions to relieve 1st Battalion. At 1200 1st Battalion placed under direct control of Division and to remain in present positions. CP of 9th RCT (-) closed in new CP vicinity CHOGYE at 09001 September 1950.

SECRET

WAR DIARY

(GSHIS-5)

Period: 250001 Sep 50 SECOND INFANTRY DIVISION
 252400 Sep 50

Entry
 No of
 Action Authority

Action

Entry #6 Continued:

23d RCT: Continued to advance to the N to vicinity (1122-1415) to clear area of enemy resistance. Upon reaching location to move W to follow advance of 38th RCT.

38th RCT: Made advances of 30,000 yards during period with only slight enemy resistance. Last reported position of lead Battalion, 2d Battalion, 38th RCT vicinity (1095-1412).

Division Artillery: Continued to fire support missions in vicinity of HYOFCRON and N.
 (Ref: POR File, 2d Inf Div.)

Fred J. Meyer
 FRED J. MEYER
 Captain, Infantry
 Division Historian

SECRET

WAR DIARY

(CSHIS-5)

Period: 250001 Sep 50 SECOND INFANTRY DIVISION
 252400 Sep 50

SECRET

Entry No	Time of Action	Authority	Action
1.	1000	C/S Log Entry #168	Advance elements of Division CP moved to new location at HYOPCHON (1115.7-1401.4). (Ref: C/S Report, 2d Inf Div.)
2.	1130	G-1 Journal Entry #2	Received 500 ROK EM. Assigned as follows: 38th Infantry 200, Division Artillery 200, 72d Tk Battalion 75, 2d QM Company 25. (Ref: G-1 Staff Section Report, 2d Infantry Division.)
3.	1230	C/S Log Entry #170	Executive Officer 9th Infantry informed C/S that 3d Battalion 3000 yards N of SAMGA and in contact with the enemy. Executive Officer 9th Infantry requested mine sweepers. Radio relay station for communication being set up halfway between HYOPCHON and SAMGA. (Ref: C/S Report, 2d Inf Div.)
4.	1530	C/S Log Entry #171	Rear elements of Division CP departed for new CP vicinity of HYOPCHON. Arrived at new CP 1830 hours. (Ref: C/S Report, 2d Inf Division.)
5.	1800	PIR #33 2d Inf Div	<p>Enemy operations during period: Enemy appeared incapable of halting friendly advance and lead elements of Division entered village during morning. Resistance confined to small groups occupying critical terrain along axis of advance into KOCHEANG. On S flank of Division zone enemy fought stubborn resistance to attempts to take SAMGA. Elements of enemy 7th Division identified through PWs. Considerable quantities of materiel, equipment and ammunition reported captured or over-run during period.</p> <p>Enemy capabilities remain relatively unchanged. Indications of continued withdrawal of KOCHEANG have been reported. Fall of HYOPCHON and KOCHEANG forced enemy to withdraw and denied him opportunity of defending on high ground between two towns.</p> <p>Enemy losses. PWS 300 as of 061500 Casualties undetermined.</p> <p>Enemy units either by-passed or forced to withdraw, contact limited to small unit engagements with units previously in contact.</p> <p>Total of 28 sorties flown in support of Division operations by F4U air. All missions either in close support or armed reconnaissance on 2 and 3 routes of advance of the Division.</p>

SECRET

WAR DIARY

(CSHS-5)

Period: 260001 Sep 50
262400 Sep 50

SECOND INFANTRY DIVISION

SECRET

Entry of Action Authority Action

Entry #5 Continued:

- 0855 truck destroyed vicinity of SAMGA; troops strafed on road 2 miles SW of ANUI; 1400 troops strafed and enemy road block neutralized vicinity (1122-1414) near HAPKA-DONG. 1625 enemy guns strafed vicinity (1123-1416). 1700 troops and supplies strafed SAMGA. Village burned, minor explosions occurring. (Ref: PIR File, 2d Infantry Division.)
6. 1900 C/S Log
Entry #172 Commanding Officer, 38th Infantry called and informed C/S that one Battalion 23d Infantry between 38th and objective. Requested that 23d Infantry be informed to remain in place until 38th Infantry clears. (Ref: C/S Report, 2d Infantry Division.)
7. 1915 C/S Log
Entry #173 C/S instructed 23d Infantry to remain E of MYOSAN-MYON and remain there until receiving Division order. (Ref: C/S Report, 2d Inf Division.)
8. 1930 C/S Log
Entry #174 Executive officer 23d Infantry informed C/S that message delivered and organization told to get off road and let the 38th Infantry pass. 23d Infantry instructed to send 1 BCT to KORYONG to destroy any enemy in vicinity and capture town. (Ref: C/S Report, 2d Div.)
9. 2145 C/S Log
Entry #176 C-4 informed to contact Corps to get Engineers to commence work on main supply route from HYOCHON to rear. (Ref: C/S Report, 2d Div.)
10. 2400 FOR #156
2d Inf Div Composition of friendly forces: 2d Infantry Division closed CP at (1131.0-1400.5) and opened (1115.7-1401.4) at 261515I September 1950. (1st CP Vicinity TUGONS-NI 2d CP HYOCHON). All units to continue advance in zone.
- Results of operations: 9th RCT (-): 0730 1st Battalion moved from vicinity SINGAN-NI to vicinity IPSON-NI to locate and destroy enemy ammunition dump. Mission accomplished at 1800I. 260545 the 3d Battalion, departed assembly area (CHOLLE) for SAMGA (1112-1393). 1240 motor column held up 4,000 yards N of SAMGA by estimated reinforced company. 3d Battalion now located vicinity of HILL 201 N of SAMGA (1114-1397).
- 23d RCT: 1st Battalion proceeded NE from HYOCHON to vicinity 3,000 yards N of HAPKA-DONG (1122-1414). 2d and 3d battalions proceeded N to MYOSAN-MYON vicinity (1110.0-1412.5) and W to KOCHANG vicinity (1090-1415), passed through 38th RCT and continued W and S to ANUI. Objective taken 1930I September 1950.

SECRET

WAR DIARY

(GSHIS-5)

Period: 260001 Sep 50
 262400 Sep 50

SECOND INFANTRY DIVISION

Entry Time
 of
 No Action Authority

Action
 Entry #10 Continued:

38th RCT: 0630I September 1950 38th RCT
 jumped off and proceeded into KOCHANG.
 Objective taken 0920I September 1950. Road
 block vicinity (1091.3-1422.4) established.
 High ground to N occupied.

Division Artillery: Continued to fire sup-
 port missions for Division units.
 (Ref: PCR File, 2d Inf Div.)



FRED J. MEYER
 Captain, Infantry
 Division Historian

SECRET

Period: 270001 Sep 50
272400 Sep 50
Time

WAR DIARY
SECOND INFANTRY DIVISION

(GSHIS-5)

SECRET

Entry of Action Authority Action

1. 1800 PIR #34
2d Inf Div

Enemy operations during period: Last organized enemy unit E of NAKTONG in Division zone eliminated. Elements of 10th enemy division withdrew from HILL 409-KYONPUNG area. At 1620 hours patrols entered HYONPUNG and by 1800 hours two companies in possession of HILL 409. Enemy unable to defend ANUI which was entered on 261930. During night enemy placed intensive artillery fire on town. In vicinity of KORYUNG enemy fought delaying action towards town setting up successful road blocks behind advance elements using snipers to disrupt friendly movement. Estimated enemy Battalion defended high ground N of town employing mines and artillery to aid the defense. No enemy activity reported-KOCHANG area.

Enemy can withdraw from present positions, employing delaying tactics on main avenues of approach, conduct active defense with limited counterattacks, continue to infiltrate behind our present positions and cut lines of communication to isolate small units, withdraw to flanks establishing road blocks and threatening MSR. Indications are that enemy will withdraw in successive delaying positions along main avenue of approach and defend critical terrain.

Enemy losses: PWs:61 Casualties: 65

Because of weather conditions grounding planes in Japan only 23 sorties flown by tactical aircraft in 2d Infantry Division during day. 0830-1100 F-51 fighters strafed, rocketed and napalmed troops and vehicles on road leading NW out of ANUI. Possible 10 vehicles immobilized and an estimated 400 enemy troops dispersed. 1330 village of CHANCHWA-DONG, NE of KORYANG, purported to be HQ of 10th Infantry Division (NK) napalmed after troops seen entering buildings. 1430-1750 B-26's and F-51s teamed to work over troops and vehicles in KORYANG area. (Ref: PIR File, 2d Inf Div.)

2. Ltr CG, 2d
Div 26 Sep
50

Report on ROK personnel transmitted to MOSAK: "1. In reply to your msg, CX 21786 KSO, 4 September 1950, the following report is submitted as of 252400 September 1950: a. Number of ROK personnel assigned to 2d Infantry Division totals 3663.

2. Combat efficiency:

a. The efficiency of the ROK soldiers as combat infantrymen continues to deteriorate in spite of the Division being on the offensive and pursuing the enemy. All three infantry regiments and the Division artillery report that they cannot profitably absorb any additional ROK troops.

SECRET

WAR DIARY

(OSMIS-5)

Period: 270001 Sep 50
272400 Sep 50

SECOND INFANTRY DIVISION

SECRET

Entry of
No Action Authority

Action

Entry #2 Continued:

b. The combat efficiency of these soldiers is now estimated to be 10%.

3. In view of the stated opinions of my unit commanders, the low potential of these troops and the extended lines of communication now in effect, it is requested that, after receipt of 500 ROKs scheduled for delivery to this Division 28 September 1950, no further ROK replacements be furnished to the 2d Infantry Division, s/t L. B. KEISER, Major General, U. S. Army, Commanding." (Ref: G-1 Staff Section Report, 2d Infantry Division.)

3. Surg Report Entry Para 9
Colonel Barr, Theater Surgeon called Colonel Carle, Division Surgeon, reference encephalitis, stating Division had 70 patients evacuated with confirmed diagnosis resulting in 22 fatalities. Because of tactical employment, shortage of serum and lateness of season impractical to inoculate against disease.
(Ref: Surgeon Staff Section, Report, 2d Infantry Div.)

-4. 2400 FOR #159
2d Inf Div
Composition of friendly forces remains unchanged. 9th RCT to secure HYOPCHON denying enemy routes of approach to HYOPCHON, and to destroy enemy attempting to enter or cross Division zone of authority vicinity HYOPCHON. 30th RCT to attack W at 0400 along route ANUI-KOCHON-RI - CHOKBI-RI - CHINAM - RI (1037-1427) FUKANG-RI - JONGJU. 23d RCT to secure KOCHANG and ANUI and be prepared to resume offensive on relief of 1st Battalion from present mission. 65th Infantry to relieve 2d Battalion, 9th RCT on 28 September 1950. 2d Battalion, 9th RCT to relieve 1st Battalion, 33d RCT of present mission on 28 September 1950.

Results of operations: 9th RCT: 1st Battalion moved from vicinity SINAM-RI to SANJI-RI arriving at destination 15301 September 1950. To patrol W to (1132.0-1415.2) and to protect Division MSR. 2d Battalion dispatched reconnaissance in force to vicinity of HYOPFUNG at approximately 07001. Light resistance encountered. E and F Companies brought up to establish position on HILL 409 at 16451. No resistance encountered. Patrols sent to HAKTONG River vicinity of HILL 409 for possible crossing site. 3d Battalion continued to drive S toward SAMGA meeting heavy enemy resistance. Extensive mine fields encountered and stubborn enemy defense of HILLS 277 and 201 delayed advance. Attack on SAMGA to continue 28 September 1950.

23d RCT: 1st Battalion continued attacking N toward KORTONG (1135-1421). Narrow road conditions impeding attack coupled with small enemy groups between KORTONG-RI and HAKA-

SECRET

WAR DIARY

(CSHIS-5)

Period: 270001 Sep 50
 272400 Sep 50

SECOND INFANTRY DIVISION

Entry of
 No Action Authority

Action

Entry #4 Continued:

DONG. Heavy enemy resistance overcome and attack continued to vicinity of (1125-1420) where well organized enemy defenses encountered. Battalion captured high ground at (1124.5-1420.3) but withdrew prior to darkness to reorganize for attack on 28 September 1950. 2d and 3d Battalions remained in ANUI patrolling ten miles W and 8 miles S with tanks and infantry. Intense artillery fire received ANUI approximately 0400I September 1950.

38th RCT: Patrolled roads to N and NW and manned roadblocks in preparation for resumption of offensive. At end of period in vicinity of KOCHANG (1090-1415).

(Ref: FGR File, 2d Inf Div.)

Fred J. Meyer
 FRED J. MEYER
 Captain, Infantry
 Division Historian

WAR DIARY

(CSHIS-5)

Period: 280001 Sep 50 SECOND INFANTRY DIVISION
 282400 Sep 50

~~SECRET~~

Entry No.	Time of Action	Authority	Action
1.	0900	G-1 Journal Entry #4	Advance party departed for CP area vicinity of ANUI. (Ref: G-1 Staff Section Report, 2d Infantry Division.)
2.	1159	G-1 Journal Entry #5	Division CP left vicinity of HYOPECHON for new CP area vicinity of ANUI. (Ref: G-1 Staff Section Report, 2d Inf Div.)
3.	1200	G-1 Journal Entry #1	Report received that 38th Infantry had captured CHONJU advancing 80 miles in 8 hours. (Ref: G-1 Staff Section Report, 2d Infantry Division.)
4.	1810	G-1 Journal Entry #2	Division Forward established in CP vicinity of ANUI. (Ref: G-1 Staff Section Report, 2d Infantry Division.)
5.		Surge Report Paragraph 10	Division CP moved beyond range for Helicopter evacuation. Arrangements made with Division G-3 Air for use of L-5 for evacuation of seriously wounded. (Ref: Surgeon Staff Section Report, 2d Inf Div.)

Fred J. Meyer
 FRED J. MEYER
 Captain, Infantry
 Division Historian

SECRET

Period: 290001 Sep 50
292400 Sep 50

WAR DIARY
SECOND INFANTRY DIVISION

(CSHS-5)

SECRET

Entry No.	Time of Action	Authority	Action
1.	1700	G-1 Journal entry #4.	Colonel Wolfe (Army Ground Forces) requested copy of daily casualty report of Division. (Ref: G-1 Staff Section Report, 2d Infantry Division.)
2.	2400		No other significant activities during period.

Fred J. Meyer
FRID J. MEYER
Captain, Infantry
Division Historian

SECRET

WAR DIARY

(CSHIS-5)

Period 300001 Sep 50

SECOND INFANTRY DIVISION

302400 Sep 50

SECRET

Entry No	Time of Action	Authority	Action
1.	0930	G-1 Journal Entry #4	Negatives of atrocity pictures taken in 2d Infantry Division zone vicinity of ANUI and CHONJU sent to Chief Signal Officer, 3WA, ATTN: Photo Officer. (Ref: G-1 Staff Section Report, 2d Infantry Division.)
2.		G/S Log 2d Inf Div	Staff meeting held with General Staff and following special staffs: Sig, QM, Surg, Engr, and Hq Comdt. Projected plans for moving all services up and closing rear areas, leaving the 6th Regiment in control of the MUCFCHON area. Staff directed to make necessary arrangements to accomplish. Equipment which could not be brought forward would be taken to Pusani and moved by water. G-4 instructed to establish road priorities with tactical units given preference. (Ref: G/S Report, 2d Inf Div.)
3.	1800	FIR #36 2d Inf Div	Enemy operations during period: 38th Infantry dispatched patrols both forward and to rear of present positions. Patrol proceeding to PUMC encountered no enemy resistance. Patrols in area 8 miles S of CHONJU captured 37 PWs, 10 American made 37mm AT guns, and 50 case of mortar and small arms ammunition. Patrols encountered no enemy in HOSAN area. Recreative patrol results in JMA-WON. 68th RCT took 26 PWs in vicinity of HILL 409 (1139-1415). During period 84 prisoners taken. Area in vicinity of HILL 409 extending N to Division boundary vicinity (1142-1430) extensively mined. Enemy losses: PWs 264. Casualties Unknown. (Ref: FIR File, 2d Infantry Division.)
4.		Peris. Periodic Report #6	<p>Losses during period 23-30 September 1950: 440 including MIA and non-battle casualties (325 battle, 105 non-battle), while only 390 replacements were received through replacements channels and hospital returnees. 9 MIA returned from MIA.</p> <p>300 ROKs received during period and assigned: 9th Infantry 25, 36th Infantry 25, 2d Mod Bn 75, 2d Sig Co 25, 2d QM Co 25, 702d Ord Co 50, 72d Tk Bn 75.</p> <p>Critical shortage of riflemen continuing. Company grade Field Artillery Officers as forward observers also presenting problem.</p> <p>Division not desirous of integrating any additional ROK soldiers into units. All commanders have expressed reluctance toward accepting any additional ROK personnel.</p> <p>101 internments of which 91 were identified in 2d Infantry Division Cemetery at MICHAM. (Report up to and including 28 Sep reports of 29-30 Sep to be included in succeeding periodic report.) All identified burials were members of the 2d Infantry Division, including all 2d ROK troops.</p>

SECRET

Period: 300001 Sep 50
302400 Sep 50

WAR DIARY
SECOND INFANTRY DIVISION

(CSHIS-5)

Time

SECRET

Entry of
No Action Authority

Action

Entry #4 Continued:

Awards and decorations - during period the A and D board processed awards for one (1) DSC, thirty eight (38) SS, eighty (80) BS, seven (7) DFC, and seventy-seven (77) air medals.

Investigation being conducted by the JA of 2d Division to determine authenticity of reported atrocities within the Division zone.
(Ref: G-1 Staff Section Report, 2d Infantry Division.)

Fred J. Meyer
FRED J. MEYER
Captain, Infantry
Division Historian

SECRET

WAR DIARY

(CSHS-5)

Period: 020001 Oct 50
022400 Oct 50

SECOND INFANTRY DIVISION

SECRET

Entry No	Time of Action	Authority	Action
1.	0157	G-3 Journal 2d Inf Div Entry #1	Permission granted by IX Corps for Division elements to cross into zone of I Corps at KOMJU, CHOMAN, ONCHON-NI and to turn back into proper zone as soon as feasible. (G-3 Journal, 2d Inf Division.)
2.	0231	G-3 Journal Entry #4	38th Infantry instructed that permission granted to cross into I Corps Zone. 2d Recon attached to 38th as of 020600. (Ref: G-3 Journal, 2d Infantry Div.)
3.	0548	G-3 Journal Entry #8	38th Infantry made contact with 1st Battalion of 35th Infantry at a point 5 miles from YONGANG-RYUAN. Contact established with 19th Infantry Regiment at KANGJU. At WACHON-NI approximately 10 miles from this point contact made with 1st Battalion 5th RCT. (Ref: G-3 Journal, 2d Inf Div.)
4.	1200	G-3 Journal Entry #21	23d CP opened CHONJU at 1000 hours. (Ref: G-3 Journal, 2d Inf Div.)
5.	1450	G-3 Journal Entry #32	23d CP opened vicinity (1007-1430) at 021400I Oct 50. (Ref: G-3 Journal, 2d Infantry Division.)
6.	1620	G-3 Journal Entry #38	Message transmitted to IX Corps requesting information of any night patrolling contemplated by I Corps in 2d Div zone. Timely notification requested in all such instances. (Ref: G-3 Journal, 2d Inf Div.)
7.	1620	G-3 Journal Entry #39	Division Artillery, CO 9th RCT, and CO 23d RCT informed that AAA batteries attached to respective organizations were to revert to control of CG Division Artillery 030600 October 1950. (Ref: G-3 Journal, 2d Inf Division.)
8.	1625	G-3 Journal Entry #40	CO 23d RCT and CO 72d Tk Battalion informed that G Company 72d Tk Bn effective 030600 October reverts to control of 72d Tk Bn. (Ref: G-3 Journal, 2d Inf Div.)
9.	1735	G-3 Journal Entry #44	Message received from IX Corps requesting information on disposition of 19th Infantry Regiment. (Ref: G-3 Journal, 2d Inf Div.)
10.	1800	PIR #37 2d Inf Div	Enemy operations during period. Enemy activity confined chiefly to firing on patrols. Reports being received through civilian agencies on locations of concentrations of enemy soldiers dressed in civilian clothing. Evidence of mass murder of civilians by enemy discovered at SOCHON (0959-1461). Local reports from civilian populace indicate that approximately 500 persons taken into a warehouse, saturated with gasoline and set on fire.

Enemy capabilities at this date seem to indicate that forces will continue withdrawals

SECRET

WAR DIARY

(GSHIS-5)

Period: 020001 Oct 50
022400 Oct 50

SECOND INFANTRY DIVISION

Entry
No of
Action AuthorityAction
Entry #10 Continued:

to the N beyond Division boundary leaving large groups behind dressed in civilian clothes. Increased guerrilla activity to be expected in Division zone.

Enemy losses: PWs 89 Casualties 45.
(PIR File, 2d Infantry Division)

11. 1828 G-3 Journal 38th Infantry instructed not to send out
Entry #49 any long range patrols as an alert order
 received from IX Corp that entire RGT to
 replace 19th RGT at KONGJU on the night of
 4 Oct 50. (Ref: G-3 Journal, 2d Inf Div.)
12. 1850 G-3 Journal Disposition of 9th Infantry as of 012400:
Entry #54 1st Bn ANUL; 2d Bn (less F Co in process of
 relieving unit of 23d Inf in CHOKET-RI.),
 3d Bn reports mines apparently freshly
 laid encountered at TOCHON-NI 012130.
 (Ref: G-3 Journal, 2d Inf Div.)
13. 1950 G-3 Journal 38th Infantry called reference location of
Entry #60 CP 19th Infantry. 19th contacted at both
 KONGJU and TAEJON. (Ref: G-3 Journal,
 2d Infantry Division.)
14. 2135 G-3 Journal Request made by 38th Infantry for liaison
Entry #69 plane to take representative to 24th Divi-
 sion CP to confer on replacement of 19th
 Infantry. C/S authorized use of plane for
 3 Oct 50. (Ref: G-3 Journal, 2d Inf Div.)
15. 2215 G-3 Journal 65th RGT reported difficulty in bringing
Entry #70 armored FA Bn Batteries across Pontoon
 bridge due to weight. Also indicated that
 tank company with M43s anticipated to arrive
 PUSAN enroute to MIRYANG this week late for
 motor movement W to join RGT. (Ref: G-3
 Journal, 2d Infantry Division.)
16. 1500 Ltr of Instr 2d Infantry Division to continue on missions
2d Inf Div presently assigned and expedite destruction
 of organized enemy resistance in entire zone
 of authority. Be prepared on Corps O to
 assemble one (1) RGT for employment in Z of
 25th Infantry Division.

38th RGT: Patrols only to be utilized N of KUM river unless organized enemy resistance located. Temporary patrol bases N of KUM River will be established.

65th RGT: Motorized patrols to be used E of NAKTOM River until floating bridge removed. One (1) patrol to be dispatched daily over southern route to MIRYANG, and return the following day. One (1) patrol to be dispatched daily over N route to MIRYANG, and return the following day.

WAR DIARY

(CSHIS-5)

Period: 020001 Oct 50
022400 Oct 50

SECOND INFANTRY DIVISION

Time
Entry of
No Action Authority

Action
Entry #16 Continued:

2d Division Artillery (-): Move to vicinity of KOSAN. Patrol road net NE from KOSAN. Patrols will be coordinated with 23d RCT.

ROK National Police to continue to be alerted at present location for immediate return to home station in each regimental area after organized enemy resistance overcome.

Units will initiate extensive patrolling in zones to destroy all enemy forces encountered. All usable roads in sector to be patrolled.

Contact should be established with adjacent units for exchange of information.

All male personnel who appear because of actions to be suspected NK soldiers or collaborators will be apprehended. Screening will be conducted under supervision of regimental commanders. Each regiment will be assisted by CIC Team consisting of two special agents, an IPW Team consisting of one officer and three enlisted men, local Korean CIC as available, and local police.

Major Koeber designated as Special Staff Officer, coordinating screening activities. Evacuation and disposition of NK soldiers to be through POW channels: 38th and 23d to Div POW at CHONJU; 9th and 65th to Div POW at ANUI.

Political collaborators, NK Army Laborers, and SK impressed into the NK Army since 5 September to be turned over to local authorities for disposition.

All units to assist Ordnance in evacuation of enemy equipment by collecting and placing in dumps on roads suitable for 2 1/2 ton 6x6 trucks and reporting location direct to AC or S 3-4 for pickups by ordnance teams. Enemy equipment will be guarded until picked up by ordnance or relieved by SK National Police.

(Ref: Opn O, Dir, and Ltr Instr File, 2d Infantry Division.)

FRED J. MEYER
Captain, Infantry
Division Historian

WAR DIARY

(GSHIS-5)

Period: 030001 Oct 50
032400 Oct 50

SECOND INFANTRY DIVISION

Entry No	Time of Action	Authority	Action
----------	----------------	-----------	--------

1.	1200	Opn O 8. 2d Inf Div	Composition of friendly forces: Task Orgn:
----	------	------------------------	--

9th RCT: 9th Inf Regt, 15th FA Bn((-) air section.

23d RCT: 23d Inf Regt, 37th FA Bn((-) air section.

38th RCT: 38th Inf Regt, 38th FA Bn, Company C, 82d AAA AW Bn.

Div Arty (-): Hq & Hc Btry, Div Arty, 503d FA Bn, 82d AAA AW Bn (-), 15th FA Bn Air Sec, 37th FA Bn air section.

IX US Corps assumes responsibility for present I US Corps Z, protects line of communications SEOUL-SUWON-TAEJON-TAEJU-PUSAN, continues to destroy enemy forces in Z in conjunction with ROK police and prepares to assume responsibility for SEOUL area after movement of I Corps to the N. 11th ROK Div, under IX US Corps control, will be moved to the NAMWON-KWANJU-CHONJU area and will upon arrival assume responsibility SW portion of Korea.

2d Inf Div to move one RCT to area A and relieve elements of 24th US Inf Div prior to darkness 4 Oct 50; move 65th RCT to area B and relieve 27th British Brigade prior to darkness 4 Oct 50; Div (-) to continue presently assigned missions in Z prescribed in Ltr of Instruction Number 1 IX US Corps, 1 Oct 50; be prepared on Corps order to assume responsibility for the SUWON (1001-1609) ANSON (1027-1576) YOJU (1063-1610) area on or after 5 Oct 50; after completion of the above missions be prepared on Corps order to assemble in the SEOUL-SUWON area not later than 15 October 1950 and revert to EUSAK Reserve.

9th RCT: Assemble in the vicinity of MONSAN-MOSANG area, move minimum of one BCT on RCT organic transportation 5 October 1950. 25-30 trucks to be made available by Division Transportation Officer to move remainder of RCT 6 October 1950. Movement to be completed 6 October by dark.

23d RCT: Move 3d BCT to vicinity YOSAN 5 October utilizing RCT organic transportation, continue patrol missions, effective 5 October limit patrols to area W of CHONJU.

38th RCT: Move to area A and relieve elements 24th Infantry Division prior to darkness 4 October 1950. Move one BCT 3 October 1950 using RCT organic transportation, balance RCT to move 4 October 1950. Division Trans Officer to furnish 25-30 vehicles for this move. On arrival motorized patrols to be initiated throughout area.

WAR DIARY

(CSHIS-5)

Period: 030001 Oct 50 SECOND INFANTRY DIVISION

032400 Oct 50

Time

Entry

of

No

Action Authority

Action

Entry #1 Continued:

Division Artillery (-): Continue present mission.

2d Engineer (C) Battalion (-): Continue present mission.

2d Reconnaissance Company: Assemble in the vicinity CHUOE-MYON (1010-1504) and be prepared to move on Division Order.

72d Tank Battalion: Complete assembly in the vicinity of YOSAN.

65th RCT: Relieve 27th British Brigade in Area 3 as directed in Operation Order 4, IX US Corps. Relief to be completed prior to darkness 4 October 1950.

CP's of units to be as follows:

2d Inf Div: CHONJU

2d Div Arty: KOSAN

38th RCT: Vicinity of center battalion, exact location to be reported.

9th RCT: NOKSAN

23d RCT: CHONJU

72d Tr Bn: YOSAN

2d Recon Co: CHUOE-MYON

2d Engr (C) Bn: CHONJU

(Ref: Opn O and Dir File,

2d Infantry Division.)

- | | | | |
|----|------|-------------------------------------|--|
| 2. | 1515 | G-3 Journal
Entry #44 | Major General Marquet, G-3, Major General Kean, CG 25th Div, and Col Michaelis, CG 27th RCT visited Division CP from 031500 to 031520I. (Ref: G-3 Journal, 2d Inf Div.) |
| 3. | 1800 | FIR #38
2d Inf Div | Enemy operations during period: Scattered enemy groups throughout Division zone. Enemy appears to be trying to avoid contact with friendly forces.

Enemy capabilities remain relatively unchanged.

Enemy losses: FWS 308 Casualties 34
(Ref: FIR File, 2d Inf Div.) |
| 4. | 1900 | C/S Log
2d Inf Div
Entry #191 | C/S instructed FM to conduct traffic control for the coming moves of Division units.
(C/S Report, 2d Infantry Division.) |
| 5. | 1700 | G-1 Journal
Entry #4 | Commendation to the troops for their successful attack and pursuit drafted and signed by Commanding General. Distribution made to company level. (Ref: G-1 Journal, 2d Infantry Division.) |
| 6. | 2400 | FOR #177
2d Inf Div | Composition of friendly forces remains relatively unchanged.

Results of operations: 9th Infantry continued 24 hour patrol of 2d Division MSR in zone and patrolling of all roads crossing MSR. |

WAR DIARY

(CSHIS-5)

Period: 030001 Oct 50 SECOND INFANTRY DIVISION
 032400 Oct 50

Entry of
 No Action Authority Action

Entry #6 Continued:

23d Infantry: 1st Battalion closed vicinity KOSAN (1017-1446) at 1800 2 October 1950. Maintained 24 hour patrols in zone on M.R.

38th Infantry: Company I, with platoon of tanks, sent to engage estimated 2-300 enemy troops vicinity INCHON-NI (1024-1470) after re-imental I & R platoon ambushed in vicinity. Patrol dispatched from 3d Battalion contacted I Company and established a perimeter defense in area at 0230. At 0600 L Company (-) joined I Company to give assistance. No contact made with enemy upon arrival. Enemy troops apparently withdrew under cover of darkness. 2d Battalion, cleared KONSAM (1009-1478) at 081500 enroute to vicinity MUSONG (1023-1497).

65th RCT: Continued 24 hour patrol in zone on M.R. and cross roads.

2d Division Artillery: Division Artillery CP closed in new location vicinity KOSAN 031400I. Continued to assemble 503d FA Bn vicinity 2d Division Artillery CP. On completion to revert to general support 2d Infantry Division.

2d Engineer (C) Battalion: M.R. maintenance, clearing and construction of roads.
 (REF: FCR File, 2d Infantry Division.)

Fred J. Meyer
 FRED J. MEYER
 Captain, Infantry
 Division Historian

WAR DIARY

(GSHIS-5)

Period: 040001 Oct. 50 SECOND INFANTRY DIVISION
 042400 Oct 50

Entry No	Time of Action	Authority	Action
1.	0730	G-1 Journal Entry #1	Recapitulation of total number of prisoners taken by 2d Infantry Division - 3,028. (Ref: G-1 Journal, 2d Inf Div.)
2.	0850	C/S Log Entry #192	C/S informed by FM that advance party of 25th Division one mile S of CHONJU consisting of 14 2 ton 4x4 trucks. C/S directed FM to let Advance party go through but to hold up main body. (Ref: C/S Report, 2d Inf Div.)
3.	1400 / 1920	C/S Log Entries 193, 194, 195, & 196.	23d Infantry instructed to dispatch platoon size patrol to IX Corps to investigate report of attack on VHF party. Executive Officer of 23d Infantry informed C/S that Major Russell and Lt Lamden had already gone to TX (Tempest) and would be joined there by platoon. Reported machine gun and rifle fire upon investigation turned out to be SK policeman testing weapon in c. ve. However platoon reinforced with I & R platoon to remain in area. Report of patrol action passed to Tempest - 3 (IX Corps). (Ref: C/S Report, 2d Infantry Div.)
4.	1800	PIR #39 2d Inf Div	Enemy operations during period: Continued reports of NKPA soldiers dressed in civilian clothing being received. Successful planting of mines along our MSR with three vehicles of one of Artillery Battalions being destroyed. Attack made on VHF radio relay station NW of HYOPCHON. Indications from POW channels show signs of movement S out of the Division zone. Enemy losses: PWs 291 Casualties unknown. 65th RCT reported attack by guerrillas 5 miles NW of HYOPCHON on HILL 5.5 on the 3d of October 1950. (Ref: PIR File, 2d Infantry Div.)
5.	2000 / 2030	C/S Log Entries 197, 198, & 199.	Arrangements made on request of Air Officer IX Corps to supply two planes for special mission to TAEJU. (Ref: C/S Report, 2d Infantry Division.)

Fred J. Meyer
 FRED J. MEYER
 Captain, Infantry
 Division Historian

WAR DIARY

(CSHIS-5)

Period: 050001 Oct 50
052400 Oct 50

SECOND INFANTRY DIVISION

- | Entry No | Time of Action | Authority | Action |
|----------|-------------------|---------------------------------|---|
| 1. | 1110
/
1115 | C/S Log
Entries
200 & 201 | IX Corp Executive Officer contacted reference 38th RCT going under control of the 25th Division and request made if possible for the 38th Infantry to remain under control of the 2d Division despite problem of supply. Request approved by C/S IX Corps.

IX Corps called C/S to inform him that the 2d Division would stay in present area until time needed to comply with Army orders of going into reserve on the 15th. IX Corps requested that an estimate be given of time needed for the move this information to be included in directive to be issued by Corps.
(Ref: C/S Report, 2d Inf Div.) |
| 2. | 1235 | G-1 Journal
Entry #1 | AG reported difficulty with the rail service between MASAN and CHINJU resulting in a backlog of mail and replacements, and a pile-up of 80 empty QM trucks waiting for the train to bring GI I and III supplies. 15 empty trucks were diverted to AG to move more of rear echelon M to CHONJU and 8 trucks from Division Headquarters sent to CHINJU to assist in move. (G-1 Staff Section Report, 2d Inf Division.) |
| 3. | 1800 | PIR #40
2d Inf Div | Enemy operations during period. Groups throughout zone generally non-aggressive and appearing to be concerned principally with uninterrupted movement north. Guerrilla activities expected to continue as enemy forces seek food and supplies in movement North. PW reports indicate that units or groups unable to move North are to assemble in the mountainous region of CHIRI-SAN. In places where large enemy groups located enemy defends high ground until able to disengage under cover of darkness. PWs taken during period from the 7th Div, 661 Brigade, 956 Brigade and 605 Replacement Battalion. Units originally from KUMSAN area. Est 400-500 enemy S of KONGJU and another large group of 1000 N of KONGJU and another large group of 1000 N of MASAN-RI. Local civilians turned over 143 PWs to 30th Infantry.

Enemy losses: PWs 251 Casualties 233.
(ref: PIR File, 2d Infantry Division.) |
| 4. | 2400 | FOR #183
2d Inf Div | Composition of friendly forces: 65th RCT relieved from attachment 050001 Oct 50.

9th RCT: F Co (reinf) entered town of UDONG-RI (1062-1412) encountering enemy. Enemy armed with MGs and AWC. Driven N from village into G Co. G Co (reinf) contacted enemy N of IRI vicinity (1051-1424) killing 22 and capturing 10. Patrol continued S of IRI to high ground and engaged enemy being driven N by F Co. |

WAR DIARY

(CSHIS-5)

Period: 050001 Oct 50
052400 Oct 50

SECOND INFANTRY DIVISION M

Time

Entry of
No Action Authority

Action

Entry #4 Continued:

23d RCT: Patrolled from CHINAN - KUNSAN:
Patrol engaged in fire fight with enemy. 8-10
enemy dressed in uniform and armed observed.
At KUNSAN received 11 PWs from police.

In a patrol from CHINAN - SONCHON-NI enemy
engaged in fire fight in village near CHINAN.
All enemy dressed in uniform. 4 killed 4
captured. During remainder of patrol 27
enemy PWs taken.

Patrol CHINAN to MUJU picked up 19 PWs all
armed and in civilian clothes. Approximately
10 miles N of MUJU 200 enemy observed. Patrol
approached to within 600 yards killing 2. All
enemy armed with 10 per cent dressed in white
clothing.

38th RCT: Occupied KONGJU, YUSONG, and NAM-
MYON in Division area A. Patrols established.

In vicinity of HILL 830 a company size combat
patrol accompanied by one section, C Stry,
2d AAA AW Bn and supported by B Stry, 38th
FA Bn, encountered an estimated 75-100 enemy
killing 25 and capturing 17.

2d Engineer (C) Battalion: Co A closed 051600I
(1012-1437). Usual MSR maintenance.

(Ref: FOR file, 2d Infantry Division.)

FRED J. MEYER
Captain, Infantry
Division Historian

WAR DIARY

(CSHIS-5)

Period: 060001 Oct 50
062400 Oct 50

SECOND INFANTRY DIVISION

Entry No	Time of Action	Authority	Action
1.	1800	G-1 Journal 2d Inf Div Entry #4	Colonel Teter called to report rear echelon had closed into CHONJU with all but 8 trucks. Letter due by 2200. (Ref: G-1 Staff Section Report, 2d Infantry Division.)
2.	1800	PIR #41 2d Inf Div	Enemy operations during period. Enemy activity during period confined to KONGJU area, where two organized groups fired on combat patrols from HILLS 498 and 828. In vicinity of HILL 828, 30 enemy KIA and 22 PWs taken (including 5 NKPA nurses). Combat patrols screening civilians moving along roads finding NKPA soldiers most of them S Koreans trying to reach homes. Enemy losses: Pws 275 Casualties 73. (Ref: PIR File, 2d Inf Div.)
3.	1930	G-1 Journal Entry #5	G3 held conference with Staff reference Corps Operation Order. (Ref: G-1 Staff Section Report, 2d Infantry Division.)

Fred J. Meyer
 FRED J. MEYER
 Captain, Infantry
 Division Historian

WAR DIARY

(GSHIS-5)

Period: 070001 Oct 50
072400 Oct 50

SECOND INFANTRY DIVISION

Entry No	Time of Action	Authority	Action
1.	0800	Opn Dir 2d Inf Div	Operational Directive: 35th RCT after relief by 24th RCT in Area "A" to assume responsibility for Area "E" prior to darkness 9 Oct. Will be released for movement to Army Reserve Assembly Area vicinity of SEOUL - SUWON effective 140600I Oct 50.

9th RCT to be released from missions assigned in Opn O 4, IX Corps, effective 090600 I Oct 50.

2d Inf Div (-) (3th RCT) will be released for movement to Army Reserve Assembly Area effective 110600I Oct 50.

Division to supply air surveillance by liaison aircraft of area S and N of line KUNSAN (0971-1451) NAMSON (1039-1301) SUMCHON (1048-1327) with particular attention to KWANGJU (0991-1350) MOKPO (0938-1308) area. Results of flights to be reported to Hq IX Corps, 25th Inf Div and 11th ROK Div.

9th RCT on release from present mission at 090600 I to move to NONSAN (1009-1470) - MOCONG (1013-1467) area. Move to be completed by 9 October 1950. On 130600 I Oct 50 the 9th RCT to move to Division Assembly Area with move being completed by 13 Oct 50.

23d RCT to move to Division Assembly Area on 110600 I Oct 50. Move to be completed by 11th.

Division Artillery (-): Hq & Hq Btry, 503d FA Bn, 82d AAA Bn (-) to move to a point approximately 5 miles N of CHONAM at 080600I Oct 50 to be completed 9 Oct 50. On 11 Oct 50 0600 unit to move to Division Assembly Area.

72d Tank Battalion: Move to vicinity of CHONAM (1015-1511) beginning 130600I Oct 50. Move to Division Assembly Area beginning 130600 I Oct 50.

2d Engineer (3) Battalion (-) to move to Division Assembly Area beginning 131000I Oct 50.

2d Reconnaissance Company: To continue present mission until 13 Oct 50. Move to Division Assembly Area beginning 130500 I Oct 50.

703d Ordnance Maintenance Company: Move to Division Assembly Area beginning 100600I Oct 50.

Div Hq closes CHONJU 090800 I Oct 50 and opens KUMJU 090600 I Oct 50. (Ref: Opn O 4, Dir File, 2d Infantry Division.)

WAR DIARY

(CSHIS-5)

Period: 070001 Oct 50
072400 Oct 50

SECOND INFANTRY DIVISION

Time

~~SECRET~~Entry
Noof
Action

Authority

Action

2.

1800

PIR #42
2d Inf Div

Enemy activity still confined to the area around HILL 828 SE of KONGJU. Division Air CPs operating as far S as NAMJON, SUNCHON, and KWANGJU reported only normal civilian activities along the roads and in the villages. Division reconnaissance operation conducted in NW sector of Division zone contacted an enemy force of 15 NKPA, killing 6 and continuing patrol to the Yellow Sea.

Enemy losses: PWs 314 Casualties 25.
(Ref: PIR File, 2d Infantry Division.)

Fred J. Meyer
FRED J. MEYER
Captain, Infantry
Division Historian

WAR DIARY

(CSHS-5)

Period: 080001 Oct 50 SECOND INFANTRY DIVISION
 082400 Oct 50

Entry No	Time of Action	Authority	Action
1.	1800	PIR #45 2d Inf Div	Enemy operations during period. Concentrations of enemy troops continue to be reported by PWs, civilians and local police officials. Patrols entering these areas failed to find enemy in any sizeable groups. Air observation throughout the CHONJU-NAMHON-KWANJU sector report no apparent movement. Enemy losses: PWs 131 Casualties Unk. (Ref: PIR File, 2d Infantry Division.)
2.	2000	C/S Log Entry #211	G-3 of Advance party requested C/S to remain at CHONJU until 0800 10th but to send up more of the CP on the 9th but not all of it. C/P to open at CHOMAN 0800 10 Oct 50. MP to be at ford near KONGJU to direct traffic to new location. (Ref: C/S Report 2d Inf Div.)
3.	1000	G-1 Journal Entry #1	Advance CP group left CHONJU. (Ref: G-1 Staff Section Report, 2d Infantry Division.)
4.	1800	Pers Periodic Report #7	Replacements and returnee gains during period exceeded losses for the first time since the 2d Division began operations. Losses totaled 179 including MIA, battle and non-battle casualties while gains through replacement channels and hospital returnees numbered 374. Awards and Decorations - Recommendations being processed by the A & D board for the awarding of one (1) CMH, four (4) DSG, forty-two (42) SS, thirty (30) BS and one (1) Medal of Merit. (Ref: G-1 Staff Section Report, 2d Infantry Division.)
5.	2400	PCR #192 2d Inf Div	Composition of friendly forces remained unchanged during period. Division CP to move vicinity of CHOMAN (1015-1550) 10 October 1950. 9th RGT to close in NCHSAN (1009-1478) NOSONG (1013-1487) area on 9 October 1950. 25d RGT moves to Division assembly area 11 October 1950. 38th RGT moves to Division assembly area 9 October 1950. Division Artillery moves from present position to Division assembly area 11 Oct 50. 72d Tk Bn moves to vicinity CHOMAN 12 October and from CHOMAN to Division Assembly area 13 October 1950. 2d Engineer (C) Battalion moves to Division assembly area 13 October 1950. 2d Reconnaissance Company moves to Division assembly area 13 October 1950. Results of operations: 9th RGT: 3d Bn closed CHIRAN (1042-1429) 8 October 1950.

WAR DIARY

(GSHIS-5)

Period: 080001 Oct 50
 082400 Oct 50

SECOND INFANTRY DIVISION

SECRET

Entry of
 No Action Authority

Action
 (Entry #5 Continued:)

3d Battalion patrol contacted elements of 65th RCF at KUMCHON (1111-1467) 7 October 1950. 8 Patrols on 7 October no enemy contact made.

23d RCT: 3d Battalion closed YOSAN (1009-1460) 1130I September 1950. Patrols conducted SINGYO-RI, NONSAN, YONDAM, KUMSAN, SONCHON-RI, KANGJONG-RI, MUJU, POHANG-RI. Fws picked up and guns and ammunition destroyed during patrolling.

38th RCT: In compliance with verbal instructions IX Corps, Company I dispatched 1130 to clear and secure HILL 579 (1022-1537). Hill secured no resistance encountered.

Division Artillery (-): Opened new CP vicinity CHONAN 081500.

72d Tank Battalion: Patrols dispatched with negative results.

2d Engineer (C) Battalion: Continued maintenance of MSR and ford W of KONGJU (1013-1509). (R&F: POR File, 2d Inf Div.)

 FRED J. MEYER
 Captain, Infantry
 Division Historian

WAR DIARY

(GSHIS-5)

Period: 090001 Oct 50
092400 Oct 50

SECOND INFANTRY DIVISION

SECRET

Entry No	Time of Action	Authority	Action
1.		G/S Log 2d Inf Div Entry #212	G-3 informed by G/S that the following sections on way to new CP: Surgeon, FIO, Sig-Det, Chap, Reproduction Section of G-2, majority of Headquarters Company. G-3 also informed that 250 white replacements in TAEGU being sent to NONSAN this date. Det of 2d Replacement Company to pick them up. G-2 asked if plans have been considered for moving 2d Reconnaissance Company closer to Area A. G-2 advance indicated that these instructions have not been issued. Orders to be given to 2d Reconnaissance Company. (Ref: G/S Report, 2d Inf Div.)
2.	2400	FOR #195 2d Inf Div	Composition of friendly forces remains unchanged. Division CP to close in CHONJU (1015-1431) 100800 October and open SUWCN (2002-1610) 100800 October instead of KONGJU as originally planned. Results of operations: 9th RCT:-- CP opened at NOSONG (1013-1487) at 091400 October 1950. 1st Battalion closed (1013-1484) at 091800 October 1950. 2d Battalion closed (1013-1484) at 091330. 3d Battalion closed KYONGCHON-NI (1016-1493) at 091300 October 1950. 23d RCT: 9 patrols dispatched during period. One of these patrols picked up four FWS. All other patrols made no contact with enemy. Trainin in military discipline, small unit tactics, and firing of weapons and maintenance of equipment conducted throughout period. 36th RCT: Moved to Division Assembly area. 72d Tk Bn: No enemy contact made. 2d Engr (C) Bn: No change. 2d Ren Co: Approximately 100 MI vicinity TAEN brought under fire and dispersed. (Ref: FOR File, 2d Infantry Div.)

Fred J. Meyer
FRED J. MEYER
Captain, Infantry
Division Historian

WAR DIARY

(CSHIS-5)

Period: 100001 Oct 50 SECOND INFANTRY DIVISION
 102400 Oct 50

Entry No	Time	Action	Authority	Action
1.	081600 / 101610	G-1 Journal 2d Inf Div		081600 October Advance CP stopped for night vicinity of KONGJU. 090930 October Advance CP group departed KONGJU area. 091630 October Advance CP arrived vicinity of SUWON departing SUWON area 101030 October. Arrived vicinity of YONGDONG'PO and established CP in school building 101430 October; by 1610 entire Division Forward CP established vicinity of YONGDONG'PO. (Ref: G-1 Staff Section Report, 2d Infantry Division.)
2.	0700	C/S Log 2d Inf Div Entry #214		C/S with section departed CP area CHONJU for Division assembly area vicinity of SEUL. Arrived 1850 hours. (Ref: C/S Report, 2d Infantry Division.)
3.	2400	FOR #198 2d Inf Div		Composition of friendly forces remained unchanged during period. Results of operations: 9th and 23d Inf: Maintenance of equipment and general security patrols throughout zones of responsibility. 9th Infantry to move to 2d Division assembly area 13 October 1950. 23d Infantry to move to Division assembly area 11 October 1950. 38th Infantry: 38th RCT closed Division assembly area (31954946) at 091630I. On arrival in Division assembly area, RCT status ceased and attachments reverted to control of parent unit. Regiment engaged in general reorganization and inspection of equipment. (Ref: FOR file, 2d Infantry Division.)

Fred J. Meyer
 FRED J. MEYER
 Captain, Infantry
 Division Historian

WAR DIARY

(CSHIS-5)

Period: 110001 Oct 50 SECOND INFANTRY DIVISION
 112400 Oct 50

Entry No	Time of Action	Authority	Action
1.	0800	C/S Log Entry #215	Inspection of personnel and equipment directed for 12 October 1950. (C/S Report, 2d Infantry Division.)
2.	2400	FOR #201 2d Inf Div	Composition of Friendly Forces remains unchanged.

Results of operations: 9th RCT: Security patrols dispatched within sector. Total of 21 PW's taken. Maintenance of equipment continued throughout period in preparation for move to Division assembly area 13 October 1950.

25d RCT: Closed 2d Division assembly area CS 2346 111500I October 1950. Attachments reverted to control of parent units on arrival.

38th RCT: Continued reorganization and maintenance of equipment and initiation of small unit training.

Division Artillery: Division Artillery CO opened Vicinity ANYANG-RI CS 1641 111130I October 1950. 503d FA Battalion closed assembly area vicinity ANYANG-RI CS 1642 111130 I October 1950. 13 PWs surrendered to B Battery 503d FA Battalion vicinity CHONAN CR 3575 101625I October 1950. 82d AAA AF Bn closed assembly area vicinity ANYANG-RI CS 1643 111315I October 1950. (Ref: FOR File, 2d Infantry Division.)

Fred J. Hessler
 FRED J. HESSLER
 Captain, Infantry
 Division Historian

WAR DIARY

(CSHIS-5)

Period: 120001 Oct 50 SECOND INFANTRY DIVISION

122400 Oct 50

Time

Entry
Noof
Action

Authority

Action

- | | | | |
|----|-------------------|------------------------------------|---|
| 1. | 1000 | G/S Log
Entry #216 | G/S conducted inspection of section and of the Headquarters and area. (Ref: G/S Report, 2d Infantry Division.) |
| 2. | 1300
/
1710 | G/S Log
Entries #217
and 218 | G/S departed by air for IX Corps Headquarters on staff duties in TAETON returning at 1710. (Ref: G/S Report, 2d Infantry Division.) |
| 3. | 2400 | FOR #204
2d Inf Div | Composition of friendly units remains unchanged. |

Units are to continue movement to Division assembly area.

Training program to be initiated stressing integration and training of South Korean soldiers, small unit critiques of past operations, weapons, convoy disciplines, supply discipline, and tactical training.

Results of operations: 9th RCT - Negative.

23d Infantry, 38th Infantry, and Division Artillery: Reorganization, maintenance of equipment, and initiation of appropriate training program for respective arms.

72d Tank Battalion: Moved from YCSAN CQ 2891 to vicinity CHONAN CR 3574. Closed CR 3574 at 121345 I and will continue movement to Division assembly area 13 October 1950.

2d Reconnaissance Company: Closed Division assembly area US 1853 at 121330I October 1950. (Ref: FOR File, 2d Infantry Division.)

FRED J. MEYER
Captain, Infantry
Division Historian

WAR DIARY

(GSRIS-5)

Period: 130001 Oct 50
132400 Oct 50

SECOND INFANTRY DIVISION

Entry No	Time of Action	Authority	Action
1.	0800	G/S Log Entry #219	G-3 to publish directive governing revielle and retreat formations while units in Division assembly area. (Ref: G/S Report, 2d Infantry Division.)
2.	1130	G/S Log Entry #221	Major Rolf from IX Corps G-3 reported in to C/S concerning submission of reports by G-3 and preparation of final reports prior to leaving control of IX Corps. (Ref: G/S Report, 2d Infantry Division.)
3.	1640	G/S Log Entry #223	Commanding Officer 9th Infantry called C/S relative to his arrival in Division assembly area and to report status of Regiment. (Ref: G/S Report, 2d Infantry Div.)
4.		GO #65, Hq 2d Inf Div	2d Platoon 565 Quartermaster Graves Registration Company relieved from attachment 2d Infantry Division by GO 102, Hq 8th US Army Korea, AFO 301, 6 October 1950, and further relieved from attachment to the 2d Quartermaster Company, effective 3 October 1950. (Ref: GO File, 2d Infantry Division.)
5.	1700	G-1 Journal 2d Inf Div	Division near-established in vicinity of YONGDONG'PO. (Ref: G-1 Staff Section Report, 2d Infantry Division.)
6.	2130	G/S Log Entry #224	G/S called Commanding Officer 9th Infantry for report of units enroute by rail requesting report of time of arrival and condition on arrival. (Ref: G/S Report, 2d Inf Div.)
7.	2400	FOR #207 2d Inf Div	Composition of friendly forces remains unchanged.

Results of operations: 9th RCT: Motorized elements closed Division assembly area CS 1318 at 131620I. 1st Battalion departed NCHSAN by rail 131519I. 2d Battalion departed NCHSAN by rail 131430I. 3d Battalion departed NCHSAN by rail 130953I.

Regimental CP closed CS 1318 at 131453I.

Percentage of authorized strength: 63.04

23d and 30th Regiments: Continued reorganization and maintenance of equipment and initiated respective training programs.

Division Artillery: 15th FA Battalion reverted to Division Artillery control. Closed vicinity ANYANG-NI CS 1637 at 131835I. 82d AAA Bn Battalion established anti-aircraft defenses for Division Artillery and airstrip. All firing batteries deployed and four (4) anti-aircraft intelligence service CP's established.

Period: 130001 Oct 50
132400 Oct 50

WAR DIARY
SECOND INFANTRY DIVISION

(CSHIS-5)

Entry of
No Action Authority

Action
Entry #7 Continued:

72d Tank Battalion: Moved from vicinity
CHONAN CR-3574 to Division assembly area.
Closed CS 1448 at 131215I October 1950.

2d Engineer (G) Battalion: Departed CHONJU
CS 3169 enroute to assembly area.

(Ref: FOR File, 2d Infantry Division.)

Fred J. Meier
FRED J. MEIER
Captain, Infantry
Division Historian

WAR DIARY

(CSHIS-5)

Period: 140001 Oct 50 SECOND INFANTRY DIVISION

142400 Oct 50

Entry No	Time of Action	Authority	Action
1.	0930	G/S Log Entry #225	G-1 informed by G/S that Colonel Francis Hill was referred to KWAG, Colonel Messinger to be deputy ADC, and Lt Col Coughlin to be Civil Affairs Officer. Readjustments within division to be completed before additional outside personnel to be accepted. (Ref: G/S Report, 2d Inf Div.)
2.	1000	G/S Log Entry #226	Staff meeting conducted by G/S with General Staff directing G-4 to obtain information on 24 replacement tanks due to 2d Division. Staff was directed to prepare a study of tank resources of the Division and make recommendations as to deployment and assignment. Two views to be considered in study: one based on receipt of replacement tanks the other on non-receipt. (Ref: G/S Report, 2d Infantry Division.)
3.	1030	G/S Log Entry #227	G/S called on by Doctor CHONG and Doctor YON KIM, members of the Korean National Assembly. They conveyed the gratitude of the National Assembly for the action of the 2d Division in the fight against Communists also conveying information concerning NK pockets and other intelligence information. (Ref: G/S Report, 2d Inf Div.)
4.	2400	FOR #210 2d Inf Div	Composition of friendly forces remained unchanged. Results of operations: 9th Infantry: Closed in Division assembly area at 141930I October 1950. 2d Engineer (C) Battalion: Last elements closed in Division assembly area 141400I. Battalion CP located at CS 1447. Division Rear: Closed in Division assembly area 141800I. Last elements of 2d Infantry Division closed Division assembly area 141930 October 1950. (Ref: FOR File, 2d Inf Div.)

Fred J. Meyer
 FRED J. MEYER
 Captain, Infantry
 Division Historian

WAR DIARY

(OSHS-5)

Period: 150001 Oct 50 SECOND INFANTRY DIVISION
 152400 Oct 50

Entry No	Time of Action	Authority	Action
1.	141400 / 151500	G-1 Journal 2d Inf Div	2d Infantry Division Band entertained troops of the 23d and 38th Infantry Regiments in their respective bivouac areas. (Ref: G-1 Staff Section Report, 2d Infantry Division.)
2.	1050	G-3 Journal Entry #22	Instructions received from 8th Army for 2d Division to furnish 200 ROK troops as security guards for I Corps. No American personnel to accompany ROKs. Plan to be worked out for assembling personnel. EPD unknown to be given later. Ammunition requested by S-3 Division Artillery cannot be made available because of shipping difficulties. Only ammunition on hand in excess of basic loads can be used. (Ref: G-3 Journal, 2d Inf Div.)
3.	1010	G-3 Journal Entry #21	Division Artillery S-3 requested training ammunition and was informed that because of shipping difficulties only that ammunition on hand over and above basic loads may be used for training. (Ref: G-3 Journal, 2d Infantry Division.)
4.		G-3 Journal Entry #29	9th, 23d, 38th, and Division Artillery notified 151400 October that there would be a Tactical Air Forum at Division Headquarters at 151400 October 1950. (Ref: G-3 Journal, 2d Inf Div.)
5.	2400	FOR #213 2d Inf Div	Composition of friendly forces remained unchanged. 9th RCT, 23d Inf, 38th Inf, and other divisional units continued reorganization, maintenance of equipment and small unit training. (Ref: FOR File, 2d Inf Div.)

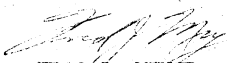
 FRED J. MEYER
 Captain, Infantry
 Division Historian

SECRET

WAR DIARY

(CSHS-5)

Period: 160001 Oct 50
162400 Oct 50

SECOND INFANTRY DIVISION

Entry No	Time of Action	Authority	Action
1.	151800	Pers Periodic Report #8	<p>Replacement and troop returnee gains during period exceeded losses by a total of 353 men. Losses totaled 109 including battle and nonbattle casualties while gains through replacement channels and hospital returnees numbered 462.</p> <p>A total of 19 ROK troops received during period. This personnel to be used as personnel and records clerks for ROK personnel.</p> <p>A total of 15 internments in Division Cemetery all of which were identified. Identified burials included 13 from the 2d Infantry Division, 4 of which were ROK personnel. 2 known dead are pending identification of organization.</p> <p>Awards and decorations: Twelve (12) SS and forty-nine (49) BS approved by the A & D Board. Recommendations being processed by the A & D Board for the awarding of four (4) DSCs, sixty-one (61) SS and eighty-seven (87) BSs. (Ref: G-1 Staff Section Report, 2d Infantry Division.)</p>
2.	1020	G-3 Journal Entry #13	<p>Message 23d Infantry artillery not to fire today. Changed until 17 October 1950. Area remains the same. (Ref: G-3 Journal, 2d Inf Div.)</p>
3.	1035	G-3 Journal Entry #14	<p>Major Howell (G-4) stated that he had been directed by G/S to get an answer concerning men from Bridge Platoon, 2d Engineer sent to I Corps with bridge equipment. G-3 to drop matter. (Ref: G-3 Journal, 2d Inf Division.)</p>
4.	1040	G-3 Journal Entry #15	<p>I Corps informed that four (4) tank dozers to be furnished by 2d Division enroute by rail from MIRYANG to SUWON. Dozers to be expedited to I Corps on arrival 2d Division area. (Ref: G-3 Journal, 2d Infantry Division.)</p>
5.	2000	G-1 Journal Entry #2	<p>All army entertainment group (Ramblin Roundup) entertained at Division Headquarters. (Ref: G-1 Staff Section Report, 2d Infantry Division.)</p>

FRED J. MEYER
Captain, Infantry
Division Historian

WAR DIARY

(OSMIS-5)

Period: 160001 Oct 50
162400 Oct 50

SECOND INFANTRY DIVISION

SECRET

Entry No	Time of Action	Authority	Action
6.	2100	Opn Dir 2d Inf Div	

Task Force INDIANHEAD under the command of Lieutenant Colonel Ralph L. Foster organized to perform missions as directed by Headquarters 2d Infantry Division or higher headquarters.

Composition of Task Force INDIANHEAD:

One (1) platoon, 72d Tank Battalion comprised of the following tracked vehicles and those wheeled vehicles deemed necessary by the Task Force Commander to carry out missions ordered: Six (6) M-26 Tanks - one (1) half-track.

One (1) platoon, 2d Reconnaissance Company, to include the following tracked vehicles and those wheeled vehicles deemed necessary by the Task Force Commander to carry out missions ordered: Two (2) M-24 Tanks - one M-39 Personnel Carrier.

One (1) Infantry Company from 30th Infantry. Officer strength will include six (6) officers in addition to Company Commander. Company to be motorized.

One (1) Engineer Demolition Squad comprised of one (1) officer and fourteen (14) EM. Equipment of squad will include one (1) 2 1/2 ton truck, one (1) engineer platoon demolition set, and one (1) engineer pioneer set.

One (1) section of AAA AW Battalion from 62d AAA AW Battalion (SF) (Section will be commanded by an officer) to be comprised of the following tracked vehicles: 1 M-16 and 1 M-19.

Medical section to be comprised of one (1) doctor and two aid men with sufficient medical equipment to support task force.

Selected personnel from 2d CIC Detachment.

Task Force Indian Head will assemble at 2d Reconnaissance Company area by 171000 Oct 1950.

All units to assemble with basic load of ammunition and POL. Rations and additional logistic support will be forwarded by AG of 3, 3-4 as called for by Task Force Commander. (Ref: Opn C and Dir File, 2d Inf Div.)

WAR DIARY

(CSHIS-5)

Period: 160001 Oct 50 SECOND INFANTRY DIVISION

162400 Oct 50

Time

Entry
Noof
Action

Authority

Action

7. 2400 PCR #216-2d Inf Div Composition of friendly forces remained unchanged.

Results of operations: 9th and 20th Infantry continued reorganization, maintenance of equipment, and small unit training.

23d Infantry: Dispatched Company I Reinforced with one section 75mm recoilless rifles, 81mm mortars and heavy MG's dispatched to investigate report of estimated 150 enemy troops in vicinity of HILL 544 CS 2442. No contact made with enemy. (Ref: PCR File, 2d Inf Div.)

Fred J. Meyer
FRAD J. MEYER
Captain, Infantry
Division Historian

WAR DIARY

(GSHIS-5)

Period: 170001 Oct 50 SECOND INFANTRY DIVISION
 172400 Oct 50

Entry No	Time of Action	Authority	Action
1.	1500	G-1 Journal Entry #1	Band concert at Division CP by 2d Division band. (Ref: G-1 Staff Section Report, 2d Infantry Division.
2.	1500 1700	Opn Dir 2d Inf Div	Operational Directive: 2d Infantry Division (-) remains in EUSAK Reserve present position prepared for employment in I Corps Zone when ordered.

Composition of 9th RCT:

9th Inf: AFHQ: 15th FA Bn
 Co A, 2d Engr (C) Bn
 Btry D, 82d AAA AW Bn (SF)
 31st Flot, 2d Medical Bn
 AWB Flot, 2d Med Bn

Attached to I US Corps effective 170045I October 1950. Mv to vic SINGYE BT 6584 at first light 18 October. Additional transportation will be made available by this Headquarters. This additional transportation to be returned upon completion of move to SINGYE. Commanding Officer, 9th RCT to report to Commanding General 1, I US Corps for assignment of mission.

23d RCT no change.

38th Infantry: Rel class of 187th Airborne Regiment currently securing NAM River bridge vic SUCUL with one (1) Company. Accomplish relief and assume responsibility for security of subject bridge prior to 171800I October 1950. Direct communication with 187th Airborne Regiment authorized.

Division Artillery: 15th FA Bn and Btry D, 82d AAA AW Bn (SF) attached to 9th RCT effective 170045I October 1950.

72d Tank Battalion: No change.

2d Engineer (C) Battalion: Company A attached to 9th RCT effective 170045I October 1950.

2d Medical Battalion: One (1) Clearing Platoon, one (1) Ambulance Platoon attached to 9th RCT effective 170045 I October 1950.

3. 2400 FOR W/S
 2d Inf Div

Composition of Friendly Forces: 9th RCT (9th Inf, 15th FA Bn, Co A, 2d Engr (C) Bn, Btry D, 82d AAA AW Bn, 31st Flot and AWB Flot, 2d Med Bn) attached to I US Corps effective 170045I October 1950.

9th RCT to move to vicinity of SINGYE BT 6584 beginning 180300I. Co I, 2d Infantry to relieve 187th Airborne Regiment of responsibility for NAM River bridge vicinity of SUCUL prior to 180300I.

Period: 170001 Oct 50
172400 Oct 50
Time

WAR DIARY
SECOND INFANTRY DIVISION

(CSHIS-5)

Entry
No Action Authority

Action

Entry #3 Continued:

Results of operations: 9th Infantry reorganized into RCT formation for movement to SINGHE ET 0504 under I US Corps order. RCT commander reported to CG I US Corps for assignment of mission.

23d Infantry continued reorganization and training.

30th Infantry: Company I relieved elements of 187th Airborne Regiment and assumed responsibility for security of HAN River Bridge vicinity SEJUL at 171500I October 1950.

Other Divisional Units continued reorganization and training.

Task Force Indianhead: Departed assembly area 171630I October 1950.

(Ref: For File, 2d Infantry Division.)

FRED J. MEYER
Captain, Infantry
Division Historian

WAR DIARY

(CSMIS-5)

Period: 180001 Oct 50 SECOND INFANTRY DIVISION

182400 Oct 50

Entry No	Time of Action	Authority	Action
1.	171700 / 181800	C1 to Cpn Dir 2d Div	Operation Directive of 171700I October 1950 changed to add the following Signal Detachment to list of units attached to the 9th Infantry. (Signal Detachment composed of one (1) VHF Team, one (1) Radio Team, and one (1) Wire Construction Team.) (Ref: Cpn O and Dir File, 2d Infantry Division.)
2.	1830	G-2 Journal Entry 1796	Elements of Task Force Indianhead had two (2) serials in SARIWON and one (1) serial in SINMORH at 181400. (Ref: G-2 Journal, 2d Infantry Division.)
3.	2400	FOR #222 2d Inf Div	Composition of friendly forces remained unchanged.

Results of operations: 9th RCT, all elements, cleared 2d Division assembly area 180810I enroute to vicinity SINGYE BT 8564. Upon arrival 9th RCT to revert to operational control I Corps.

23d Infantry, 36th Infantry, and other Division units continued reorganization and training. (Ref: FOR File, 2d Inf Div.)

Fred J. Meyer
 FRED J. MEYER
 Captain, Infantry
 Division Historian

WAR DIARY

(CSHIS-5)

Period: 190001 Oct 50
192400 Oct 50

SECOND INFANTRY DIVISION

Time
Entry
No. of
Action Authority

Action

1. 2400 FOR #225
2d Inf Div
- Composition of friendly forces remains unchanged. 23d Infantry, 50th Infantry, and other Divisional Units continued reorganization and training and maintenance of equipment. (Ref: FOR File, 2d Infantry Division.)

Fred J. Meyer
FRED J. MEYER
Captain, Infantry
Division Historian

WAR DIARY

(CSHS-5)

Period: 200001 Oct 50
202400 Oct 50

SECOND INFANTRY DIVISION

~~SECRET~~

Entry No	Time of Action	Authority	Action
1.	2000	G-1 Journal Entry #1	TWX from EUSAK authorized dropping of ROK troops to a minimum of 25 per company. (Ref: G-1 Staff Section Report, 2d Infantry Division.)
2.	2130	Opn Dir 2d Inf Div	2d Division (- 9th RCT): To relieve elements of 24th Infantry Division S and W from SARIWON Y3 4065.

23d RCT: 23d Infantry
 ATCHD: 37th FA Bn, Co B, 2d
 Engr C Bn, Stry B, 82d AAA AW
 Bn (SP), Clr Plat, 2d Med Bn,
 Amb Plat, 2d Med Bn, 1 Wire and
 1 Radio Team, 2d Sig Co.

To move to vicinity HAEJU on 21 October.
 Route SEOUL-KAEBONG-KUNCHON-MANGCHONJON-HAEJU.
 Mission to secure port of HAEJU and line of
 communication from HAEJU YC 3813, to CHAER-
 MONG YC 2953 to SARIWON YC 4065, relieving
 elements of 24th Infantry Division in this
 area.

Attachments indicated are effective
 210400 October 1950.

2d Division units remaining in SEOUL to
 prepare for movement to I US Corps zone.
 Public buildings, banks, and other facilities
 of national character containing records
 effecting the military or economic structure
 of the NK Government and NKFA to be secured
 and guarded. Important railway bridges, tun-
 nels, stations, equipment and facilities,
 bridges over streams and isolated signal
 installations to be guarded with troops and
 protected against enemy attack until adequate
 ROK police forces provided by higher head-
 quarters have assumed this responsibility.

Administrative Instructions: One "A"
 and one "B" ration to accompany troops. Veh-
 icles to depart with full tanks plus sufficient
 gasoline to complete trip. (Ref: Opn O and
 Dir File, 2d Infantry Division.)

3.	2400	FOR #228 2d Inf Div	Composition of friendly forces: 2d US Inf Div attached to I US Corps effective 191725 I October 1950. (Info delayed by receipt of report.)
----	------	------------------------	---

The 23d RCT to move to vicinity of HAEJU
 YC3813 - CHAERMONG YC2953 - SARIWON YC4065
 beginning 210600 I October 1950 and relieve
 elements of the 24th Inf ntry Division. Re-
 maining units to prepare to move to I Corps
 Zone. Movement of 23d to commence on 210600
 October 1950.

Reconnaissance party departed 2d Division
 Headquarters at 200915I October enroute to
 I Corps Headquarters.

WAR DIARY

(CSHS-5)

Period: 200001 Oct 50 SECOND INFANTRY DIVISION

202400 Oct 50

Entry No	Time of Action	Authority	Action
4.	1130	G-2 Journal Entry 1846	Report received from EUSAK on progress of TF Indianhead. Friendly information being received on target areas which as yet cannot be interpreted. No report on enemy situation. (Ref: G-2 Journal, 2d Inf Div.)
5.	1530	G-2 Journal Entry 1847	Report from EUSAK TF Indianhead at TARDONG River held up due to engineer construction problem. Elements have reached and secured targets 5 and 8. (Ref: G-2 Journal, 2d Infantry Division.)
6.	1750	G-2 Journal Entry 1854	TF Indianhead reported having found means of crossing TARDONG River with light tanks. (Ref: G-2 Journal, 2d Inf Div.)

Fred J. Meyer
 FRED J. MEYER
 Captain, Infantry
 Division Historian

Period: 210001 Oct 50
212400 Oct 50

WAR DIARY
SECOND INFANTRY DIVISION

(CSHS-5)

Entry
No

Time
of
Action

Authority

Action

SECRET

1. Pers Periodic Report #9 Replacement and returnee gains during this period exceeded losses by a total of 176 men. Losses totaled 106 all of which were non-battle casualties while gains through replacements and hospital returnees numbered 282.

No ROK personnel received during period. Authorization was received to reduce the number of ROKs to 25 per company for a total of 2075 in the Division. Action was taken at the close of the period to effect this reduction.

Awards and decorations - awarding of 17 SSSs, 55 DFCs, 1 Soldiers Medal, 130 BSs, 288 Air Medals have been approved by the A & D Board. Recommendations for 2 CMHs, 3 DSGs, and 1 BS for Air Force Personnel have been forwarded to higher headquarters for approval. To date 77 SSSs, 220 BSs, 1 Army Commendation Ribbon, 306 Air Medals, 55 Distinguished Flying Crosses and 1 Soldiers Medal have been awarded to officers and men of this Division.

(Ref: G-1 Staff Section Report,
2d Infantry Division.)

2. 1600 Cpn Dir
2d Inf Div

Operational Directive published directing the Commanding Officer, 2d Reconnaissance Company to move from present area to SARIWON (YG 4075) area beginning 2204001 October 1950. Upon arrival SARIWON area, report to Brigadier General J. S. Bradley, ADC, 2d Division at 2d Division Advance Headquarters in town of SARIWON for further instructions. (Ref: Cpn O and Dir File, 2d Infantry Division.)

3. 2400 FCR #231
2d Inf Div

Composition of friendly forces: 2d Ron Co to move to pr area 2204001 Oct 50 to vic SARIWON (YG 4075).

Results of operations: 23d Infantry lead elements departed for HANJU 2106001. As of 2115101 the lead elements of 23d RCI had closed in bivouac two (2) miles W of HANJU.

23th Infantry continued reorganization, maintenance of equipment, and small unit training.

Other Division Units continued reorganization and training. (Ref: FCR File, 2d Infantry Division.)

FRED J. MEYER
Captain, Infantry
Division Historian

WAR DIARY

(GSHIS-5)

Period: 210001 Oct 50
212400 Oct 50

SECOND INFANTRY DIVISION

Entry
No.

Time

Action Authority

~~SECRET~~

Action

4. 0700 G-2 Journal
2d Inf Div
Entry 1868

Message received from EUSAK TF Indianhead has secured large number of prescribed targets to include two (2) radio stations. In one station, large amount of new radio equipment and in the other some captured enemy documents. At another target a goodly quantity of enemy documents reported captured but as yet not translated. All reports on TF Targets positive. (Ref: G-2 Journal, 2d Infantry Division.)

Fred J. Weller
FRED J. WELLER
Captain, Infantry
Division Historian

SECRET

WAR DIARY

(CSHS-5)

Period: 220001 Oct 50
222400 Oct 50

SECOND INFANTRY DIVISION

SECRET

Entry No	Time of Action	Authority	Action
1.	1017	G-3 Journal Entry #6	CG 2d Division called CG Division Artillery reference Major Ramsey, 8th Army Air Section enroute to Division Artillery CP to discuss Aviation Light Aircraft. (Ref: G-3 Journal 2d Infantry Division.)
2.	0845	G-3 Journal Entry #8	G-2 received flash report from 8th Army G-2 that friendly forces who were greeted at 220110 hours by citizens of CHINNAMPO now receiving SA, sniper fire, and 40mm AA fire from unknown number of enemy vicinity of port area as of 220720. Sand around port is heavily mined. (Ref: G-3 Journal, 2d Infantry Division.)
3.	1340	G-3 Journal Entry #14	Mission of 23d Infantry changed. Position at present 8-10 miles E of HAEJU. (Ref: G-3 Journal, 2d Infantry Division.)
4.	1520	G-3 Journal Entry #16	Information received from G-4 that 2d Rcn had closed SARIWON. (Ref: G-3 Journal, 2d Infantry Division.)
5.	2400	FOR #234 2d Inf Div	<p>No change in composition of friendly forces.</p> <p>Results of operations: 23d RCT preparing to effect relief of 8th Infantry Regiment. Regimental CP located vicinity of HAEJU, (Y04415). 1st Battalion located vicinity (Y03934). 2d and 3d Battalions located vicinity of (Y03815).</p> <p>36th Infantry regimental CP closed CS 2051 at 221600I. 2d and 3d Bn closed CS 2051 at 222130I October 1950.</p> <p>2d Reconnaissance Company departed at 220400 and closed SARIWON Y04065 at 221355I October 1950.</p> <p>Other Divisional elements continued reorganization and training. (Ref: FOR File, 2d Inf Division.)</p>

FRED J. MEYER
Captain, Infantry
Division Historian

Period: 230001 Oct 50 WAR DIARY (GSHIS-5)
 232400 Oct 50 SECOND INFANTRY DIVISION

SECRET

Entry No	Time of Action	Authority	Action
1.	2000	G-1 Journal Entry #3	TWX I Corp ordering release of all Korean National Police received. (Ref: G-3 Journal, 2d Infantry Division.)
2.	2100	G-3 Journal Entry #4	TWX EUSAK requesting three (3) officers conduct investigation of war atrocities. (Ref: G-3 Journal, 2d Inf Div.)
3.	2400	FOR #237 2d Inf Div	Composition of friendly forces: No change. Results of operations: 23d RGT (-) located vicinity of MAEJU, YC 4415; 1st Battalion located vicinity CHAERYONG, YC 2653; 3d Battalion located vicinity SIWAN-NI, YC 3833. (Ref: FOR File, 2d Inf Div.)

FRED S. MEYER
Captain, Infantry
Division Historian

WAR DIARY

(GSHIS-5)

Period: 240001 Oct 50

SECOND INFANTRY DIVISION

242400 Oct 50

Time

Entry
Noof
Action

Authority

Action

1. GO #78, 2d Inf Div Office of Civil Affairs Coordinator established as a Staff Section of Headquarters 2d Infantry Division, effective 15 October 1950. Colonel John G. Coughlin, O18898, Infantry, Headquarters 2d Infantry Division, announced as Civil Affairs Coordinator, 2d Infantry Division, effective 15 October 1950. (Ref: GO File, 2d Infantry Division.)
2. 0930 G-3 Journal Entry #14 Signal wire chief reported lines to 2d Rcn, 2d RM, 0076 Surg Hosp, three to 8th Army, two land lines through 1st Corps, and 3 VHF lines to Ivanhoe Advance (2d Div Adv). (Ref: G-3 Journal, 2d Inf Div.)
3. 1110 G-3 Journal Entry #16 Division artillery received a request from 37th FA Bn for permission to fire 76mm and 45mm enemy ammunition for practice in the HAEJU vicinity at YC 3910. (Ref: G-3 Journal 2d Infantry Division.)
4. 2400 FOR #240 2d Inf Div Composition of friendly forces remains unchanged.
- Results of operations: 23d RCT, two (2) squads, 1st Battalion relieved elements of 3d Battalion, 19th Infantry at Radio Relay Station YC 3974, Benchmark 480, CHONGSOM-SAN.
- Other Divisional elements continued reorganization and training. (Ref: FOR File, 2d Infantry Division.)

Fred J. Meyer
 FRED J. MEYER
 Captain, Infantry
 Division Historian

Period: 250001 Oct 50 WAR DIARY (CSRIS-5)
 252400 Oct 50 SECOND INFANTRY DIVISION

Entry No	Time of Action	Authority	Action
1.	0100	G-3 Journal Entry #2	25d Infantry to send out a reinforced rifle company patrol at 250700. (Ref: G-3 Journal, 2d Infantry Division.)
2.	1020	G-3 Journal Entry #12	Task Force Edwards departed 0655 from 25d Infantry area. (Ref: G-3 Journal, 2d Div.)
3.	1057	G-3 Journal, 2d Inf Div Entry #13	25d Infantry reported that at 1000 hours Task Force Edwards proceeding W from objective. (Ref: G-3 Journal, 2d Inf Div.)
4.	1722 1800 1805 1845 2040 2115	G-3 Journal Entries 17, 19, 21, 23, 28, 29.	Series of messages to clarify status of unit to guard YONGDONGPO railyard and area of authority. L Company of 38th Infantry assigned responsibility. Company to guard entire railyard. (REF: G-3 Journal, 2d Infantry Division.)

Frank J. Meyer
 FRANK J. MEYER
 Captain, Infantry
 Division Historian

WAR DIARY

(CSRHIS-5)

Period: 260001 Oct 50
262400 Oct 50

SECOND INFANTRY DIVISION

Entry No	Time of Action	Authority	Action
1.	0947	G-3 Journal Entry #15	Message received from Assistant CG at Advance CP for liaison section of 2d Rcn Company to revert to his control at Present Locat on as soon as possible. (Ref: G-3 Journal, 2d Infantry Div.)
2.	1000 1015 1030	G-3 Journal Entries 17, 20, & 21	Call received from 38th Infantry informing G-3 that 35 people caught looting train at YONGDONG'PO and requesting what action to take. G-3 indicated a call would be placed to 8th Army. Eighth Army called at 1015 by G-3 and informed that 8th Army MPs will call back. At 1030 call received that detachment dispatched to pick up captives. National Police assured Army that Koreans captured will be tried and executed before night fall. (Ref: G-3 Journal, 2d Infantry Division.)
3.	1032	G-3 Journal Entry #22	38th Infantry called by G-3 and given information on handling of looters. (Ref: G-3 Journal, 2d Infantry Div.)
4.	1210	G-3 Journal Entry #24	Call placed to Advance CP ordering movement to PYONGYANG. Reconnaissance Company to move with Advance CP. TF Indiamhead to remain also. (Ref: G-3 Journal, 2d Div.)
5.	1700	Ogn Dir 2d Inf Div	2d Infantry Division to revert to Army reserve in place; move to, occupy, and secure Army area; assume control of 187th Airborne RCT vicinity PYONGYANG upon its release from 1st US Corps; provide engineer maintenance and MP control on MSR from NAMCHONGJOM BT 7246 through SOHUNG BT 5560 - SARIWON YC 4064 - HWANGJU YC 4183 and PYONGYANG YD 3920 N to 1st US Corps boundary. Assumption of civil affairs responsibilities for HWANGHAE Province and that portion of PYONGANRANGDO Province lying within. Continued transportation support to 1st US Corps. 187th Airborne to occupy and secure airfields E of PYONGYANG. 9th RCT: Occupy and secure city of PYONGYANG YD 3920; secure bridges and patrol MSR from 1st US Corps rear boundary S through CHUNGHWA YD 5204 - HWANGJU YC 4183 - SARIWON YC 4064. Move one company to vicinity CHUNGHWA YD 4204 and one company to vicinity HWANGJU YC 4183 by organic transportation 28 October 1950. Release company "A", 2d Engineer (C) Battalion to parent organization upon arrival of 2d Engineer (C) Battalion (-) in SARIWON area. Representative to report to Colonel Collier, Deputy G/S EUSAK Advances, PYONGYANG for special instructions concerning guarding of vital installations in city of PYONGYANG. Patrols within zone.

WAR DIARY

(CSHIS-5)

Period: 260001 Oct 50
262400 Oct 50

SECOND INFANTRY DIVISION

Entry of
No Action Authority

NET

Action

Entry #5 Continued:

23d RCT: To remain in present position moving one Company to vicinity NAMCHONJON BT 7246 by 28 October 1950. Secure bridges and patrol MSR from HAEJU N through SIMWON-RI YO 3932 - SARIWON inclusive, and E from SARIWON through SCHUNG BT 5560 - SIMMAK BT 5856 - NAMCHONJON BT 7246 inclusive. Release Company "S" 2d Engineer (C) Battalion to parent organization upon arrival 2d Engineer (C) Battalion (-) in SARIWON area.

35th Infantry (-): Remain in present position, continue present missions and be prepared to move to designated zone of responsibility on order.

2d Division Artillery (-): Remain in present position continuing present mission. C3, 2d Division Artillery, to assume command of all 2d Infantry Division units remaining in SUWON-SAGUL area 280400 I October 1950.

2d Engineer (C) Battalion (-): To move from present location to vicinity SARIWON YO 4084 27 October 1950. Twenty-five additional trucks to be made available for move. Engineer maintenance to be provided on Army MSR from NAMCHONJON BT 7246 through SCHUNG BT 5560, SARIWON, KWANGJU and FONGYANG, N to 1st US Corps rear boundary and that portion of 2d Infantry Division MSR from SARIWON to HAEJU. Provide water supply points within Army area as directed by Army Engineers.

Task Force Indianhead: Task Force dissolved 251200I October 1950. All units to rejoin parent unit on orders this Headquarters.

2d Reconnaissance Company: Move from present location to vicinity FONGYANG. Upon arrival to report to Assistant Division Commander, 2d Infantry Division for further orders.

Logistical Support: Supply (effective 27Oct 1950):

Class I and III: YONGDONG'FC SS 1453: 36th Infantry, Det 702d Ord Co, 2d Div Arty (-), Det 2d Sig Co, 72d Tr Bn (-), and Div Rear.

HAEJU YO 3714: 23d RCT, Div Hq, 2d Engr C Bn, Sig Co (-), 702d Ord Co (-), 19th Ord Co, 2d Med Bn (-), 2d Recon Co, 1076th Mobile Army Surgical Hospital, and 2d RF Co.

FONGYANG YO 5820 (Airlift Supply Base): 9th RCT, 107th Airborne RCT.

WAR DIARY

(CSHS-5)

Period: 260001 Oct 50
262400 Oct 50

SECOND INFANTRY DIVISION

SECRET

Entry No Time of Action Authority

Action

Entry #5 Continued:

Class II and IV: YONGDUNG'PO initially for all units.

Class V: INCHON BS 9550 initially for all units.

Evacuation and Hospitalization: Units in SEOUL area: Through 1st Clearing Platoon, vicinity ANYANG-NI, thence to 4th Field Army Hospital, ABGOM City.

Units in PYONGYANG-HAEJU area: Through clearing platoons in respective areas, then to 8076 Mobile Surgical Hospital, vicinity SARIWON.

Division Headquarters closes NORIYANG-NI CS1652 280400 and opens vicinity PYONGYANG MD 3920 280400 1 October 1950. (Ref: Cpn O and Dir File, 2d Infantry Division.)

6. 1928 G-3 Journal Call received from 8th Army reference move to PYONGYANG on 28 October. 8th Army informed CG Division Artillery in command of units left in area to include 38th Infantry. Informed that 1st and 2d ROK ran into opposition of CHINESE Reds. (Ref: G-3 Journal File, 2d Infantry Division.)
Entry #37
7. G-3 Journal Ron Ln Officer to depart for PYONGYANG at 270700 with LN convoy. Ln Off has been notified. (Ref: G-3 Journal, 2d Inf Div.)
Entry #44
8. G-3 Journal Call from Advance CP reference patrol to CHONGYON. Advance CP to move morning of 27 October 1950. (Ref: G-3 Journal, 2d Div.)
Entry #46
9. G-3 Journal Message received from 1st Corps indicating troops not to cross Line A unless ordered by Corps. Units to notify Corps Hq when Line A reached. (Ref: G-3 Journal, 2d Inf Div.)
Entry #48

 FRED J. MEYER
 Captain, Infantry
 Division Historian

SECRET

WAR DIARY

(USNIS-5)

Period: 280001 Oct 50 SECOND INFANTRY DIVISION

282400 Oct 50

Time

Entry
No

Action

Authority

Action

- SECRET
1. 0400 G-3 Journal Entry #1 Division CF opened vicinity PCONGYANG. (Ref: G-3 Journal, 2d Inf Div.)
 2. 271950 G-3 Journal Entry #4 2d Div Rear reported Hq Comdt and 2d Ron Ln Section arrived 271945. (Ref: G-3 Journal, 2d Inf Div.)
 3. 0940 G-3 Journal Entry #6 Report received from 9th Infantry: Vital installation designated by Colonel Collier secured. Consists of 2 banks and Russian Embassy. Buildings secured approximately 271500I. K Company securing and has CF vicinity of Russian Embassy. E Company cleared IP 280001 enroute HWANGJU. (Ref: G-3 Journal, 2d Inf Div.)
 4. 0800 G-3 Journal Entry #5 Orders received from G3 Hq closes 280400I. Advance Hq to become operational 280400I. G-3 to make report to EUSAK 3 on progress of 9th Infantry as soon as possible. (Ref: G-3 Journal, 2d Inf Div.)
 5. 1000 G-3 Journal Entry #7&8 Vital installations designated by Colonel Collier secured by 9th Infantry approximately 271500I. Relief of 1st Cavalry in progress. 187th Airborne RCT in process of securing airfields E of PCONGYANG. Message received from 187th Airborne RCT: "Recommoitering airfields E and am in process of assuming responsibility. Will initiate relief of 9th RCT on PCONGYANG airfield at 290900I. Cannot relieve them sooner as they have no place to go. Estimated time of relief reached by mutual agreement." (Ref: G-3 Journal, 2d Infantry Division.)
 6. 1130 G-3 Journal Entry #9 EUSAK requested representative of Division G-3 report to G-3 EUSAK relative to guarding an important installation in PCONGYANG. G3 EUSAK anxious to get a report on installation being guarded by 2d Division in PCONGYANG. 9th Infantry directed night of 26 October to report when 1st Cavalry guards relieved. (Ref: G-3 Journal, 2d Infantry Div.)
 7. 1500 G-3 Journal Entries 16 and 17. 187th Airborne RCT informed F&E to be taken over in vicinity G3-18 Map PCONGYANG 1/12500. 9th Infantry advised that at least one company needed to operate F&E on N side of River. Airfield guard depends on amount of cargo coming in. One Battalion there now. PCONGYANG airfield grass strip and can't take much weather. (Ref: G-3 Journal, 2d Infantry Division.)
 8. 1510 G-3 Journal Entry #18 9th Infantry in process of relieving 1st Cavalry of all security missions in PCONGYANG. Guards on Russian Embassy and 2 banks. (Ref: G-3 Journal, 2d Inf Div.)

Period: 280001 Oct 50
282400 Oct 50

WAR DIARY
SECOND INFANTRY DIVISION

(GSHIS-5)

SECRET

Entry No.	Time of Action	Authority	Action
9.	1930	G-3 Journal	2d Medical Battalion CP closed AMYANG-WI and opened PYONGYANG 280630I October 1950. (Ref: G-3 Journal, 2d Inf Div.)



FRED J. MEMLER
Captain, Infantry
Division Historian

WAR DIARY

(GSMIS-5)

Period: 290001 Oct 50 . SECOND INFANTRY DIVISION
 292400 Oct 50

~~SECRET~~

Entry No	Time of Action	Authority	Action
1.	0100	G-3 Journal Entry #1	Instructions received from 8th Army that relief of 8th Cavalry to be expedited. Unit to move N immediately. 8th Army informed that contact has been established with 8th Cavalry and they were unable to inform this organization as to which installations are being guarded by their personnel. On receipt of this information 8th Army stated, "If necessary you can leave installations unguarded for a short period in order to get 8th Cavalry on road". (Ref: G-3 Journal, 2d Infantry Division.)
2.	1735	G-3 Journal Entry #24	187th Airborne RCT instructed to guard and secure bridges across TAEDON-GONG River N of PYONGYANG airport. EUSAK ME's now handling traffic control on bridge. (Ref: G-3 Journal, 2d Infantry Division.)

Fred J. Meyer
 FRED J. MEYER
 Captain, Infantry
 Division Historian

WAR DIARY

(GSHIS-5)

Period: 300001 Oct 50 SECOND INFANTRY DIVISION
 302400 Oct 50

Entry No	Time of Action	Authority	Action
1.	1015	G-3 Journal 2d Inf Div Entry #31	1st Battalion, 8th Regiment, 7th ROK Division attached to 9th RCT effective 291730 for purpose of occupying PYONGYANG. (Ref: G-3 Journal, 2d Inf Div.)
2.	1200	G-3 Journal Entry #45	Message transmitted to EUSAK, "8th Cavalry relieved by 15th FA Battalion at 291200I. 1st and 2d Battalions 5th Cavalry relieved by 3d Battalion 9th Infantry 291600I. Relief of 3d Battalion 5th Cavalry in progress. The additional area assigned to Division necessitated moving several units. E Company 9th Infantry from HWANGJU to CHINNAMPO, EAT 301530I. Remainder of 2d Battalion, 9th Infantry to move to CHINNAMPO and relieve 7th Cavalry upon receipt of transportation. Company B 9th RCT presently at CHUNGHWA and being relieved by company of 187th Airborne RCT. 187th Airborne RCT to patrol MSR and assume responsibility assigned by current operation directive." (Ref: G-3 Journal, 2d Infantry Division.)
3.	1320 1415 1425	G-3 Journal Entries 47, 50, & 52.	In answer to queries from the 187th Airborne RCT and 9th Infantry orders issued clarifying status of FWEs N and S of TAEDONG River. The 187th Airborne RCT responsible for FWE S of River and to assign company size unit to guard and operate. Commanding Officer of this company to be FWE Commander. This officer to be completely responsible for operation but still under command of RCT. Requests for advise and technical personnel to be made to Division FM. These instructions in accordance with desires of EUSAK FM and EUSAK G-1. Similar instructions issued to the 9th Infantry relative to operation of the FWE N of the TAEDONG River. (Ref: G-3 Journal, 2d Infantry Division.)

Fred J. Meyer
 FRED J. MEYER
 Captain, Infantry
 Division Historian.

WAR DIARY

(CSNIS-5)

Period: 310001 Oct 50
312400 Oct 50
Time

SECOND INFANTRY DIVISION

SECRET

- | Entry No | of Action | Authority | Action |
|----------|----------------------|--|---|
| 1. | 302030 | G-3 Journal Entry #70 | Instructions received that 1st Battalion 8th Regiment, 7th ROK Division to be released to parent unit as soon as possible. (Ref: G-3 Journal, 2d Inf Div.) |
| 2. | 0055 | G-3 Journal Entry #20 | Message received from MUSAN (GX26938KGO) relieving 1st Bn 8th ROK Regiment from attachment to 2d Infantry Division. (Ref: G-3 Journal, 2d Inf Div.) |
| 3. | 1100
1125
1130 | G-3 Journal Entries 29, 30, 31, 32, & 33 | Series of communications on relief of 7th Cavalry elements at CHINAMPO. Unit did not desire relief but instructed to go ahead and effect relief anyway. Relief now in process. (Ref: G-3 Journal, 2d Infantry Division.) |
| 4. | 1355 | G-3 Journal Entry #49 | Report rendered to 7th Army on status of units. 187th Airborne RCT dispatched patrol encountering no enemy. 168 prisoners found in possession of ROKs. Whether soldiers or civilians not specified. 187th directed to take prisoners to P.W.E. 23d Infantry patrol to XC 9861, HILL 500 encountered SA and one 76mm gun. Towns in vicinity deserted. 2000 enemy reported in area by civilians. 2d Bn 9th Infantry contacted 7th Cavalry Regiment but 7th Cavalry did not desire relief. However, their 1st Battalion departed this morning. The remainder of 7th Cavalry leaves 0700 1 November. Relief to be completed at that time. 1st Battalion closed at BILPO in SUMAN. (Ref: G-3 Journal, 2d Infantry Division.) |
| 5. | 1605
1630 | G-3 Journal Entry #51 & 54 | Commanding General 7th Army indicated desire for a patrol SUCHON to HANPOK-RI to TOKCHON to TONGMAN to HANSSON and return. Daylight patrol only. This information to be confirmed by radio. Mess Gd will direct also movement of 1 RCT to SUCHON. 7th Army suggested this RCT to be 9th. Orders necessitated by state of confusion of ROK elements to N. Control to rest with Division until ROKs prepared to take over. (Ref: G-3 Journal, 2d Inf Div.) |
| 6. | 1900 | Zero Periodic Report #10 | Replacement and returned gains during this period exceeded losses by a total of 857 men. Losses totaled 1000 of which were non-battle casualties while gains through replacements and hospital returnees numbered 779. |

No ROK personnel received during period. A total of 1055 ROK Troops returned to Korean Army during period per instructions of USMA.

Awards and Decorations: 45 US and 61 SA awarded Division personnel.

WAR DIARY

(CSHIS-5)

Period: 310001 Oct 50
312400 Oct 50

SECOND INFANTRY DIVISION

Entry
Time
of
No Action Authority

SECRET

Action

Entry #10 Continued:

During the period covered by this report, Civil Assistance Teams were operating in the Provinces of PYONGAN NAMDO and HWANGHAE DO. Civil Assistance Team of the 9th RCT, headquarters PYONGYANG, relieved the 5th Cavalry Regiment of Civil Assistance responsibility for PYONGAN NAMDO, and the Civil Assistance Team of the 23d RCT, headquarters HAEJU, assumed responsibility for Civil Assistance in HWANGHAE-DO. On 26 October, the Division Civil Assistance Officer issued general instructions for the administration of civil assistance activities within the Division area of responsibility. Instructions received from EUSAK on 29 October that a Civil Assistance Team from EUSAK was attached 2d Infantry Division for assisting in the administration of Civil assistance in the Province of PYONGAN NAMDO and to insure some continuity in this work when the Division moved on. The 9th Infantry Civil Assistance Team was made responsible for the City of PYONGYANG and its Civil Assistance Officer became the Executive Officer of the Army Team Commander. In both provinces, persons were being screened for suitability for assignment as interim governmental officials. In PYONGYANG, a mayor and bureau chiefs had been appointed by the Civil Assistance Officer, I Corps. In HWANGHAE DO, a provincial governor and bureau chiefs were selected and approved, and City Governments were set up in HAEJU, SARIWON, and CHAERYONG. Surveys were being made concerning amount of food on hand, medical supplies, number of doctors, number of hospitals available and future requirements. (Ref: G-1 Staff Section Report, 2d Infantry Division.)

[Signature]
FRLEY J. MEER
Captain, Infantry
Division Historian

c/s

C/S Daily Log
Item

Action & Remarks

No.	Date	Time	Item	Action & Remarks
1	081330	Sep.	G&S Staff Meeting. No policy change. Keep C/S informed. Visit Units. Do not ask lower staffs to come to Div. All possible assistance to units. Short briefings 0800 daily. Staff to go to CG and/or ADC through C/S. Inform C/S at once of directive by CG direct to Staff.	
2	1430		IG instructed to investigate report that a Sgt of the 9th Inf attempted to surrender a group of Americans to the NK.	ADC terminated investigation due to insufficient facts 091000.
3	1450		G-4 reported approximately 160 SK Police had been directed by EUSAK to occupy, keep in useable condition, and protect the fox holes and dugouts on the permanent defense lines. The Question raised by G-4, who was responsible for their logistical support including furnishing of shelter and clothing. G-4 instructed to explore the problems with Army G-4 and make recommendations based on his findings.	EUSAK states that responsibility is other than 2d Div 11 Sept.
4	1450		G-4 directed to instruct Ordnance not to return to units any of the tanks which they now have physically in the 702d Ord. Co. area or repairs. Reason, tank traffic on the roads under their present condition would tear up the roads. To be used as a reserve, to be used for knocking out road blocks along MSR. Number of tanks present in maintenance company area, 8; 7 for 2d Tk Bn, and 1 from a Regt Tk Co.	Completed
5	1600		Col. Alfred briefed C/S on plan for defense of CP.	Completed
6	1700		Col Alfred instructed to write up Memo on defense of CP. Memo to be distributed throughout CP. Practice defense to be held 10 or 11 Sept.	Draft Memo in hands of C/S 101530 Sept 50.
7	010300	Sep.	G & S Staff briefing.	
8	0830		CG Requested road recon from Maun-ni to Chong-do through mountain passes to defensive positions. Col Alfred to make map study now and Air recon as soon as weather permits. Ground recon to be held in obedience until ordered by C/S.	Air recon 091400 overlay due 101600 Sep.

No.	Date	Time	C/S Daily Log Item	Action & Remarks
	in	out		
9		090845 Sep	G-4 confers with C/S. G-4 now has adequate Ammo except 155 Hw. Train load 155 Hw due in this date. 14 Tks now in 70rd. 5 belonging to 23rd Tk Co. ready to move. Tks to be held until further notice because of road conditions and conflict of traffic of the Div Reserve, north to south. 5 tks moved to Di Sig Co for radio maint. Tks to be held there after repair in Div Reserve. G-3 informed.	G-4 reports 5 cars in as of 101800 5 tks cleared Sig and sent to 23rd as per Sig O 101430
10		0945	ADC recommended current operation order be amended to show that there will be no night time withdrawal from the MLR positions under any circumstances. Unit to stay in position and fight. Day time withdrawals authorized only by CG upon personal recommendation of Regt CO.	To G-3 for action. Completed.
11		0937	C/S OK'd 6 men and weapons to assist on move of VHF station to 26.5-11.5.	To Sig Off for Action. Completed.
12		1010	C/S instructed Pm to prepare a list of required signs to control traffic as per CG's instructions at staff briefing. List delivered to ADE at 1037 for preparation of signs	PM to pick up signs at 120800 Sep 50
13		0920	G-1 recommended to C/S that Maj Stewart, relieved as Bn Com 38th Inf be offered to 23rd and 9th Regt for assignment in other than command capacity. Principal reason stated by CO 38th that Stewart was aggressive, interested, and desirous of doing a good job, but could not coordinate well with others, and while he did not want him as Bn Com he felt Stewart could do a creditable job in a capacity other than command with another unit.	Recommend approval by C/S
14		0920	Command decision was made to move 1st Bn from Ivory Sector to south of Changyong for Div reserve. To be employed on Div Order only.	G-3 informed See item 23.
15		1030	G-4 informed C/S that Lt Hyland had started ground recon of a route over mountains from Maun-ni to Changyong as an alternate for present north route. Air recon to be made as soon as weather permits.	G-4 reports Recon not yet completed 101600 Sep Air Recon set for 11 Sep.
16		1037	G-4 presented C/S memo showing shortage of C Rations (19,000 now at QY no more in sight). 5 in 1 rations to be used on outposts, etc., only when R-1 rations cannot be used. R-1 rations to be used at all times possible.	Draft approved by C/S

C/S Daily Log
Item

No.	Date	Time	Action & Remarks																																								
	in	out																																									
17	091300	Sep	CG approves plan to establish one platoon recon Co with radio and wire comm to Div CP at Kugi-ri (1161-1339). G-2, G-3, H, and Sig informed. Unit to be designated Ivanhoe Larson. At 100800 Maj Becker to start force of 130 SKP w/5 or 6 MP's from Kugi-ri to Kamni (1155-1402). This movement to be coordinated w/movement from other direction by Maj Young w/50 of his force moving on Kamni from the west. Mission of these forces is to destroy small groups of enemy and guerillas encountered and gain information on larger grps. completed.																																								
19	1330		From Index 5. They have no liaison planes in the air for supporting artillery. Request that action be taken to get the Div Air off the ground. Particularly the Arty planes for the supporting unit. Div Air Off to get them off the ground. completed.																																								
19	1540		Ivory reports no SKP now in Changnyong. PM states 30 armed with weapons had been sent up there. PM to check with SKP Chief to determine whether or not SKP are in Changnyong, if not, what steps can be taken to maintain SK's in Changnyong. PM reports that the Changnyong police are in fact back in the city. PM to report to C/S. completed.																																								
20	1410		CG authorized return of 5 tks belonging to Tk Co 23d Inf to Changnyong area. G-3 instructed to study feasibility of tying strings on C Co 72d Tk Bn in Changnyong area to prevent employment by 23d Inf except on Div Order. Completed.																																								
21	1410		Reference request by 2d Engr to displace H&S Co disapproved by CG. Engrs to remain in present position, improving hard stands to fullest extent possible. Completed																																								
22	1630		Check radio comm between Engr Bn and 10th Inf CP. Possibility of using CG's command car. notify Engrs of their present nets 101920 Comm set up and working.																																								
23	1700		Decision by CG to hold in obedience the execution of the order which would move one Bn from Task Force Haynes to the Changnyong area in Div Reserve until further notice. See item 14 completed.																																								
24	1730		<table border="0"> <tr> <td><u>Tks.</u></td> <td>2 fr 23rd Inf</td> <td>-</td> <td>RFI</td> </tr> <tr> <td></td> <td>8 fr 72d Tk Bn</td> <td>-</td> <td></td> </tr> <tr> <td></td> <td>1-M26</td> <td>-</td> <td>RFI</td> </tr> <tr> <td></td> <td>1-M26</td> <td>-</td> <td></td> </tr> <tr> <td></td> <td>1-M4</td> <td>-</td> <td>RFI on 10th</td> </tr> <tr> <td></td> <td>1-M26</td> <td>-</td> <td></td> </tr> <tr> <td></td> <td>1-M26</td> <td>-</td> <td>RFI on 11th</td> </tr> <tr> <td></td> <td>1-M26</td> <td>-</td> <td>RFI on 12th</td> </tr> <tr> <td></td> <td>1-M26</td> <td>-</td> <td></td> </tr> <tr> <td></td> <td>2-M4</td> <td>-</td> <td>In about a week, lack of parts.</td> </tr> </table>	<u>Tks.</u>	2 fr 23rd Inf	-	RFI		8 fr 72d Tk Bn	-			1-M26	-	RFI		1-M26	-			1-M4	-	RFI on 10th		1-M26	-			1-M26	-	RFI on 11th		1-M26	-	RFI on 12th		1-M26	-			2-M4	-	In about a week, lack of parts.
<u>Tks.</u>	2 fr 23rd Inf	-	RFI																																								
	8 fr 72d Tk Bn	-																																									
	1-M26	-	RFI																																								
	1-M26	-																																									
	1-M4	-	RFI on 10th																																								
	1-M26	-																																									
	1-M26	-	RFI on 11th																																								
	1-M26	-	RFI on 12th																																								
	1-M26	-																																									
	2-M4	-	In about a week, lack of parts.																																								

No	Date Time		C/S Daily Log Item	Action & Remarks
	in	out		
25	0917	1700 Sep	Task Force Haynes reports to C/S that they need hand grenades, 60mm mortar shells, 155mm illuminating shells, 155mm white bags. G-4 states that all items are available at Army supply point and that Task Force Haynes will be supplied.	completed.
26		1700	Task Force Haynes reports Northern MSR needs repairs and maintenance due to present condition. G-4 recon by Engrs as of 7 Sep indicates good condition. Road recon to be conducted 10 Sep with view of providing necessary technical supervision and hiring native labor to complete necessary repairs.	Engrs ordered up again 101400. No positive action yet.
27.		100845	CG will receive Col. Hill anytime before noon.	Sees CG 10 Sep.
28.		0845	C/S directs Engrs to make recon of Naktong river on our southern flank to determine how much of an obstacle it is to cross by force by enemy. Dozer tanks mired in south of Kyun'Gyo, CG wants to get them out. Engr to coordinate with G-3 on that	See item 37 completed.
29.		0845	CG wants some kind of cat-walk or bridge across stream in the CP area so men won't have to wade. Hq Comdt given task with Engr assistance.	Completed. See item 38.
30		0845	C/S sees Col. McEachern, Hq Comdt, and Maj DuVall.	
31		1220	As a result of a personal visit of the AFC to the CG and Staff, following decisions were made: 1. to send 200 ROK troops now assigned to the 9th Inf to the 23rd Inf. 2. to send 4 Co Grade Officers from Hq staff sections to the 23rd Inf with the ROK soldiers for assignment to the 23rd. 3. to have G-1 levy all service units, including Hq Co for 1/4 of their men and appropriate number of company grade officers. These to be made into a packet for assignment to Inf Repts, preference to 23rd.	This to be accomplished by noon tomorrow. 110700; packet of 75 from Hq etc set up for 23rd leaving 1330. completed.
32		1530	Sig Off recommended that the wire team with the 8th Inf and the 23rd Inf be combined under the Sig Off at Divarty in order to service all three combat elements more effectively. He intimated that wire team with the 23rd Inf was not being used to best advantage under the present condition and that at times they were being used as Infantry.	Completed.
33		1330	Directive to G-3 to study: 1. withdrawal of the northern units of the 38th Inf to a position which would shorten their lines and still block principal approaches to the northern MSR. 2. Utilization of the 1st Bn 9th Inf to help back up the 23rd Inf just south of Changnyong.	

C/S Daily Log
Item

No	Date Time in out	C/S Daily Log Item	Action & Remarks
34	101530 Sep	Col Burnes, G-3 Air EUSAK, just called and said that as of 1330 today we were getting 34 air sorties. He indicated that in the overall picture we had rather a low priority. However, whenever we picked up air targets by getting the request in to JOC we could get a strike on the target within a very short time.	To look into manner in which G-3 air puts in their requests. To insure prompt action on the delivery of air strike
	1540	C/S instructs G-3 air to file daily a request for air strikes for the following day. This request to be based on reports from G-2 and 3 sections as well as requests by G-3 air from the Artillery aerial and ground observers. G-3 air to request all suitable air targets without regard to priority of JOC of air support to Div. All targets are to be reported in an effort to receive maximum air support based on available targets rather than established priorities. G-3 air to keep record of number of written requests sent to JOC and actual number of missions flown.	
35	1630	Check Sig Off on repair of TACP radios. Check air liaison Off to obtain assistance. Check use of Navon air craft. Make sure that all of our air craft are utilized to maximum extent. CG has placed his liaison aircraft at disposal of G-3 and/or G-2 at times when he is not using it.	AF equipment-Sig can effect little repair.
36	1920	Col. Alfred to see C/S at 11000 Sep.	
37	2035	Report submitted to C/S not conclusive. Col McEachern asked to restudy and come up with a conclusion as to whether or not river is an obstacle to crossing in force by the enemy without bridging, assist such crossing. Also to investigate feasibility of getting tanks out of present position.	Div Engr notified of requirements at 2235. Completed-See 4). 2 dry days needed prior to getting tk dozers out.
38.	2035	Div Engr to assist to improvise foot bridge rather than present float across stream to CP defense area. To consider more centralized location of bridge than present site.	Bridge in vic of first float. completed.
39.	2035	G-2 and 3 directed to keep field grade off on duty in combined section for 24 hr period. The period 2200 to 0700 to be divided between field grade off of these sections.	Completed.
40	2035	Col Sloane reports that a patrol, having some SK and a half track started prior to dark to investigate presence of NK's in hills back of Yongsan. The SK's in the patrol were used as a base of fire while the maneuver force went around a flank to trap the NK's in civilian clothes who were filling canteens. As the	110'00 PM rpts trapping delay until daylight today. See Sanl Flush item 60.

No	Time Date in out	C/S Daily Log Item	Action & Remarks
40-continued.		<p>trap was about to be sprung, the SK's opened fire, but in the direction of the maneuvering force, rather than in the directions of the NK's. Col Sloane is not prepared at this time to think that this was a deliberate action on the part of the ROK soldiers, but definitely feels that the ROK's should have ROK non-coms and more interpreters.</p> <p>C/S directed PM to send 6 MP's and 28 Korean police with interpreters to Col Sloane at the 9th Inf CP at 110330. Unit then to be supported with half track and other troops from Index to set the trap again.</p>	
41	102015 Sep	<p>BM reports that 150 Volunteer students have been set up to lead grps of refugees from Vic of police sub station (1161-14.0) via trails and off main roads as much as possible, past Maun-ni to Susan-ni.</p>	<p>7 actually reported Ref moving slowly quite extended, had of grp vic Maun-ni.</p>
42	2100	<p>G-1 reports 160 ROK's from Index for Inspire are now in the Inspire trains area and will move forward in the morning.</p>	Completed.
43	110700 Sep	<p>Decision was reached that Task Force Haynes would release the TACP in the area today to Inspire. G-3 notified for necessary action.</p>	<p>Reconsidered. See item 45 below.</p>
44	0753	<p>G-2 reports 8 POW's report 1000 enemy, said to be impressed SK soldiers, 1 to 18 yrs old, ready to surrender in the 23rd Inf Sector. G-2 authorized to use leaflets and PA system to attempt to affect surrender.</p>	<p>Air Strike. PA system ineffective. completed.</p>
45	0800	<p>CG confirms, following recommendation of Air Force liaison Off, that the TACP party in the North Sector remain in Ivory CP to direct strikes in both 23rd and 8th sector rather than moving TACP to 23rd.</p>	Completed.
46	0800	<p>CG informed Scotch 5, Col McLennon, of urgent need for return of Index Blue or another equal element for employment in Div Sector. Also informed Scotch 5 of urgent need for additional TACP. Scotch 5 will do all in his power to comply with the request.</p>	Completed on TACP
47	0812	<p>G-1 informed CG and C/S that 75 men from CP H₁, QM, and Ord with available company grade off will be sent to Inspire today.</p>	<p>11150 20 EV from H Co departed. 6 total sent fwd.</p>
48	0830	<p>C/S requested 1 TACP be sent to Inspire as soon as possible from Col Burns (Scotch G-3 Air). Col Burns promises to do all possible.</p>	TACP complete.

No	Date Time		C/S Daily Log Item	Action & Remarks
	in	out		
49	110900	Sep	Div Engr advised in more detail of requirements of Naktong River Recon. Div Engr reports that 2 days of dry weather will be required before the Tank Dozers can be moved out of present mired down positions.	Completed. 13 Sep: Div Engr reports dozers dis-lodged, 1 dozer needs repairs.
50	1205		Col White, Exec Off for Col Burns, called and asked status of our TACP's. He was told that we are authorized 4 TACP's and that we have had only two until this morning when a third TACP reported in. Also informed that each TACP is authorized two each SCR 522 radio, that we have had trouble keeping one now available to each party in service and that we urgently need the allowed two per party. Col White stated that they did not yet have an answer but were working on the problem and that they would contact 5th Air Force reference necessary radios.	Complete, TACPs & Radios sent fwd 11 Sep.
51	1557		Col White called and said that a TACP would be sent to Div CP today, and such radios to bring the Div up to strength.	Completed.
52	1630		TACP party with radios reported into Div CP at 1630. G-3 sent detail of one Off and several EM to conduct the party to Ivory H ₂ where they will be checked out with the unit. The new party then to go to the party to Inspire Inspire, the Party now at Ivory to go to Impel.	Completed.
53	1830		EUSAK G-1 stated that 1-Lt Col to be shipped out of Tokyo 11 Sep, due here in 2 or 3 days for Bn Commander vacancy. Also offered a Major DSC if he could have a Bn and be promoted. CG decides to take the Lt Col but not the Maj. G-1 so instructed and will inform Army G-1.	Completed.
54	1930		Col Teter called C/S and said that 23rd had ordered return of 15 men from the Inspire Personnel section rear to the forward echelon. The 15 men were with Maj Strom and would result in a corresponding decrease in that force. decrease in that force. Action to G-1, authorized return of 15 men from 23rd Personnel Section at Miryang for out shipment to forward echelon 12 Sep.	Completed.
55	2000		PM reports that results of raid (item 40) was 9 enemy KIA and others driven into C Co, 23rd, were 1 Off and 17 men were captured. The Off reported that he had been with his grp of 500 for several days but that this grp as well as another Regt was scheduled to attack Changnyong at 2200 this date. It is believed that the situation has altered to such an extent that no attack will actually take place.	23rd has been notified of this information.

C/S Daily Log
Item

No	Date Time	in out	Item	Action & Remarks
56	121430 Sep		Col Connely, Army G-1, is assigning one Lt Col arriving from Tokyo to the 2d Div as a Bn Comdr. Maj Blair, who was offered yesterday, is being assigned to the 25th Div. Col Connely said that a Lt Col Walton, who has had combat experience and whom he feels to be a good man, has been with the 25th Div for 3 days. Col Walton is being made available to the 2d Div if we will take him. The 25th Div is willing since they especially want Maj Blair. Col Connely indicated that Col Walton was not a cast off and further that he would like an answer this afternoon.	Lt Col fr Tokyo to come to Div. Col Walton turned down.
57	1430		Div G-1 has only 1 man actually available out of 13 to receive awards. The one man present is due a bronze star. G-1's understanding was that the CG wished to make awards at Index this afternoon. In view of the above, it is not believed sufficient reason for the CG to make a trip to Index for award purposes only.	No awards made at Index this date.
58	1430		Col Butler, Army G-3, will arrive at Div CP by air between 14 and 1500 today with a "heavy package" for Div. Lt Carly to meet Col Butler at the Air Strip.	Col Butler in about 1600.
59	1430		CG Section has erected a flag pole, and with assistance of Hq Comdt, scrounged a flag. Suggest flag raising ceremony complete with General Staff, MP's and PIO photog.	Set for 130715. Flag raised at 130715.
60	1430		A PW Lt flushed by Sani-Flush, indicated that there are 200 NK's in hills who want to surrender. G-2 has arranged for test run on this grp using PA system. Wounded Lt to give prepared speech and patrol fr Index to assist in attempt to affect capture. Set for 1500 this date.	Completed.
61	1600		EUSAK operation Order No 10 brought in by Col Butler discussed in order with C/S and CG in general terms with Col Butler.	Completed.
62	1900		C/S briefed G Staff and their assistants on EUSAK Opr Order No 10. Planning tent to be ready morning of 13 Sep. Planning staff designated by C/S	Tent ready 130600 Completed.
63	2000		Col Connely, Army G-1, informed by C/S that Div will accept the Lt Col arriving from Tokyo. Lt Col Walton of the 25th Div turned down.	See item 56 Completed.
64	2020		C/S instructed G-1 to prepare letters of commendation to units of company size or larger for CG's signature. To be in recognition of exemplary action of units.	Completed.

No	Date Time		C/S Daily Log Item	Action & Remarks
	In	Out		
65	122100	Sep	G-2 inquired as to whether Di received 3 copies of EUSAK Opr Order No 10 as listed on distribution. This question for safe guarding copies actually received.	C/S signed for 2 copies only. G-2 informed.
66	130630	Sep	Col McEachern requested to furnish C/S complete information of bridging materials available.	See item 74
67	1330		C/S directs the 9th, 23rd, and 38th Regt Comdrs and CG DivArty to meet with the CG and Staff at the Div CP at 1700 hrs, 13 Oct.	Completed.
68	1345		C/S confers with Sig Off about laying telephone lines.	
69	1350		C/S directed Hq Comdt to make available sleeping quarters for the Regt Comdrs and CG DivArty and also make arrangements for hot water etc.	Completed.
70	2000		Regt Comdrs briefed on preliminary plans for Opr Order 10. Study and discussion followed the briefing.	
71	140645	Sep	Regt Comdrs and Div Staff reviewed execution of Opr Order 10. Plan is firm and Opr Order to be published this date.	Completed.
72	0845		C/S talked with Col Boone, Scotch 3 exec, requesting information on ETA of Index Blue. Col Boone states that a change in the operations order which has not been received by Ivanhoe calls for Index Blue to go into Army Reserve at Samnangjin. The presently with Index Blue to remain attached, Arty to return to Div. C/S requested expediting receipt of changed operation order.	
73	0900		Investigation of Deer Shooting incident vic of Div CP by Col Alfred, sent by C/S to CO 9th RCT through G-1.	
74	0930		Col McEachern states that the 2d Engr has sufficient bridging to construct 330 ft of 35 ton bridge with approaches or 135 ft of 50 ton bridge with approaches and in each case, two end sections would not be used. It would, therefore, be possible to build 2 shorter bridges with the bridging material available. This is the Div Floating Bridge which is supported by pneumatic floats. Col McEachern further stated that assault boats would be needed for working on the bridge, and that all (13) boats had been shipped to the 114 Engrs. A utility power boat is still available and has 6-22 horse outboard motors.	

No	Date Time in out	C/S Daily Log Item	Action & Remarks
75	141300Sep	Col McEachern reported that road repairs has been completed on one spot on Northern MSR, location unknown. Report that ford on northern MSR needed repairs, investigated by Engrs and was determined to be in good condition, however, found that vehicles did not sufficiently reduce speed and thus reports were received that the ford was in poor condition. No work was done on the ford. It was further stated that S-4 Divarty had requested the Engrs to remain in Divarty area for about 3 weeks to do road repairs and/or other Engr work. This request went to G-4 thenight of the 13th and was turned down. Engr repair unit has returned to Engr CP.	
76	1300	Meeting at 1600 for G and Special Staff.	Canceled.
77	1425	G-3 representative, Lombardo, informed C/S that General Parsons, General Timberline, and Colonel Grippin would visit the CP at 1450.	
78	1935	C/S instructed two sections of 82AA for protection of CP at next moving. C/S also cautioned Ivory to be alert throughout the sector for possibility of enemy activity. Ivory notified that Div CP move had been deferred until further notice.	Completed.
79	1945	C/S inquired G-4 as to whether or not Engrs were alert in planning for river crossing. Planning to include locating and/or stock piling timbers, sand bags, straw rico bags, wire, and other bridge material or bridge material expediant.	Completed.
80	1945	C/S questioned G-4 as to progress of providing distinctive markings for SK soldiers to distinguish them from NK's. G-4 reported that 2d Div patches are being issued to be worn by SK line troops only, one patch on each shoulder. G-4 cautioned that supply of patches was limited and would require control to insure adequate supply.	Completed.
81	2000	Hq Comdt informed C/S proposed CP area will be ready by noon, 15 Sept.	Area ready per schedule.
82	2045	2d Engr reported 1 Off in M. Ryang to determine what bridging materials were being made available to the Div. Reports that Engr S-4 will stop in CP about noon 15 Sep for more detailed report.	Completed.

C/S Daily Log
Item

No	Date Time	in out	Item	Action & Remarks
83	151040Sep		Index 5 called stating that Inspire had sent a Company size unit forward to gain high ground. This unit could not maintain its position nor was it in supporting distance of adjacent units. It was being attacked on two sides by small arms fire. They requested permission to either pull back or commit a company of Blue Bn. C/S informed Ivory 5 that Inspire Blue would not be committed, but that if it was necessary the unit could be pulled back to its former positions.	Completed.
84	1135		Index 6 reports to C/S following strength by actual nose count: F Co. 61 white 57 ROK; total 118; E Co. 61 white 39 ROK, total 100; G Co 58 white 38 ROK; total 96; Total count for B Co 118. No other figures available at present.	
85	1140		Impel 6 requested from C/S assignment of Engr Co to assist in movement of tanks. Impel 6 also asked that release of units now with Inspire be expedited. C/S informed Impel that Engrs would not be available unless Index Blue returned to Div control, and also that return of units to Impel would be expedited.	Completed.
86	1145		Impel 5 called C/S and requested air strike, especially napalm for Hill 208 coordinated with attack, 16 Sep. C/S informed Impel 5 that every effort would be made to assist. Impel 5 also requested assignment of photog for publicity purposes. Photog to report to Index and Inspire.	Completed.
87	1250		Invent 6 briefed by C/S on overall picture and Engr part therein. Invent 6 informed that all instructions while Invent is Div reserve would come from G-3, C/S, ADC, or CG. Invent 6 instructed to make necessary preparations to assist in river crossing and to otherwise support the attack, also informed of location for disposition of trps and present mission including protection of VEF Station.	Completed.
88	1630		Impel 5 called C/S requesting that Impel F hour be set by Impel so that hill 208 could be secured prior to launching attack at H hour, also requesting that air strike be provided on hill 208 to insure success of pre H hour attack.	
89	1820		C/S OK's to Impel 6 attack and securing Hill 208 prior to H hour. G-3 air feels confident that air strike can be furnished so that attack on hill 208 will be assured. G-3 air to confirm air strike on hill 208 with Impel 6 prior to 0000 this date.	G-3 informed of this action. Completed.

No	Date Time		C/S Daily Log Item	Action & Remarks
	in	out		
90	151947	Sep	C/S informed G-3 Ivory that harrassing fires of artillery should be increased from about 2200 to 0100 throughout the sector.	Completed
91	2014		G-3 informs C/S that tactical air support in our sector will have priority from 0635 to 0700. Deviation of this plan will be announced by EUSAK by 160400. EUSAK further stated Div to select own H hour. H hour for Div set at 0700. G-3 to inform all units (confirmed by CG).	Completed.
92	2018		G-4 informed C/S that 1 tank for Inspire (90mm) was ready for action but that crew was reluctant to proceed to Inspire. C/S directs G-4 to immediately dispatch tank to Inspire under jeep guide.	Completed.
93	2040		G-3 informs C/S that amphibious landing was made this date 0615. Landing was successful and proceeding as planned. C/S directs that this information be disseminated to all units.	Completed.
94	2210		Inspire requested two minesweepers squads through G-3. C/S directed two minesweeper operators and two other men be sent to Inspire not later than 160600 G-3 informed.	Completed.
95	160745	Sep	CG called Scotch 5, (Col McLennon) and explained that the Div was forced to jump off without pre-planned air support. Div was not able to get definite information that no air support would be available until 0630 and it was then too late to alter time of attack. Failure to be informed that there would be no air available in enough time to delay the hour of attack forced Div units to jump off against opposition which, it is felt, would have been neutralized had coordinated air support been available. This lack of pre h hour air support also resulted in the expenditure of large amounts of artillery ammo which is in critical supply. Scotch 5 was urgently requested by the CG to make available to the Div increased allowances of Arty ammo for reasons stated above.	
96	1050		S-3, 9th Inf, directed to use all means available to take hill 201 which is jeopardizing the attack of Inspire Blue who are now 1200 yds forward. S-3 9th reports patrols in foothills of 201 and that plans are being made to attack 201 using H&S Co elements. G-3 to be informed of time of attack.	
97	1535		C/S contacted Col White, G-3 Air at Scotch, and informed him of people and Arty moving back across river. C/S told Col White that these were lucrative air targets. Col White states that he will do what he can.	Completed

C/S Daily Log

Item

Action & Remarks

No.	Date Time	C/S Daily Log	Item	Action & Remarks
	In			
		Out		
98	161608	Sep	Ivory 5 reports that Inspire 6 states at 1600 Inspire Blue was at the base of the final objective and had every expectation that they would take the final objective due to the withdrawal of enemy. It is anticipated they may not occupy the final objective tonight, but would outpost the final objective tonight, and would hold more commanding ground to the rear. Inspire Red had moved to the forward edge of the finger of their present psn and were tying in with Inspire Blue tonight. Further reported that arty had done a good job and that air was striking many enemy forces trying to cross the river. Further reports Impel is now moving toward Objective 4, that the enemy is pulling out in mass and that air was working them over. Defensive fires for the night are being prepared for Inspire and Impel by Ivory.	
99	1620		Impel 5 reports that objective 3 has been taken, objective 4 is being by-passed and Impel is now going for 5 and 6. Expect to be on the river tonight. Col Peplow in a rea personally leading activities.	
100	1830		Inspire reports plans have been changed. Will hold objective in strength for the night. At objective 3, 1 reserve Co plus 2 Plato ns of Blue. The situation is favorable for that. Blue is way out in front. Red is not so far. White is where they were. C/S instructed that they should consolidate and clean up rear, mop up any enemy they by-passed. Inspire reports that Impel is on objective 6 and is now going for objective 5. Inspire reported they had lost most of their best officers and all officers of C Co. C Co was dissolved. Inspire also reports they have taken about 25 POW's.	Complete d.
101	1340		Index reported that F Co. was moving on hill 201 and enemy was moving off. Index reported that they are sure they will have hill 201 by night.	
102	1845		Ivory reports the following information passed on fr Impel: Unconfirmed that Blue and White are on the way to Objective 5 and 6. Further reports that Inspire says a unit of Impel is now on Objective 6.	
103	1900		CG asked that C/S direct all units to have Tks forward for early morning work. That all units will be instructed to secure objectives, consolidate psns, and mop up 17 Sep. Index to submit plan for operation for 17 Sep.	Completed.

C/S Daily Log
Item

No.	Date Time	C/S Daily Log Item	Action & Remarks
	In Out		
104	161937 Sep	Check with Sig Off reveals that there are no wire comm to Invent Fwd. Col McEachern instructed to send CW message to Invent Fwd instructing them to immediately report their new location vicinity of Changryong upon closing, and that liaison Off be instructed to report to G-3 with exact location of new OP.	Line in 17 Sep.
105	2100	Col Withers, Scotch tank Off, called stating that a radio had come in from DA requesting number of Tks lost through enemy action, number destroyed by friendly troops to prevent capture, number lost due to mechanical failure and reason for such failure. This info furnished for M4A3, M26, and M24. Info to be phoned in as soon as possible and not later than 24 Hrs from now, to C1 Withers, Scotch Rear 646.	G-3 informed of requirement. Completed.
106	2130	C/S called Ivory 5 and requested that harrasing fire for the night include vilages behind enemy lines, especially where enemy has been sighted and those where it is likely that enemy will occury to get out of the rain. Further requested that Index area to be worked over. Ivory reported that this will be passed on to Imort and that the distance to Index makes it difficult for other Atry units to cover Index area. Ivory 5 further reports that Fwd observers report that enemy Arty is on the West side of the river and that Ivory will give priority to locating and destroying such posns in the morning.	Completed.
107	2135	Impel called and stated that ammo trucks and food trucks can't get through to the trps. They are all mired down. Request a company of Engrs to clean the place up. C/S stated he will get OK from CG to release Engrs.	Completed.
108	2140	G-3 instructed to release Engr Co's to Inspire and Impel. Impel to get C Co. and Inspire to get B Co. They are to report to Exec of Regt first thing in morning. Also mine field to be cleared by A Co. 2d Engrs in Ren Area.	Completed.
109	2150	CG OK's 2 Engr Co's to g out in morning to Inspire and Impel. G-3 instructed to contact Engrs and get B and C Co's out in the morning. For them to contact either the Exec or S-3 of Regt.	Completed.
110	2230	APC called C/S and informed him that Index had planned to take red out of the line as Blue went in, but that a very recent conversation w/ Index indicated that he wanted to take White out and use Blue to insure taking hill 201. Planning to take 201 with Blue then turn South across Red front. C/S discussed the above with G-3 who later reported that they also felt that Index Blue would have to be emplyed to insure prompt securing of hill 201.	

No	Date Time		C/S Daily Log Item	Action & Remarks
	In	Out		
111	162240	Sep.	Index 6 called C/S and proposed following plan for approval for 17 Sep: Blue to attack to the north of first objective hill 201, then swinging south west to 2d Objective about 3500 yds south west in vicinity of Changnyong on to hill 311 as third objective. Secondary attack by Index Red was for B Co to attack from present posns north to south along original objective which is the high ground west of first Bn objective. Second objective to be hill 165. Blue is to be employed as a whole unit. White to stay in place to cover Blue advance. Time of attack 171000. Arty coordinated for attack and air request is submitted. Plan approved by Ivanhoe 6, but execution to be on Ivanhoe 6 order only.	G-3 informed. Completed.
112	170930	Sep	Index reported that Inspire Blue had put out mine fields in their sector and they are giving them trouble. C/S asked Inspire if they had someone there who knew where the mines were and could get rid of them. Inspire reported that they would have to get rid of the mines. Inspire also reported that the Engrs have not yet reported there. Inspire also reports that air is still getting the enemy trying to cross the river.	
113		1000	C/S informs Ivory 3 that Col Holden was at Index and asked for Arty support on hill 201 and also a plane or two if they need them. Ivory said they will give them everything they have.	See items 115, 116, and 117.
114		1015	Col Brinsmeade informed C/S that Inspire layed a large number of mines in Index area and gave them a complete overlay of them. Most of the mines removed. Col Brinsmeade said they put tape over the mines that remained and Index decided the tape should come off and we agreed to take it off for them, but they said their men will do it. C/S asked Inspire what they were doing with the enemy equipment they overrun. Inspire informed C/S that their S-2 was talking it over with G-2 at the present time. Inspire informed C/S they are replacing Red with White and moving White back to the left on CG order.	
115		1030	Ivory 3 informs C/S that the 15th FA isn't using all the Arty they have. 15th is in touch with Liaison and plane. It is difficult to find out where they need the support. 15th says they need no support from us.	
116		1035	C/S informed Index 3 that he just got a call from Col Holden and he was calling for Arty. C/S told Index 3 that they have to instruct their people on how to use their FO's. They aren't using them properly. Index has to get the FO's or Co Comdrs on the ball. C/S informed Index 3 that Ivory has a couple Btrys standing by for his use. Index requested air and C/S says he will do what he can.	

No	Date Time		C/S Daily Log Item	Action & Remarks
	In	Out		
117	171100	Sep	Ivory 6 called C/S and wanted to make sure that C/S knew what their position was. They have 16 guns up there ready to fire, but they don't know where to put it. Ivory 6 says they can make it so hot for them that nothing could live. It is just lack of knowing when and where.	
118	2200		G-4 informs C/S that the ponton bridge is at Miryang and ready to roll first thing in the morning. The first serial will leave at 0515, 2d serial at 0715, one platoon of Ord will leave at 0815, 3d serial will leave 0915, adv bunch of wire for Sig will leave at 1115, and Engr H&S at 1230. It will not clutter up the road for the move of the CP tomorrow. G-4 informed C/S that he alerted the medics to move off N route, idea is that that is a long rough haul and he wanted to get them up in Changnyong. There is sufficient troops to be secure there. G-4 also informed C/S that the 72d Trk Trains moved under Weber's orders. They moved into the old mud hole that G-4 moved them out of a week ago. They stuck the first 6 trks that went into the new location. Reubacher was ordered to move against his recommendation by Weber.	
119	181305	Sep.	C/S called Inspire 5 informed him that a planning directive was being prepared for Inspire to be used for planning purposes only. The plan was for Inspire to hold their present position on the river lightly and attack south to seize Hill 174 (1142-1391), second objective Hill 146 (1142-1389). At the same time Index to increase their efforts. Inspire 5 directed to make plans and start recon to give C/S his expected line of departure and time of attack. Inspire directed to execute on Div Order only, and warned that attack might be ordered before dark. Inspire 5 directed that no bridging operations would be executed except on permission of Div order, however, C/S approved crossing of more troops.	
120	1314		Ivory 6 called C/S and asked for clarification of 1st Bn 38th. C/S informed Ivory 6 38th status quo. Control to remain with CO 38th until otherwise informed. However, Ivory to be prepared to take over control of 38th Red. C/S informed Ivory of planning directive given to Inspire and asked Ivory 6 if they could support such an effort.	
121	1320		C/S authorizes 38th to put one Bn across river.	Completed.
122.	1336		Ivory 6 informed C/S that the following is available support of Inspire Proposed Plan. From present pens, two Btrys (12 guns) of 15FA, 1 Btry (6 guns) 503d, and 1 Btry (6 guns) 37th FA. These guns in their present pens can support an attack for 4 or 5000 yds. By shifting 300 mills, 2 more Btrys could also support the attack, 2 Btrys of 37th FA and 1 Btry 503d.	

C/S Daily Log
Item

No	Date	Time	Action & Remarks
123	181400	Sep. in out	Impel 3 informs C/S that each Bn sending 4 Plats across river and in addition, 1 Bn is sending 2 additional squads. No opposition encountered. The penetration is 2000 yds. C/S inquired as to forming a perimeter and staying the night. Impel says that they think it could be done but will talk it over with Impel 6. The Bns have comm with the patrols across the river.
124	1447		Impel 6 called C/S requesting that Red Bn be replaced with MP's or other trps and that Red Bn revert to 38th. Impel 6 states that most of foot trns of 1 Bn have now crossed the river. Urgently need Engr rafts. The river about 100 yds wide, 10-12 ft deep. On cement bridge, 2 spans are gone. One next to approach and one further out. He further states that he needs the bridge to get his equipment across and further states that it could have been built this morning. On far bank of river equipment such as boats, pontoons, canvas were found, but not in sufficient quantities for bridge or raft construction. Feels that outboard motors are needed also. Reports beach and road not too good.
125	1537		C/S called Ivory 5 who stated he had been on Index Blue OP, that the situation was not too good. I Co, led by Col McMains tried to work up from the rear of 201 but were knocked off by SP, Mortar, and grenades. The other two Co's were about 3/4 of the way from the top and not advancing. Further stating that they lost their officers, that more were on their way, but have not gotten there yet. 15-1600 rds were laid on hill 201 today. C/S informed Ivory that planning directive which Ivory was informed of earlier this afternoon had been approved by the CG except the time had not yet been set. Consideration was being given to pre-dawn attack. Ivory 5 stated that they would alert their Inspire Arty Bn Comdr. Further stated that movement of Engrs in Changnyong prevented his appointment with Gen Gradley.
126	1549		C/S informed Inspire 6 that planning directive discussed earlier this afternoon had been approved but that time of attack had not been set. Inspire 6 felt that night attack or pre-dawn attack would not work. Expressed the desire of placing Red Bn in the position held by his White Bn to block any possible enemy advance before moving Red Bn to the attack. It was his feeling that to accomplish this movement precluded attacking before 8 o'clock but that an 8 o'clock attack could well be coordinated. C/S OK'd 23rd's laying on their own Arty and further stated that every effort would be made to lay on air. Inspire 6 stated that the back side of 201 was well occupied to the river bank and it would therefore be necessary to take 201 before taking 174 and 146. This based on the fact that F Co had received considerable fire from trps in this back slope position.

C/S Daily Log
Item

No Date Time
In Out
127 181700Sep

Action & Remarks

C/S called Inspire 5 who stated no patrols had crossed River. Patrols attempted met SA, SP, and mortar fire. Inspire 5 stated that Index had been asked to send a liaison Off up for coordination of attack tomorrow. Further that Ivory 5 was coordinating Index and Inspire Arty. Inspire 6 reported an overlay with Regt boundaries was being Fwd to Div. Boundaries and plan to be coordinated with Index 3. Inspire 6 feels that objective 2 will be the limit of their capacity. C/S informed Inspire that attack may be pushed beyond second objective. Inspire 6 feels first job would be to cut rear of hill 201. It is anticipated that Red Bn will be in White psn by 2100 this date. A Task Force made up of F Co, AAA, and Tk Plat is in psn in vicinity of line of departure. K Co will be in Regt reserve and will be embyed on Regt order only. Anticipated using Marine style, however, request air H-40, to H-10, ad Arty H-10 to H hour.

Completed

128 1710

The following from Impel 3: All of the 2d Bn Impel except vehicles are across the river. F Co on hill 308, E & G on (believed to be) hill 247. Report no fire in this crossing. Further reports Invent 3, 5, and 6 are with Impel 6 for bridge site selection. Blue objective is outposted on East side of river. One Co Blue minus one plat crossed and outposted about 2000 yds in. Index reports 147 prisoners taken. Red Bn reports Arty and Mortar fire and attacks at 2300, 0130, 0200, and 0500. Mortar and Arty throughout the day and movement of trps to the right rear. Impel maintains contact with Red Bn and have comm so that Reports will come in to Regt from this Bn.

129 1725

Index 5 reports that the attack is continuing on hill 201 at present time. C/S informed Index 5 of above info from Inspire. Lial on Off fr Index to Inspire had departed Index 1705. C/S informed Index that air was being laid on with priority to 23rd. Instructed Index 5 to coordinate Arty and again priority to 23d. C/S further directed the 9th Red was to push attack. Index 5 estimates enemy on 201, 1 Bn supported by another. That is two in depth. States that several heavy machine guns, SP, and 120's were spotted. Air had been very active. Index 5 stated that 2 grps of 100 each was re-enforcing hill 201. Arty on these grps resulted in 40 dead in 1 grp, 80% casualties in the other. Index 5 says the attack will continue for the night. C/S suggests holding present sn and saving energy for inserted effort 0800 in the morning. Index 5 reports White Bn almost out off line and moving toward Yong-san 1510. Index 5 states that the situation on hill 201 is stubborn resistance, not build up for an attack, but feels they could attack any time.

C/S Daily Log
Item

No	Date Time	In	Out	C/S Daily Log Item	Action & Remarks
130	181833	Sep.		Index called C/S and informed him that White Bn is in Yongsan and wanted to know whether or not they could stay the night there. C/S informed Index 3 that he will have to contact Scotch and get an OK from them.	Completed.
131	1846			C/S called Scotch and stated 1 Co Index White due at destination very shortly. That the rest of the elements assembled in vicinity of Yongsan and requested they stay there over night and depart for their destination in morning. Col Dabrey OK's this and further stated that CGEUSAK was being queried as to whether or not this unit could stay with the Div. The decision would be forwarded to the Div. Further stated that Air had been instructed to give them every assistance requesting that G-3 give them complete details including time of attack, by message.	Completed.
132	2020			Scotch 3 Called C/S and informed him that Scotch 5 talked to Scotch 6 who stated that 1 Bn 9th was to go back as originally planned planned. Bn minus Co which has already departed is to leave first thing in morning.	Completed.
133	191945	Sep		CG tells C/S to have G-4 get bridging material request into Scotch. CG also tells C/S that Scotch was very complimentary on the 2d Div crossing the river breaking the back of the enemy, and moving the CP.	Completed.
134	1952			C/S instructs G-1 to put out a message to all units of the compliments given by Scotch 6. 38th should have a special letter of commendation.	Completed.
135	2200			G-4 informs C/S that the Army Engr is to be here early in AM. He will land at DivArty strip 0700-0745. G-4 also informs C/S that he is still tryin. torun down the pontoons. Can't find the trks that went after them. The trks were fr the 60th Trans Co which are in direct support to us.	
136	200300	Sep.		Inspire 5 informs C/S that I and K company are across the river, that M should be over by now. C/S informs Inspire that White Bn will stay in blocking psn until further ordered. Inspire 5 informs the C/S that Inspire 6 will be at the river all day.	Completed.
137	1200			Index 5 informs C/S tht they will make the river today. Index Red Bn is now east of Cleck Point 383.	
138	1230			C/S approves DivArty move of CP on condition of final approval of CG	Completed.
139	<u>See next page.</u>				
139	1330			Index 5 informs C/S that Blue Bn is overlooking the river from west crest of hill 311. C/S informs Index 5 that they should try to secure the river crossing.	

C/S Daily Log
Item

No.	Date Time	In	Out	Action & Remarks
139	201300Sep.			Index 5 informs C/S that tks have rounded corner of Hill 206.6. Index 5 also informs C/S that Tks have rounded south edge of hill 311.
140	see preceding page.			
141	1345			Col Cole states that the M-4 floating bridge did not arrive and the earliest that it is now expected to dock in Pusan is tomorrow, 21 Sep. He stated that a colored Engr Bn is being ordered to our area for the purpose of finishing the construction of the permanent type bridge. It will be a matter of days before this bridge can be completed. It is possible to stretch our present bridge equipment to make a temporary bridge by using Bailey equipment as piling, if the water is not too deep. Even this bridge however, will not accommodate the M-26 Tk. Col Cole is returning to Pusan tonight, but he will return tomorrow to meet the colored Engr Bn on arrival.
142	1600			Index 5 called and informed C/S that the Red Bn has gone around corner of check point 403 and the leading elements are at check point 391. They are receiving SP and mortar fire. The Blue Bn is coming through the high ground. C/S instructs Index to butt on by the river tonight. 1st Bn seized river crossing site 10 minutes ago.
143	2000			C/S called Invert 6 and informed him that Maj Zacharle will have complete charge of putting the bridge in. The Engr Bn is at his disposal. Completed.
144	2130			Index 6 called C/S and informed him that there was an underwater bridge at one time at the crossing, but the center is blown out of it, probably from our own bombers. Index 6 is of the opinion that the Boaks used portable treadways to cross the river at night and pulled them out during the day. C/S agreed with Index 6.
145	21100Sep.			Index 5 informed C/S that two platoons of B Co are across. Index 5 also reports Arty or 120 mortars firing on them. No elements as yet across protecting B Co crossing. Some small arms fire on them.
146	1100			Index 5 informs C/S that all Ducks are leaking but one. Trying to patch them up as soon as they can. The enemy is all dug in, well organized, and well camouflaged. Cannot tell where the Arty or mortar is coming from. Air is there but they aren't as effective as they should be. Index informs C/S that the ISR Plat is moving about on their left flank, down to about Agok.
147	1300			Maj Zacharle requests permission to dismantle one of the Tk Rafts. He will not dismantle until the pcs are needed at an approximately 1530. Permission was granted.

C/S Daily Log
Item

No	Date Time In Out	Item	Action & Remarks
148	211400Sep.	Inspire 5 reports that everything is going slow, road is pretty heavily mined.	
149	1500	Maj Zacherle requests permission to use lights tonight. Permission granted by C/S.	Completed.
150	1530	All lines to index are out, wire chief says they take up all lines when they move. C/S instructs Sig Off to instruct the Sig Off at Index to have lines in whether they are moving or not.	Completed.
151	221300Sep.	CG called C/S and informed him that the bridge is now in full operation and that there should be someone to set up the priorities to send units across. C/S informed CG that the 2d Bn 23rd has the priority at present time. CG also informed C/S that there will have to be a parking area near the bridge so the road won't be cluttered up with vehicles.	Completed.
152	2000	Inspire 6 informed C/S that there is heavy resistance on hills 288 and 272 with the adjacent high ground. Estimated a Bn. of enemy on each hill.	
153	1430	General Walker visited Div CP and stayed about 30 minutes. He conversed with C/S and CG.	
154	2000	Inspire 6 informs C/S of their plan of operations for 23 Sep.	
155	230900Sep.	Index 5 called and notified C/S that Index rear CP is closing and will open new CP at 0920.	Completed.
156	1010	Impel 6 phoned requesting CIC team plus Korean CIC. Contacted G-2 in regard to sending CIC team to Impel Hq and action was completed.	Completed.
157	2030	G-4 informs C/S that there is a shortage of 200-300 radios in theater. G-4 also says that to request the radios they need confirmation by the C/S EUSAK. C/S instructs G-4 to request radios even though they will be turned down. G-4 asked C/S whether or not he should remind EUSAK about the Ducks. C/S says not to remind them yet as we have three more rivers to cross. G-4 informed C/S that the 38th is complaining about not getting C or 5 in 1 rations. G-4 informs C/S that if they would request them they would get them.	Completed.
158	240700Sep.	Advance elements of CP moved to new location at Tugong-ni.	

C/S Daily Log
Item

No	Date Time In Out	C/S Daily Log Item	Action & Remarks
159	241130Sep	General Gavon visited CP. Conversed with C/S, CG, and G-3. Departed at 1300.	
160	1400	Rear elements of CP departed for new CP location.	
161	1430	General Coulter visited new CP site at 1430. Conversed with CG.	
162	1545	C/S section completed move to new CP location at Tugong-ni.	
163	2210	Col Berendt called the C/S to inform him that they had a line into Ivory.	
164	250845Sep.	C/S called Ivory 5 requesting that Ivory investigate into the possibility of a closer tie-in between Ivory and Ivanhoe and the consolidation of the two air strips.	Completed.
165	1030	Index 5 report to C/S that C Co had moved into area vic 1120.4-1394.2, but they had not found any of the Bn there they were supposed to relieve, no one but a few of the trains.	
166	1100	Maj Frye directed to place Maj Bell in charge of the bridge at Hyopchon. FM directed to have traffic detail report to Maj Bell at the bridge site in Hyopchon for the purpose of controlling traffic.	Completed.
		FM directed to send traffic detail to clear traffic jam on road between Chogye and Hyopchon.	Completed.
		Sig Off directed to install telephone at the bridge site in Hyopchon and tie it into the Impel switchboard.	Completed.
		38th Infantry directed to proceed to Seattle, thence West toward Kochang. 38th Inf Tks will have priority over the bridge at Hyopchon.	Completed.
		23rd Inf directed to follow 38th Inf heavy equipment across the bridge at Hyopchon, thence proceed north east to the vic on Maechon dong, thence west toward Seattle.	See item 172
		38th Inf will be given priority on road from Seattle to Kochang upon arrival at Seattle.	Completed.
167	1930	Tempest 5 called and stated that Tempest 6 will visit Ivanhoe tomorrow weather permitting. Request L-4 or L-5 to pick Tempest-6 up at 0830, 26 Sep. at Tempest.	Completed.
168	261000Sep	Advance elements of CP moved to new location at Hyopchon.	
169	1200	Capt Nelson, Hq Comdt, informs C/S that it took from 2 1/2 hrs to 3 hrs to get to new CP location.	

C/S Daily Log
Item

No	Date	Time In	Time Out	C/S Daily Log Item	Action & Remarks
170	26	1230	Sep.	Index 5 informs C/S that Index Blue is 3000 yds North of Tacoma in contact with enemy. Index 5 requests mine sweepers. C/S turned down the request for mine sweepers. Index 5 also informs C/S that they are setting up a radio relay station halfway between Hyopchon and Tacoma.	
171		1530		Rear elements of CP departed for new CP Vic of Hyopchon. Arrived at new CP 1830.	
172	1900			Impel 6 informs C/S that one Bn 23rd is between 38th and objective. Impel 6 requests the 23rd to stay where they are until 38th clears.	Completed.
173		1915		C/S instructs Inspire to stay East of Seattle and hold them there until Div Orders.	Completed.
174	1930			Inspire 5 informs C/S that a message was delivered to Inspire and told them to get off the road and let Impel go by. C/S instructs Inspire to send one BCT up to Koryong to destroy any enemy and to seize Koryong.	Completed.
175	2000			Invent 3 informs C/S that they have two men from A Co workin on the MBR that could be sent to Index for minesweeping. C/S says to send them if they want to.	Completed.
176		2145		C/S instructs G-4 to call Cor 3 and get Engrs on MSR from Hyopchon to rear. G-4 informs C/S that a bunch of ammo in the 9th area was blown. Civ Police are to be on lat dump and a dump in the 38th area tomorrow.	Completed.
177	27	1415	Sep.	Ass't Sig Off called C/S to inquire about the movement of the CP. C/S instructed him to send the wire jump team out, but that the date of the movement was not set as yet.	Completed.
178	28	0940	Sep.	C/S called Inspire Red requesting info as to their situation. Inspire Red 5 reports that they have jumped off to take the hill at 20.2-20.2. C/S instructed Inspire Red 5 that patrols going out will clean out any blocks which they encounter and not just by-pass them.	Completed.
179		1320		C/S called Ipana instructing them that IX corps was giving the Div one half a truck Co. C/S directed that Ipana make contact and arrangements for bringing these trucks under Div control.	Completed.
180	29	0900	Sep.	C/S with Section depart CP Vic Hyopchon for new CP Vic Anui.	
181		1200		C/S with Section completed move from Vic Hyopchon to newly located Div CP Vic Anui.	

C/S Daily Log
-Item-

No	Date	Time	Action & Remarks
	In	Out	
182	30	1100	Completed. C/S held staff meeting with the Gen Staff plus the following special staff: Sig, QM, Surg, Engr, and H. Comdt. Projected plans for moving all of the services up and closing rear areas, leaving the 68th in control of the Hyopchon area. The Staff was directed to make necessary arrangements for such. Equip that could not be brought forward would be taken back to Pusan and shipped by water. G-4 was directed to set road priority for all movement with tactical units given preference.
183	01	1450	Completed. C/S with section closed to new CP area at Chonju, 1415 hrs, departed old area Vic Anui 0840.
184		2000	Completed. C/S directs G-4 to have a road recon from Anui to Namwon to Chonju. Purpose, to bring Brockways to Chonju via road.
185	02	0945	C/S confers with G-1, G-4, AirOff and Sig.
186		1000	C/S confers with H. Comdt.
187	11	35	Col McClain called C/S to announce his presence in the Div Area. No. at Impel intends to come to Ivanhoe if possible, tomorrow.
188		1550	Completed. C/S called G-1 directing that they make all arrangements for air transportation for the return of the unit commanders now at Ivanhoe to their respective units upon completion of Staff meeting.
189	03	1045	Completed. C/S called Inspire directing them to set up an air strip as soon as possible. Inspire reported that action was still under way by I Co to crush all resistance in area of yesterday's ambush.
190		1130	Completed. C/S instructs Col Hector to conduct formal investigation of explosion of Ammo truck.
191		1900	Completed. C/S instructs PM to conduct traffic control for the coming moves of the Div units.
192	04	0855	Completed. PM called C/S to report that Lightning Adv Party is one mile south of Chonju consisting of 14 jeeps. C/S directed PM to let Adv party go thru, but to hold up main body.
193		1400	Completed. C/S instructs Inspire to send a platoon to Tempest to investigate report of attack on VHF prty. See item 194, 195, 196.
194	14	30	Inspire 5 informs C/S that Lt Lamden left for Tempest and Maj Russell also went down. Plat will join Lt Lamden at Tempest.

No	Date Time		C/S Daily Log	Action & Remarks
	In	Out	Item	
195	041800	Oct	Inspire 5 informs C/S that Tempest sent a couple Off to recon for a place for a VHF station. While looking around that had machine gun fire and rifle fire at them. The Plat went up and didn't see any enemy, but saw a SK policeman. The SK policeman said he was firing his greasegun in a cave apparently testing it. The Plat will stay up there tonight. Inspire 5 also informs C/S that they sent the I&R Plat to look around up there.	
196		1920	C/S informs Tempest 3 to inform Tempest 5 the report of the Plat sent to clear enemy from the VHF station area.	
197		2000	Maj Taylor, Air Off at Tempest called C/S requesting two planes at 051300 to fly two Off and top secret documents to Taegu. C/S informed Maj Taylor that he will check on our commitments and then call back.	Completed. See item 198 & 199.
198		2005	C/S called Capt Hoffman, Div Air Off, for info on scheduled flights for tomorrow. Capt Hoffman informed C/S that there was one flight only scheduled. C/S instructed Capt Hoffman to have two planes ready at 1300 at the air strip.	
199		2030	C/S informed Maj Taylor that two planes will be ready at 1300 tomorrow.	
200	050940	Oct	Gne Tisler, G-3 Tempest, called C/S and request air transportation for a G-4 man to Army. important G-4 matters. C/S instructed Capt Hoffman to have a plan made available immediately. Capt Hoffman says there will be.	Completed.
201		1110	C/S Called Tempest 5 in regard regard to the 38th RCT going under the control of the 25th Div and requested if possible, that 38th be left under the control of the Div even with the possible problem of supply.	✓
202		1115	Tempest 5 called C/S approving the above request, the 38th RCT will stay under control of Ivanhoe.	✓
203		1140	Tempest called C/S informing him that the Div would stay in this area until time needed to comply with Army orders of going into reserve on the 19th. Tempest requested that C/S give them an estimate of time needed for the move so as to include it in the directive that is to be issued by Corps.	✓
204		2030	Impel 6 requested that their personnel section stay with Sv Co as they are way behind in paper work. C/S says he will take it up with G-1 and get his OK on it. C/S asks if the 24th is out of Chonan. Impel 6 informs C/S that the roads are all cluttered up with their vehicles.	

C/S Daily Log
Item

No	Date	Time In	Time Out	Action & Remarks
205	061035	05 Oct.		Inspire 6 called C/S stating Lt Frazer, who is receiving the BS will be at Div this noon and wanted to know if the CG would like to present the medal. C/S informed Inspire 6 that the CG would present the BS to Lt. Frazer. Completed.
206		1300		C/S instructs the Div Surgeon to make spot checks on the messes for cleanliness. C/S also instructs Capt Touey to have everyone buckup on behavior, police, and to have inspections covering all area. Also to check cleanliness of mess personnel. Spot checks were conducted by Surg and also by Hq CO
207		1630		Capt Hoff Hoffman reported that one of Div Arty planes hit a wire - damage not known, complete report later. Completed.
208	071500	00 Oct.		Lt Curtis, Hq Pers Off, called requesting approval of a flight to Pusan for individual granted emergency leave in the states. Completed.
209	080845	00 Oct.		Inspire 6 called informing C/S that they sent 10 Trks to Chinju for rations, the trks were not allowed to depart until the PM put POW'S on them. The PM put 800 PW'S on 10 vehicle which overloaded them. When they arrived in Chinju they could locate no one who would take the prisoners until three o'clock the next morning. As a result, 4 of the trucks were damaged beyond repair and the others were damaged but not as severely. Inspire 6 requests 4 new trucks and the others fixed up before they make their march. C/S says he will skin the people responsible and see what he could do about getting the trucks. PM gave up 2 of his Trks for 2 of the damaged.
210		1650		Inspire 5 called C/S in regard to Trks requested by 9th Inf. 9th Inf requested 25 Trks. C/S, after conferring with G-4 directed that Inspire would send the 25 Trks. Completed.
211		2000		G-3 Adv requested C/S to remain at Chonju until 0800 day after tomorrow. To send up more of the CP tomorrow, but not all of it. C/S to stay here with small grp until Sloane and Freeman move out. CP to open at Chonan 0800 10 Oct. G-3 informs C/S that there will be an MP at ford at Konju to direct traffic to new location. Completed.
212		090745	00 Oct.	C/S informs G-3 adv that the following people are on their way to new CP location: Surg, PIO, Sig Det, Chap, Reproduction section of G-2, most of Hq Co. C/S also informs G-3 adv that 250 white replacements in Taegu being sent to Nonsan today. Det of Repl Co at Nonsan to pick them up. C/S asks G-2 adv if they have discussed plans about moving Recon Co closer to Area A. G-2 adv informs C/S that those instructions have not been issued. C/S says he will give the orders to Recon. G-2 informs C/S Completed.

C/S Daily Log
Item

No	Date Time In Out	C/S Daily Log Item	Action & Remarks
212	Continued.	that there are no conflicting orders and that Recon should find their own route.	Completed.
213	090925Oct.	Sig Off called C/S informing him that VHF station at Kongju closing out. There will be no comm for about 3 hrs when move completed.	
214	100700Oct	C/S with section departed CP area t Chonju for Div assembly area vic of Seoul. Arriving thereat 1850.	
215	110900Oct	C/S directed that there would be an inspection of personnel and weapons on 12 Oct 50.	Completed, see Item 216.
216	121000Oct	C/S made inspection of section and of the Hq and area.	
217	1300	C/S departed by air for IX Corps Hq on staff matters and functions. IX Cor s located at Taejon.	
218	1710	C/S returned to Div Hq from Taejon.	
219	130800Oct	C/S directed there would be revile and retreat formations while in Div assemble area. G-3 to publish directive.	Completed.
220	1140	C/S directed ass't G-1 to check into the distribution of Stars and Stripes and to take correcting steps to insure proper delivery.	Completed.
221	1130	Maj Rolf from IX Corps 3 Section reported into the C/S stating he was here concerning submission of reports by G-3 and considering final reports to IX Corps before passing from their control.	
222	1140	C/S conferred with Sig Off regarding available radios and operators within the Div in connection with setting up another radio net as a G-2 net. Sig Off will report his findings to C/S.	Completed.
223	1640	CO 9th Inf called C/S to report his arrival in Div assembly area, and the status of the remainder of his unit.	
224	2130	C/S called Index 6 for report of status of Regt enroute by rail, directing Index 6 to keep him informed as to the arrival and condition.	Completed.
225	140930Oct	C/S informed G-1 that Col Francis Hill was referred to KMAG, Col Messinger to be Dputy ADC, and Lt Col Caughlin to be Civ Affairs Off. Also informed G-1 that the Div will not accept any Lt Col's from Army until readjustments are completed within the Div. G-1 directed to prepare tentative list of awards for staff. All staff to be recommended for suitable awards, Legion of Merits, Bronze Stars, and Commendation Ribbon -- not to be slighted.	Completed.

C/S Daily Log
Item

No	Date Time	Item	Action & Remarks
	In Out		
226	141000Oct.	C/S met with the General Staff directing G-4 obtain info on 24 replacement Tks due the Div. The Staff was directed to make study of Tk resources of the Div and make recommendations as to redeployment and assignment, and re-assignment. Two views to be considered in study, first if we get 24 replacement Tks, second if we don't.	Completed.
227	1030	C/S was called upon by Doc Chong and Doc Yon Kim, member of the Korean National Assembly. They brought the gratitude of the National Assembly for the action of the 2d Div in the fight against the Communists, also brought info on the location of NK pockets and other intelligence info.	
228	1100	G-1 and SSO reported to C/S on the status of Special Service functions and supplies, and methods of distribution of the Stars and Stripes. C/S directed that G-1 write letter to Army for Gen Keiser's signature in regard to SS supplies.	Completed.
229	1320	C/S directed G-3 (Naj Swartz) that we would have a formation for the dedication of the flags consisting of the Band, Unit of US, unit of ROK, and unit of UN's. G-3 to draw up schedule for such. Also to make all necessary arrangements for token presentation in conjunction with retreat formation in near future. Also to issue additional orders to supplement Memo on Reville and retreat.	Ceremony canceled because of foul weather.
230	150315Oct.	AG informs C/S that they are behind in the wards section and they could use any additional help available. C/S OK's AG to place the JA Section, IG section on duty with the AG to help in the rewriting of the wards so as to get them out as fast as possible.	Completed.
231	1645	Impel 5 called Ivanhoe 5 requesting air travel for one officer to Miryang to check on storage there. C/S approved flight.	Completed. See item 232
232	1650	C/S called air section directing that a plane be ready for Capt McGowan at 160000.	Completed.
233	160825Oct	C/S, indiscussing personnel matters with G-1 and AG directed that no work would be returned to the units for minor corrections, it will be taken care of by the Div Rear. AG requested that the 38th Personnel Sect be returned to the control of the Div Rear, which was approved and will be directed.	See item 234
234	0900	C/S called Impel 6 directing the 38th Personnel Sect be returned to Div Rear. Impel 6 declining saying that they could do better work with the Regt. C/S goes along with this.	

No	Date Time		C/S Daily Log Item	Action & Remarks
	In	Out		
235	1610	00Oct	C/S conferred with Invent 5 & 6 informing them that they will be prepared to move in the next few days.	
236	1045		C/S conferred with G-1, G-3, G-4, and Hq Comdt, and PIO on presentation formation which will be held at Index on the 18th, also the flag dedication program which is to be held at Div CP on 17 Oct. It was directed that the 3 publish Memo's covering above formations.	Both formations canceled.
237	1710	00Oct.	G-4 reported final elements of QM arrived with 68,000 gals of gas and 36,000 36,000 rations at Suwon. The above will remain as a safety factor, and G-4 will continue to draw all possible from Army.	Completed.
238	1020		C/S conferred with G-1 on proposed list for promotion, also proposed list for awards. It was directed that these be expedited so as to be completed at earliest possible date.	Completed.
239	1808	15Oct.	C/S directs Sig Off to have one PA set in operation condition for use in Div Hq. This set to be maintained by Sig.	See item 242.
240			C/S directs IG to conduct investigation on the value of the ROK's.	Completed.
240	0830		G-1 confers with C/S, says AG can't get much work done since they have to fall out for Beville and retreat every day. C/S OK's for AG to have maximum attendance at least once a week, setting Saturday as that day. G-1 also talks about the forthcoming promotions of Officers.	
241	1530		C/S directs Hq Comdt to hold off for a few days on having the drivers get trip tickets before being able to take a vehicle out of motor pool.	
242	1908	15Oct	Sig Off informs C/S that he has located a PA set that is suitable for the Div Hq use. The PA set is at the Repl Co.	
243	1440		C/S conferred with Dr Chong, who offered fresh milk for Div use. C/S informed Dr Chong that he could not accept it as people of Korea would need more than the Div. Dr Chong also informed the C/S that there will be a National Assembly meeting on 27 Oct.	

C/S Daily Log
Item

No	Date	Time	In	Out	C/S Daily Log Item	Action & Remarks
244	20	1055		Oct.	C/S conferred with G-4 on the investigation of the explosion within the 38th FA area. G-4 recommended that board proceedings be approved. The trks will not be surveyed. G-5 will be given a copy of the board for study in connection with civilians involved.	Completed.
245	21	1100		Oct	C/S called a staff meeting of G and S staff and announced that the scheduled move north was going to be delayed until a later date. When planned move is made, the bulk of the CP will move first day and the minimum operating personnel closing the following day. The staff was directed to make reports to C/S of action taken on all directives received from higher Hq.	Completed.
246		1500			G-4 informs the C/S that a truck-head will be established at Sariwon. There will be 50 Trks, 20 fr the 23rd, 20 fr the 38th, and 10 taken fr other units of the Div. They are to Trk supplies fr Inchon to Sariwon.	
247		1515			Maj Ramsey fr Army Air Sect called on the C/S. He is visiting the Div for the purpose of making a survey and a technical inspection of Div Air.	
248		1530			Col Berendt, Sgt Off, called to inform the C/S that he may contact Gen Bradley by calling thru Scotch to Jackson where the General has an office. The location of Jackson is at Sariwon.	
249	22	0915		Oct.	C/S flew to Pyongyang to I Corps adv H, to confer with Staff there on the operational situation. C/S returned to Div CP 1740 this date.	
250	23	0830		Oct	C/S conferred with G-1 and G-4 in regards to the needs of TF Indianhead. Also checked into the issue of Class II to the 9th Inf. G-1 was queried on the status of ROK's in regard to the cutback to a max of 25%.	
251		0900			Capt Stokes reported to C/S fr 9th Inf requesting a CIC team.	
252	24	0830		Oct	C/S conferred with G-1 and G-4 and AG directing that all equipment be closed into this area with special attention given to hand equipment.	Completed.
253		1040			C/S directed IG to make routine inspection of Div APO.	Completed.

C/S Daily Log
Item

No	Date	Time	In	Out	Action & Remarks
254	24	1500		Oct.	IG reported to the C/S that 8th Army postal inspector was at APO and he would help him in any way possible and would hold up on his own inspection at this time.
255	25	0900		Oct.	C/S directed that the IG forward to the CO 38th Inf the complaint of funds shortage in money order purchase for investigation. Completed.
256		0920			C/S directed SSO to investigate thru Army the reason for price differences in PX items. Completed.
257		1025			C/S conferred with G-4 in regard of the 25Trks Corps has taken fr the Div, C/S directed G-4 to take action to obtain their return.
258		1345			C/S left area to accompany CG to Inchon to inspect facilities there at, returning 1630.
259		2000			C/S conferred with G-5 and approved draft of Div Memo on Civil Affairs.
260	26	0940		Oct.	Chem Off reported to C/S results of his visit to Army Chemical Section yesterday. An investigation is in the process on the poisoning of water and food supplies by the red Army.
261		1025			C/S called Civil Affairs Off at EUSAK directing Ivanhoe 5 to proceed to Pyongyang by 1200 if possible.
262		1440			C/S met with Hq Comdt, Sig Off, and G-4 directing that the CP would move to Pyongyang 23 Oct 50.
263		1650			C/S called G-4 to verify that Army has agreed that 9th and 197th Abn would be supplied by air at their present location.
264	27	1040		Oct.	C/S conferred with G-1, AG, and PIO in regards to publishing of a booklet on the Div history and directed that investigation be made as to the possibility of having it published locally. Can be published in Japan.
265	28	0430		Oct.	C/S with sect on departed Vic of Seoul for new Div CP location at Pyon yang, arrivin there 281420.
266	29	0830		Oct.	C/S directed Hq Comdt and all sections that today would be clean up day for the CP so they can get it in shape for operation. Completed.

C/S Daily Log
Item

In	Date	Time	Action & Remarks
	In	Out	
267	2909	40 Oct.	C/S departed CP area to visit EUSAK Adv and 187th Abn areas, returning to CP area 291130.
268	3009	20 Oct.	C/S conferred with G-3 and CO 9th RCT on Civil Affairs within this zone. Recommendations that Army take control of this city will be taken to EUSAK.
269	1055		C/S conferred with PIO and Reporter (Dick Jones of the New York Times) in regard to attaching a commercial RCA unit to the Div for phone calls to the states. The commercial unit will be depended on the Div logistically and local protection. G-1 to clear above thru Army G-1.
270	1140		C/S called Index 6 informing him that control of PWE is under the 187th Abn at the present time, but that the 9th did have control of the entire city of Pyongyang.
271	1300		C/S discussed with G-3 and PM on the PWE's. Maj Becker (Div PM) stated that Maj Sullivan of Army has completed responsibility and if he has any trouble to call on Div PM. Maj Becker says that Maj Sullivan has a bunch of ROK's for his help and that Div will help him on rations, water, sanitation, etc.
272	1315		G-4 informs C/S that the 30 Trks will be at the 9th RCT at 1330 to move on Bn to Chinnampo.
273	1320		C/S informs PM that Army should have control of the PWE's and to call on the PM for any assistance Army may need. PM states he is all coordinated with 187th Abn on that.
274	1445		C/S confers with Maj Becker, Div PM, and Maj Sullivan, 8th Army PM Section, about the PWE's. Maj Sullivan says he is responsible to see that the PWE's are set up and operable, but needs assistance from the Div.
275	1650		G-1 informs C/S that Maj Strom went to Seoul to check on Class VI. C/S asks Capt Hoffman whether or not an L-17 could land at Haeju. Captain Hoffman says it will.
276	1745		C/S directed Hq Comdt to put out some identification to Koreans working within this Hq. Also personnel having Korean children will be directed to work with the Chaplain and place these children in a home. None to be allowed around this Hq. Completed.

C/S Daily Log
Item

No	Date	Time	In	Out	Action & Remarks
277	301800	Oct.			C/S informs Div Surg that we are responsible for the PWE's. Maj Becker is advisor and inspector. Div Surg to inspect them and lend every bit of assistance they can. Div Surg says that the Med Bn is being worked everywhere else and all they have here is the Hq. Maj Becker says he needs three trks to transport water and Med supplies for the PWE's. C/S informs PM that it is the units responsibility to get transportation.
278	2010				Ass't G-1 called C/S to report that there are EUSAK MP's at Tech advisors for the PWE's. Also that Maj Russel is the Staff PW Off fr Army and is generally around the PWE's.
279	310910	Oct.			G-3 reported to C/S before departing for the 23rd. He was directed to see that the trps were rotated on guard posts and outposts with those who were more comfortably suited and insure that the riflemen did not get all the details. Completed.
280	0950				C/S directed G-4 to procure some flags fr local market. Available at Seoul.
281	1010				C/S directed that G-1 have certificate made up for presentation to ROK trps as they leave the Div. Completed.
282	1020				C/S departed CP area for inspection of 187th Abn and 9th RCT, in turn, returning to the CP at 1205.
283	1320				C/S departed CP area for inspection of 9th RCT area, returning to CP at 1540.
284	2015				C/S instructs G-3 to call G-3 Army to find out whether or not the plan was firm, to tell him we are going ahead on its implementation. Ask him if the 9th is detached, does the 2d Div remain under EUSAK control and 9th under Div. Outline of present plan is - 1st Bn 9th present location at Sunan motorize tonight and move at 010700 Nov from Sunan to Tokchan to establish road blocks. Estimate the road blocks will be established by 1700, 1 Nov. See item 285
285	2045				G-3 under direction of C/S, called Army G-3. Army 3 informs G-3 that Ivanov will revert to Tempest when they move up in this area on or about 5 Nov. At present 9th RCT remains under Div control and Div remains under EUSAK. After reverting to Tempest, no doubt will continue present mission.
286	2055				C/S informs CG of the above info.

C/S Daily Log
Item

No	Date	Time	Action & Remarks
287	31 Oct.	In 2110 Out 2110	C/S calls Index 6 informing him that his trip to Corps is not necessary. CG informs Index 6 that either he or 106 will make the trip.
288		2120	C/S informs ADC of the info from Army and also of the trip by him or CG to Corps in AM.

G-1

HEADQUARTERS
2d Infantry Division
APO 248 c/o Postmaster
San Francisco, California

10 October 1950

SUBJECT: Activities Report for the Month of September 1950

TO: Commanding General
2d Infantry Division
ATTN: Div Historical Officer

I Narrative

The 1st day of September found the 2d Infantry Division in a critical tactical situation and as a result therefrom, the Administrative Personnel Procedures involving strengths and casualty reporting were temporarily confused insofar as accuracy was concerned. At 2200 hours 31 August, elements of three enemy divisions launched a general offensive all along the 2d Division front crossing the Nakdong River at several points and overrunning or bypassing the 1st and 2d Battalions of the 9th Infantry and the 1st Battalion of the 23d Infantry. By noon 1 September the situation was critical with 4 of the 7 infantry battalions on the line disorganized and suffering heavy losses. A gap of some six miles existing between the Changnyong-Yongsan area, split the Division zone into two parts, rendering communication and supply difficult. No accurate reports were available at the time, however it was estimated that the 1st and 2d Battalions of the 9th Infantry and 2d Battalion of the 23d Infantry had lost 50% of their combat effectiveness, while the 1st Battalion of the 23d Infantry was completely surrounded but fighting.

From 2d September to 9th September the Division was actively engaged in regaining by counter-offensive action, the ground lost during the enemy breakthrough. The 1st Provisional Marine Brigade was attached to the 2d Infantry Division on 3 September and assisted in restoring the situation. On 5 September the Marine Brigade was withdrawn from the line and attachment to the 2d Division. On the same date, the 2d Battalion, 23d Infantry, which had been attached to the 1st Cavalry Division was released from attachment and returned to the 2d Division to occupy that portion of the line previously established and held by the Marines. During the week following the 31 August enemy offensive, the 1st and 2d Battalions of the 23d Infantry, who initially lost an estimated 50% of their effective personnel, regained considerable effectiveness through the return of stragglers, isolated groups, and the attachment of 890 ROK soldiers received through replacement channels. Further strength was effected

by the transfer of men from the Division rear elements to bolster the rifleman strength of the 23d Infantry Regiment. This levy was made as follows: 20 EM from Division Headquarters, 24 EM from the 2d QM Company, 25 EM from the 702d Ordnance Company and 4 company grade officers from Division Headquarters. 500 additional ROK soldiers were also received and attached proportionately to the three infantry regiments.

On 16 September the Division launched an offensive to reach the Nakdong and to establish a bridgehead on the other side in conjunction with the all-out drive launched by the entire Eighth Army. For the rest of the month of September the 2d Division enjoyed tactical success in its drive west of the Nakdong. Spearheaded by the 38th Infantry Regiment, the leading elements of the Division advanced approximately 165 miles during the last 7 days of the month and were situated in the Nonsan area. There the Division was extended from the Nakdong River area to the Nonsan area, making it difficult insofar as supply and personnel administration was concerned.

During the month of September the losses of the Division exceeded the gains in personnel. Total losses, including MIA, amounted to 4341 while total gains through replacements, returnees to duty and returnees from MIA amounted to 2052. This latter figure includes only 604 actual replacements while the remainder were primarily returned wounded, sick, and MIA. The above figures concern American personnel only. To complete the strength gains and losses picture of the Division during the month of September, the ROK personnel attached to the Division and assigned proportionately through the units totaled 3940. Of this figure 3057 were present for duty at the end of September, the difference of 883 reflecting losses through casualties and non-battle casualties. The larger percentage of this figure of 883 includes approximately 500 missing ROK soldiers who have never returned nor wounded by the enemy. At the close of September all commanders had expressed their reluctance to accept any more ROK soldiers into the ranks of their units and some of the commanders expressed a desire to be relieved of the ROK soldiers then present within their commands. This attitude was primarily based upon the difficulties encountered due to the language barrier and the poor state of training of the individual ROK soldier as well as the ROK officers attached.

During the month of September the military discipline of the 2d Division remained good. All military offenders were being handled at the lowest echelon of command. Only two serious crimes were reported, one alleged armed robbery and one suspected murder, involving personnel of the Division. No evidence to warrant trial had been gathered in either case at the end of the month. A serious straggler problem existed in the division zone during the first three days of September, due to the breakthrough of the enemy forces on the Nakdong River front. Actual numbers of stragglers cannot be estimated inasmuch as some units

were completely surrounded and others were routed, many individuals and groups of individuals joining units other than their own. By the 4th of September the straggler situation had been corrected and during the remaining days of September stragglers were non-existent.

During the period of this month there were 1305 prisoners of war processed through Division FW channels. The breakdown of prisoners captured by units is reflected in the personnel Periodic Reports attached hereto.

Morale of the 2d Division has been exceptionally high throughout the month, with the exception of the first four days. Since the 5th of the month the troops have been on a continual offensive and the repeated successes in the drive toward the west has materially contributed to this high state of morale. Mail service has been constantly maintained wherever possible during the month. Some delay has been experienced in delivery of mail due to the fast movement of the division which extended the supply lines at certain periods. The Division EX officer has maintained a supply stock of items, not available through the gratuitous issue, which enables the men of the line units to procure much needed items such as toilet articles, snack items, etc. During the month of September, the Commanding General of the 2d Division has presented sixty one (61) Silver Stars, one hundred thirty four (134) Bronze Stars, eighty two (82) Air Medals, and seven (7) Distinguished Flying Crosses to personnel of the Division. In addition one (1) recommended Congressional Medal of Honor and one (1) recommended Distinguished Service Cross have been submitted to higher headquarters.

Civil Affairs activities during the month of September have been handled entirely by South Korean civilians and police authorities.

II Problems Encountered

During the early part of the month the principle problem encountered from an administrative standpoint was the control and evacuation from battle areas of thousands of Korean civilian refugees. In addition to being a refugee problem the situation presented a security threat to our forces in that the enemy infiltrated among the refugees to reach our rear areas. During the latter part of the month the principle administrative problem involved maintaining communication with and maintaining continuity of the administrative work of the Division Rear. The fast advances of the Divisional units combined with the non-availability of transportation to move the AG Rear presented many problems which under normal movements would not have existed.

II Problems Encountered (Contd)

Throughout the month, the most serious problem confronting the G-1 Section was the critical shortage of U. S. loss replacements, especially basic infantry riflemen. Having arrived in Korea at full T/O strength, the 2d Infantry Division was naturally placed in the lowest priority for replacements, but by 10 September its percentage effective strength was below that of other Divisions due to the heavy losses incurred in the defense of the Naktong line. One infantry battalion (1st Battalion, 9th Infantry,) had only 328 officers and men on 2 September, 560 short of T/O. In spite of emergency requisitions, very few replacements were received and the Division was, and continues to be, some 3500 EMI short.

III Solutions to Problems Encountered

The early refugee problem was solved by establishing refugee screening points and routes of evacuation to predesignated areas where the groups were maintained under surveillance. The Division Provost Marshal, MP Company, and attached CIC, with the added help of South Korean CIC and Police, coordinated and furnished the necessary personnel to control the processing and evacuation.

The solution to the problem of attempting to maintain the Division AG and Rear echelon within reasonable distance of the forward elements is primarily a matter of transportation. By the use of organic transportation when available or by requesting transportation from higher headquarters is the only solution for the problem.

No satisfactory solution has been arrived at concerning the problem of obtaining loss replacements. ROK soldiers were not satisfactory and it remains for higher headquarters to provide US replacements.

6 Incls:

1. G-1 Periodic Report # 3
2. G-1 Periodic Report # 4
3. G-1 Periodic Report # 5
4. G-1 Periodic Report # 6
5. G-1 Journal (Month of Sept)
6. Report of ROK Personnel

JAMES D. TANNER
Lt Col GSC
AC of S G-1

SECRET

In 2d Inf Div
APO 242 a/o Ft SF, Calif
091800 Sept 60

Personnel Periodic Report # 2
2 Sept 60 to 9 Sept 60

SECRET

Charts and Maps: Maps: KOREA, 1:50,000

1. OPERATIONS

a. General - From 2 Sept to 9 Sept the 2d Infantry Division (-) engaged in fighting and holding ground lost during the enemy breakthrough of 31 Aug - 1 Sept 60. New defensive position on line approximately 2 miles W of CHANGHONG-PUKKONAN NEN has been established and is now being held against intermittent enemy attacks. Remaining personnel of isolated groups of the Division were retrieved during this period. The 1st Provisional Marine Brigade was attached to the Division on 3 September 60 and aided the Division to reestablish line now held. The Marine unit was withdrawn from the line and from attachment to the 2d Division on 5 September 60. On the same date the 2d Bn 23d Infantry was released from attachment to the 1st Cavalry Division and returned to the 2d Division sans to occupy the line established and held by the 1st Provisional Marine Brigade. The 2d Bn 6 Bn was put into the line during this period and an infantry troops is now occupying the left sector of the Division's present defense line. Immediately after the enemy breakthrough of 31 Aug - 1 Sept elements of the Division rear echelon were organized and employed to man certain critical terrain features in the rear of the Division sans and to become a potential reserve if necessary. The 1st and 2d Bns of the 9th Infantry and the 2d Bn of the 23d Infantry who initially lost 80% of their effectiveness during the aftermath of the enemy breakthrough have regained considerable effectiveness through the return of isolated groups, stragglers and the attachment of ROE soldiers received through replacement channels.

b. Losses during this period exceeded 25 replacements. Losses totaled some 1730 including MIA and non-battle while only 550 officers and enlisted personnel were received from replacement channels and as hospital returnees. In addition, 190 men returned from MIA to become effectives.

c. 800 ROEs received during this period and were assigned as follows:

2d Bn 6 Bn - - - 100
23d Inf - - - - 570
9th Inf - - - - 200
2d Bn 6 Bn - - - 28
2d Recon Co - - - 78
Div Hq (Def Ptb) 28

This makes a total of 1000 ROEs received to date in the 2d Infantry Division.

Encl #1

SECRET

SECRET

d. For breakdown of strength and losses within the Division, see attached chart.

2. REPLACEMENTS

SECRET

Requisition for replacements to bring the Division to full T/O strength was submitted as of 7 Sept 50 in compliance with Cir 31, EUSAK dated 6 Sept 50. Replacements received during period of this report, see per 1b.

3. DISCIPLINE, LAW AND ORDER

a. Military discipline - good

b. Military justice - offenders are being dealt with, when possible, at the lowest authorized echelon of command. One serious crime involving personnel of the 58th Infantry Regiment has been reported. This case (suspected murder) has been turned over to the USAF CID for investigation.

c. Stragglers - Stragglers apprehended by Military Police at traffic control points and stragglers control and collecting points are returned to their organizations by the first available transportation. During this period only 15 stragglers reached as far to the rear as MIRYANG.

4. PRISONERS OF WAR

a.	9th Infantry	- - -	9
	23d Infantry	- - -	70
	38th Infantry	- - -	5
	72d Tk Bn	- - -	1
	Marine Brigade	- - -	9
	2d Recon Co	- - -	1
	2d CIC	- - - - -	3
	2d MP Co	- - - - -	1
	58 CIC	- - - - -	6
	ROK	- - - - -	1
	Unk	- - - - -	32

TOTAL 186

b. As of the end of this report period there were 35 POW's being held in the Division PWs at MIRYANG.

5. BURIALS AND GRAVES REGISTRATION

a. A total of 277 internment of which 248 were identified and 29 unidentified, were made in the 2d Infantry Division cemetery at MIRYANG. Grave numbers 469 to 769 were utilized with the exception of graves numbered 551, 625, 645 - 653, 666, 667 and 670. Identified burials included 139 from the 2d Infantry Division and 44 from other units. The

SECRET

SECRET

remaining known dead are pending identification of organizations. Identified ROE burials total 16.

b. Many dead located within the Division zone are buried locally with the use of indigenous labor and in areas designated by local GI teams.

6. MORALE AND PERSONNEL SERVICE.

a. Morale remains good despite the percentage of personnel loss. The most serious threat to morale during the period of this report was the three day period of continuous rain.

b. Personnel Services - tobacco, cigarettes and reading and writing material is plentiful in all units. PX supplies are readily available.

c. A temporary delay in processing recommendations for awards and decorations was incurred during this period due to the utilization of all clerks and administrative personnel to supplement existing forces and provide security for critical installations. 16 recommendations for decorations are being processed at the close of the report period and will be ready for presentation within 24 hours.

7. CIVIL AFFAIRS

The refugee situation is a continuous effort on the part of C-2, CSC, and the Provost Marshal. During this period approximately 20,000 refugees have been screened and removed from the DMZ area to SREAN-01.

8. REGULATIONS

Administrative directives are published periodically. No change has occurred in procedures.

9. DEFENSE INSTALLMENTS

Shelter throughout the Division zone is adequate, consisting of organizational tents primarily. Recreational structures are being utilized in some instances.

10. CIVILIAN EMPLOYEES

a. 9th Infantry - - - 16
Division Engineer - - 50
Division Forward - 32
2d Medical Bn - - 50
VOCB Ordnance - - 53
Division Artillery 11
2d AF - - - - - 8
7th AF Bn - - - - 1

TOTAL 136

SECRET

SECRET

b. Groups of civilian laborers are being recruited and used on a one-job basis when required by units.

SECRET

2. 2015:

1. Strength Chart
2. Station List

SECRET, TANGOR
LA 201 000
AO of 2 0-1

SECRET

SECRET

UNIT	STRENGTH		GAIN				LOSSES			BCK		
	Assigned		Enpl	Retar	Other	TOTAL	non		Enpl & Ret	ASGD	ACTUAL	
	OPF	EN					Battle	Battle				TOTAL
Div 1st Cav	24	77	223	1	1	0	2	1	1	2		
Div 1st Cav	24	126	1	0	0	1	0	2	2			
Inf Co	16	172	190	12	0	0	12	0	0	0	25	25
Div 1st Cav Det	2	15	14	0	1	0	1	0	1	1		
Div Army	234	2270	2696	7	10	0	17	53	37	95	49	49
9th Inf	120	2322	2703	37	88	1	126	196	64	252	945	955
23 Inf	120	2024	2729	7	87	0	94	520	70	660	375	374
30th Inf	150	2293	2733	11	51	0	62	447	104	561		
2d Reg Bn	45	200	341	2	2	0	4	0	0	0		
702d Reg	20	227	321	0	1	0	1	0	5	5		
2d CML Co	12	244	252	0	0	0	0	2	5	5		
2d Sig Co	16	340	309	1	1	0	2	3	3	6	25	25
72d Tk Bn	41	506	651	0	14	0	14	35	20	55		
2d MP Co	7	173	187	1	3	0	4	6	2	8	46	40
2d Repl Co	7	23	42	0	0	0	0	0	0	0		
Band	2	25	70	0	0	0	0	0	0	0		
2d Regt	45	614	977	0	10	0	10	46	11	57	100	100
2d Rem Co	6	134	171	0	0	0	0	15	3	13	75	75
Total Div	600	14,573	16,214	60	209	1	250	1408	324	1730	1030	1222
CIC	8	9	7	0	0	0	0	0	0	0		
528 MI Flt	1	12	30	0	0	0	0	0	0	0		
ACC TOTAL	697	14,599	16,241	60	209	1	250	1408	324	1730	1030	1222

Enpl of 1

SECRET

SECRET

Hq 2d Inf Div
APO 243 c/o PW, SF, Calif
161600 Sept 50

Personnel Periodic Report No 4
9 Sept 50 to 16 Sept 1950

Charts and Maps: Maps: KOREA, 1:50,000

1. STRENGTHS

a. During this report period the Division (-) continued to regain ground lost during the enemy breakthrough of the HAKTONG line of 31 Aug - 1 Sept 50. Further transfers of men from the Division rear elements were made to bolster the rifleman strength of the 23d Infantry Regiment. This levy was made as follows: 20 EM from Div Hq, 24 EM from 2d QM Co, 25 EM from 702d Ord Co, and 4 Co grade officers from Div Hq. In addition ROK personnel, as shown in subparagraph c below, were received during this period and attached to the units of the Division. On 14-25 Sept an adjustment of the lines was made to regroup all units within the zone of their parent unit, prior to an all-out offensive to regain the HAKTONG River line. The 2d Engr C Bn was withdrawn from the left sector on 15 Sept to revert to its primary engineering mission and to constitute a Division reserve on call. The 2d Recon Co was moved into the sector vacated by the 2d Engr Bn. On the morning of 16 Sept the Division attacked with the mission of destroying the enemy in its zone and securing crossings on the HAKTONG River. At the close of this report period, elements of the 23d and 38th Infantry had reached the river. The attack was made with comparatively few casualties, except in the 9th Infantry which encountered the enemy heavily entrenched on hill 201.

b. Losses during this period exceeded US replacements. Losses totaled some 787 including MIA and non-battle while only 564 replacements were received through replacement channels and hospital returnees. In addition 79 men returned from MIA to become effectives.

c. 500 ROKs received during this period and were assigned as follows:

9th Infantry	150
23d Infantry	150
38th Infantry	200

This makes a total of 2140 ROKs received to date in the 2d Infantry Division.

d. For breakdown of strength and losses within the Division see attached chart.

2. REPLACEMENTS

Requisitions for personnel replacements have been submitted in accordance with Cif 31, Hq EUSAK, dated 5 Sept 50. Number of replacements

Incl #2

SECRET

SECRET

b. Personnel Services - Tobacco, cigarettes, and writing material is plentiful in all units, PX supplies are readily available. The Division PX, operating in the rear echelon, sold \$10,000.00 worth of merchandise since its inception, with stock supplied by the Eighth Army PX.

SECRET

c. Postal services. The Division APO did a heavy money-order business during the period, selling between \$18,000.00 and \$20,000.00 worth of orders and stamps daily, stamps being a negligible factor.

d. Awards and Decorations - During this period the following recommendations for decorations were procured by the A & D Board and forwarded to higher headquarters:

One (1) recommended CMH
Two (2) recommended DSC

Fifteen (15) Silver Stars and thirty-five (35) Bronze Stars were awarded to individuals of the Division. Presently pending action by the A & D Board are recommendations for one (1) CMH, eight (8) Silver Stars, nineteen (19) Bronze Stars, and five (5) Air Medals.

7. CIVIL AFFAIRS

The refugee situation is a continuous effort on the part of the G-2, CIC, and MI, however, it is also an ever decreasing problem. At the close of this period there are approximately 7 to 8,000 refugees camped near YONGSAN, and approximately 2500 have been reported near CHANG-DO.

8. PROCEDURES

Administrative directives are published periodically. No change has occurred in procedures.

9. INTERIOR MANAGEMENT

Shelter through the Division zone is adequate, consisting of organizational tents primarily. Structures are being used in some instances.

10. CIVILIAN EMPLOYEES

a. 9th Infantry	15
b. 23d Infantry	15
c. 38th Infantry	15
d. Division Rear	50
e. Division Forward	52
f. 2d Med Bn	36
g. 702d Ord Co	53
h. Div Arty	11
i. 2d Sig Co	5
j. 72d Ev Tr Bn	17
TOTAL	268

2 Incls
1 Strength Chart
2 Station List

SECRET

JAMES D. TANNER
Lt Col. GSC
AC of S. C-1

SECRET

received during this report period see para 1b.

3. DISCIPLINE, LAW AND ORDER SECRET

a. Military discipline: Good

b. Military offenders: Military offenders are being handled at the lowest echelon of command when appropriate. One (1) serious crime has been reported during this report period involving personnel of the 72d Heavy Tk Bn. This case, reported as armed robbery, is presently under investigation.

c. Stragglers: Stragglers are returned to their units immediately upon apprehension at Military Police straggler control and collecting points. During this period only 13 stragglers filtered past the Division straggler line and reached MIRYANG. All have been returned to their units.

4. PRISONERS OF WAR

a. The following prisoners of war were captured and evacuated through PW channels during this period:

9th Infantry	- - - 9
23d Infantry	- - 21
30th Infantry	- - 5
2d MP Company	- - 1
SK Police	- - - 4
RCK	- - - - 2
Unknown	- - - - 14

TOTAL 56

5. BURIALS AND GRAVE REGISTRATION

A total of 162 interments of which 137 were identified and 15 unidentified were made in the 2d Infantry Division cemetery at MIRYANG. Grave numbers 745 - 902 inclusive, plus numbers 625, 669, 669, and 670 were utilized. Grave numbers 757 - 726 were not utilized. Identified burials included 64 of the 2d Division, 7 of other US Army Organizations. 52 burials were identified by name but determination of organization is pending. 14 Korean ROK soldiers were buried during this period and are included in total figure above.

6. MORALE AND PERSONNEL SERVICES

a. A definite raise in morale has been experienced during this period. This is attributed to the current offensive actions of the Division. The only threat to morale during this period was the cessation of mail deliveries during the 4 day period 12 - 15 Sept 50. Reason for the mail stoppage was beyond the control of the Division and stemmed from the non-receipt of mail from the Pusan Base PO. Resumption of mail deliveries on 18 September 50 indicates this problem has been solved.

SECRET

SECRET

SECRET

UNIT	STRENGTH			GAINS				LOSSES			ROK		
	Assigned			Repl	Retur nees	Other	TOTAL	Battle	non battle	TOTAL	Repl & Rets	Asgd	Actual
	Off	EM	Auth Agr										
Div Hq Fwd	43	75	253	0	0	0	0	0	1	1			
Div Hq Rr	35	124		2	0	0	2	0	1	1			
Hq Co	15	156	189	2	0	0	2	0	1	1		25	25
Div Med Det	2	15	14	0	0	0	0	0	0	0			
Div Arty	254	3233	5695	6	15	0	20	38	32	60	1	51	49
9th Inf	129	557	5793	85	134	0	219	73	110	183	10	945	595
23 Inf	138	2538	3793	86	77	0	163	193	84	277	310	695	652
38th Inf	130	2789	3793	36	60	0	96	158	100	258	204	204	203
2d Med Bn	45	282	341	8	0	0	8	0	3	3			
702 Ord	20	272	321	2	0	0	2	0	2	2			
2d QM Co	15	216	252	1	1	0	2	3	3	6			
2d Sig Co	17	350	369	0	1	0	1	0	3	3		25	25
72 Tk Bn	40	572	684	6	8	0	14	14	24	38			
2 d MP Co	7	174	187	3	2	0	5	0	4	4	1	46	41
2d Repl Co	7	34	41	1	0	0	1	0	0	0			
Band	2	93	70	0	0	0	0	0	1	1			
2d Engr Co	39	774	977	3	18	0	21	12	54	66	2	102	101
2d Recon Co	6	140	171	0	8	0	8	0	3	3	1	76	75
TOTAL DIV	920	14180	18914	241	323	0	564	461	326	787			
CIC	8	9	17	0	0	0	0	0	0	0	0	0	0
SES MI Flt	1	7	30	0	0	0	0	0	0	0	0	0	0
AGG TOTAL	929	14196	18961	241	323	0	564	461	326	787	589	2169	1767

Incl # 1

SECRET

SECRET

Hq 2d Inf Div
APO 246, c/o PLS, SF, Calif

STATION LIST

MAP: KOREA, 1:50,000

SECRET

UNIT	LOCATION
9TH INFANTRY REGIMENT (-)	1143.9 - 1388.0 1308.8 - 1388.8
23D INFANTRY REGIMENT	1140.8 - 1395.9 1307.2 - 1307.2
38TH INFANTRY REGIMENT	1130.8 - 1400.4 1308.5 - 1400.0
DIVISION ARTILLERY HEADQUARTERS	1151.1 - 1402.7 1308.2 - 1408.8
16TH FIELD ARTILLERY BATTALION	1145.5 - 1388.5 1304.9 - 1388.1
57TH " " "	1142.0 - 1398.3 1307.3 - 1408.8
38TH FIELD ARTILLERY BATTALION	1132.7 - 1400.9 1306.2 - 1408.4
503D " " "	1143.5 - 1397.4 1306.0 - 1388.1
32D AAA BATTALION	1143.5 - 1397.4 1308.7 - 1408.7
DIVISION HEADQUARTERS REAR	1174.0 - 1392.0 (MIRYANG) Same
DIVISION HEADQUARTERS FORWARD	1149.8 - 1396.2 1304.8 - 1388.8
HEADQUARTERS COMPANY, 2D DIVISION	1144.7 - 1396.2 1304.8 - 1388.8
MEDICAL DETACHMENT, 2D DIVISION	" " " 1304.8 - 1388.8
2D MEDICAL BATTALION	1174.8 - 1398.2 Same
2D QUARTERMASTER COMPANY	MIRYANG RAILHEAD
2D RECON COMPANY	1151.1 - 1386.3 1307.3 - 1388.2
2D MILITARY POLICE COMPANY	1149.8 - 1396.2 1304.8 - 1388.8
2D SIGNAL COMPANY	1149.5 - 1396.2 1304.8 - 1388.8
702D ORDNANCE COMPANY	1146.5 - 1398.5 NAH-NH (1304 - 1389)
72D TANK BATTALION	1147.1 - 1403.1 1307.2 - 1394.6 1152.0 - 1387.0
2D ENGINEER C BATTALION	1149.1 - 1398.5 1304.8 - 1388.8

Incl # 2

SECRET

SECRET

Hq 2d Inf Div
APO 248 o/o FM, SF, Calif
251800 Sept 60

Personnel Periodic Report No. 5
16 Sept 60 to 23 Sept 60

SECRET

Charts and Maps: KOREA, 1:50,000

1. STRENGTH

a. During this report period the 2d Infantry Division (-) continued its advance crossing the HAEUNG river and established a firm beachhead west of the river. Leading elements of the 38th Infantry reached CHUNGYE (1125.7-1400.8) 22 Sept 60. The 9th Infantry Regiment was stopped in its attempt to cross the HAEUNG in the southern sector of the Division zone. At the close of this report period the 23d and 38th Regiments had progressed several miles west of the river and the 9th Regiment was consolidating to move across the river.

b. Losses during the period exceeded US replacements. Losses totaled 1304 including MIA and non-battle while only 366 replacements were received through replacement channels and hospital returnees. In addition 5 men returned from MIA to become effectives.

c. 1000 ROKS were received during this period and were assigned as follows:

Division Artillery	350
38th Inf Regiment	350
23d Inf Regiment	200
38th Inf Regiment	2.0

In addition 20 ROK liaison officers were received and assigned proportionately to units with ROK troops, making a total of 3100 ROKS received to date in the 2d Infantry Division.

d. For breakdown of strength, gains and losses within the Division see attached chart.

e. During the period, 3 Lt Cols were promoted to Full Col. and 4 Majors were promoted to Lt Col.

f. The 628th MI Btl, furnished to the Division prior to departure from Ft Lewis was transferred to I Corps.

2. REPLACEMENTS

a. Requisitions for personnel replacements have been submitted in accordance with Air 31, Hq USMACV, dated 5 Sept 60. Number of replace-

encl #3

SECRET

ments received during period is reflected in attached chart. Infantry riflemen continue to be in critical short supply. The Division Artillery needs Company Grade Officers for forward Observers.

b. There are increasing reports that the BERS are unenthusiastic as combat soldiers. They are unwilling to fight and the infantry regiments indicate that they would rather not have them at all, in spite of a grave shortage of riflemen.

3. DISCIPLINE, LAW AND ORDER

a. Military discipline: Good

b. Military offenders: Military offenders are being handled at the lowest echelon of command when appropriate. No serious crime involving personnel of the 2d Infantry Division has been reported during this period.

c. Stragglers: Stragglers are returned to their units immediately upon apprehension. In view of the change from a defensive to an offensive situation, the stragglers have decreased to a point where their numbers are negligible.

4. PRISONERS OF WAR

9th Infantry Regiment	6
23d Infantry Regiment	51
30th Infantry Regiment	172
30th Fld Arty Battalion	4
2d Div Security Force	6
NA CIC	2
Unknown	<u>23</u>

TOTAL 309

5. BURIALS AND GRAVES REGISTRATION

A total of 205 interments of which 171 were identified were made in the 2d Infantry Division cemetery at HIRYANG. Grave numbers 303 to 1105 were utilized. All of the identified burials were members of the 2nd Infantry Division, including attached NCK troops.

6. LOCAL AND PERSONNEL SERVICE

a. Excellent morale is enjoyed by all Divisional units. There has been no serious threat to the morale during this report period.

b. Personnel services - The Division operated its own PX during this report period but at the close of this period it was directed to discontinue this service because of the gratuitous issue of cigarettes and some sundry items. However, this issue does not include items which

SECRET

SECRET

the combat units are requesting, (stationery, razor blades, soap, towels, tooth brushes, good candy, cigars, peanuts, crackers, etc,) which the Division FX was in a position to supply through bulk sales at the Rear Echelon and by a mobile FX truck, just obtained. This has a most adverse effect on morale and the Commanding General has indicated that he definitely desires to operate a FX in order that the fighting troops can obtain items which rear-area troops get, notwithstanding free cigarettes and inferior candies.

c. Postal services - All services are available and adequate. Postal service installations are moved forward in order to more adequately serve the troops needs. The Division APO operates a forward branch at the DQ: Class I Supply Point.

d. Awards and Decorations - During this period the following recommendations were processed by the A & D Board: One (1) recommended Congressional Medal of Honor, eight (8) Silver Stars, nineteen (19) Bronze Stars and five (5) Air Medals. Presently pending action by the board are: One (1) Distinguished Service Cross, thirty-eight (38) Silver Stars, Eighty (80) Bronze Stars, seven (7) Distinguished Flying Crosses, and seventy-seven (77) Air Medals.

7. CIVIL AFFAIRS

The refugee problem, now that the Division is on the offensive, has ceased to be of any great significance. Refugees encountered kept off all roads and the 2nd CIC Det screens any groups encountered.

8. PROCEDURES

Administrative directives are published periodically. No change has occurred in procedures.

9. INTERIOR MANAGEMENT

Shelter throughout the Division zone is adequate, consisting primarily of organizational tents etc. Structures are being used in some instances.

10. CIVILIAN EMPLOYEES

9th Infantry Regiment	15
23d Infantry Regiment	15
38th Infantry Regiment	15
Division Rear	50
Division Forward	52
2d Medical Battalion	14
702d Ordnance Company	109
Division Artillery	23
2d Military Police Company	8
72d Heavy Tank Battalion	17

SECRET

SECRET

24 Quartermaster Company 10
TOTAL 328

SECRET

2 Incls:

1. Strength Chart
2. Station List

JAMES D. TANNER
Lt Col GOC
AC of S, G-1

SECRET

SECRET

Hq 2d Inf Div
APO 249, c/o Ft. SF, Calif

STATION LIST

MAP: KOREA, 1:50,000

SECRET

<u>UNIT</u>	<u>LOCATION</u>
02H INFANTRY REGIMENT (-)	1143.9 - 1388.0
23D INFANTRY REGIMENT	1140.8 - 1396.0
30TH INFANTRY REGIMENT	1130.8 - 1400.4
DIVISION ARTILLERY HEADQUARTERS	1161.1 - 1402.8
18TH FIELD ARTILLERY BATTALION	1145.5 - 1388.6
37TH " " "	1142.0 - 1393.3
38TH " " "	1132.7 - 1400.0
603D " " "	1143.5 - 1397.4
02D AAA BATTALION	1143.5 - 1397.4
DIVISION HEADQUARTERS REAR	1174.0 - 1392.0 (MINYANG)
DIVISION HEADQUARTERS FORWARD	1149.8 - 1396.2
HEADQUARTERS COMPANY, 2d INF DIV	1149.8 - 1396.2
MEDICAL DETACHMENT, 2D DIVISION	1149.8 - 1396.2
2D MEDICAL BATTALION	1174.8 - 1398.1
2D QUARTERMASTER COMPANY	MINYANG BARRACKS
2D SIGNAL COMPANY	1161.1 - 1388.3
2D MESSENGER BATTALION COMPANY	1143.0 - 1396.2
2D SIGNAL COMPANY	1149.8 - 1396.2
700D COMMUNICATIONS COMPANY	1143.8 - 1398.5
72D TANK BATTALION	1137.1 - 1403.1
2D ENGINEER COMPANY BATTALION	1149.1 1398.8

Incl # 2

SECRET

Hq 2d Inf Div
APO 243 c/o FM, SF, Calif
301300 Sept 50

Personnel Periodic Report No 6
23 Sept 50 to 30 Sept 50

SECRET

GRANTS AND MAPS: NONE, 1,250,000

1. OPERATIONS

a. During this report period the 2d Infantry Division continued its advance on the HYPONGH-KOCHANG-CHONGJU axis with only scattered resistance reported. At the close of the period elements of the 38th Infantry Regiment had secured KANGYONG and KORMAL. The 23d and 9th Infantry Regiments had secured the MSR from the HANTONG River crossing to CHONGJU with patrolling missions on all flanking routes and approaches. During the report period the 38th Infantry Regiment spearheaded the Division advance of approximately 125 miles. The 65th Regimental Combat Team was attached to the 2d Infantry Division with the mission assigned of securing the sector east of the HANTONG River.

b. Losses during this period exceeded US Replacements. Losses totaled some 440 including MIA and non-battle casualties while only 390 replacements were received through replacement channels and hospital returns. In addition 9 men returned from MIA to become effectives.

c. 390 ROEs were received during this period and were assigned as follows:

9th Infantry Regiment	25
38th Infantry Regiment	25
2d Medical Battalion	75
2d Signal Company	25
2d Quartermaster Company	25
702d Ordnance Company	50
72d Tank Battalion	75

d. For breakdown of strength, gains and losses within the Division see attached chart.

2. REPLACEMENTS

a. Requisitions for personnel replacements have been submitted in accordance with Ctr S1, Hq USMACV, dated 5 Sept 50. Number of replacements received is reflected in attached chart. Infantry riflemen continue to be the one critical shortage. Company grade Field Artillery officers as Forward observers is also a pressing requirement.

b. As of the close of this report this Division does not desire to integrate any additional ROE soldiers into the units. All commanders have expressed their reluctance toward accepting any additional ROE personnel.

Incl #4

3. DISCIPLINE, LAW AND ORDER

- a. Military discipline - good
- b. Military offenders - Military offenders are being handled at the lowest echelon of command when appropriate. No serious crime involving personnel of the 2d Infantry Division has been reported during this period.
- c. No straggler problem existed during this report period.

4. MEMBERS OF WAR

24th Infantry Regiment	4
25th Infantry Regiment	205
30th Infantry Regiment	407
2nd CIC	11
2nd MP Co	49
2nd SM Co	4
2nd Stry	25
37th PA Bn	26
2nd Recon Co	5
GRIP	2
SK CIC	1
2d Div Pcs	2
2d Div Security Force	1
22d AAA Bn	3
Unk	7
TOTAL	<u>642</u>

5. BURIALS AND GRAVES REGISTRATION

A total of 101 interments of which 91 were identified were made in the 2d Infantry Division Cemetery at HIRWANCS. This report is up to and including 23 Sept. The reports of 29-30 Sept were not received in time for inclusion in this week's report but will be included in the next periodic report. All of the identified burials were members of the 2d Infantry Division, including attached ROK troops.

6. MORALE AND PERSONNEL SERVICES

- a. Excellent morale is enjoyed in all Divisional units.
- b. Personnel services - PX supplies of all kinds are available to all troops. A Divisional PX supply is maintained in order that troops may purchase essentials or other items not available in the gratuitous issue. This is accomplished by bulk sales to units and not to individuals.
- c. Postal services - there has been some delay during this period in the mail deliveries due to the rapid forward movement of the units and the extended supply lines. This situation is expected to return to normal as soon as the Division Rear is moved to a more forward area.

d. Awards and Decorations - During this period the A D Board processed awards for one (1) DSC, thirty eight (38) Silver Stars, eighty (80) Bronze Stars, seven (7) DFC, and seventy seven (77) Air Medals.

7. CIVIL AFFAIRS

a. No refugee problem exists.

b. The Division JA is investigating reported cases of War atrocities within the Division one.

8. REGULATIONS

Administrative directives are published periodically. No change has occurred in procedures.

9. INTERIOR MANAGEMENT

Shelter throughout the Division zone is adequate, consisting primarily of organizational tents. Structures are being used in some instances.

10. CIVILIAN EMPLOYEES

9th Infantry Regiment	15
23d Infantry Regiment	15
36th Infantry Regiment	15
Division Rear	50
Division Forward	82
2d Medical Battalion	14
702d Ordnance Company	100
Division Artillery	23
2d Military Police Company	8
72d Heavy Tr Bn	17
2d QM Co	10

TOTAL 328

1 Incl

1. Strength Report

JAMES D. TAMER
Lt Col CUC
AC of S, G-1

SECRET

UNIT	STRENGTH			GAINS				LOSSES			RCK		
	Assigned			Repl	Retur ness	Other	TOTAL	BATTLE RET	NON BATTLE	TOTAL	Repl & Ret	ASGD	ACTUAL
	EFF	EM	AUTH AGG										
1st Bg Fwd	45	74		1			1						
1st Bg Br	30	122	223	1			1				1		
3 Co	15	185	190						1	1		27	27
1st Med Det	2	12	14										
1st Arty	223	3205	3095	12	11		13	15	10	25		612	609
1st Inf	125	2097	3793	124	94		218	61	43	124	33	1192	675
3d Inf	126	2240	3793	2	73		75	95	17	112		903	696
9th Inf	118	2419	3793	7	42		49	124	15	139	33	625	512
1st Med Bn	43	287	341	5	3		8				75	75	70
2nd Ord	21	267	321						3	3	50	50	50
1st QM Co	14	215	252									20	26
1st Sig Co	17	300	309	2			2		3	3	25	50	50
2d Tk Bn	30	554	661		4		4		2	2	73	70	70
1st MP Co	6	170	167	2			2	1	5	6		46	41
1st Repl Co	11	43	41										
band	2	93	702K										
1st Engr Co	37	737	977	2	3		5	10	2	21	100	200	103
1st Recon Co	5	123	171		3		3		4	4		77	63
TOTAL DIV	897	1316	14088	159	23	2	390	335	105	440	302	3040	3057
CIC	0		17	0	0		0						
65 Inf Div	0		0	0	0		0						
GO TOTAL	906	1316	14003	159	23	2	390	335	105	440	302	3040	3057

Incl 1

Hq 2d Inf Div
APO 248 o/o PM, SF, Calif.
30 Sept 50

STATION LIST

MAP: KOREA, 1:250,000

SECRET

<u>UNIT</u>	<u>LOCATION</u>
9TH INFANTRY REGIMENT	42053935
23D INFANTRY REGIMENT	53023965
38TH INFANTRY REGIMENT	32024004
DIVISION ARTILLERY	33023965
15TH FIELD ARTILLERY BATTALION	42053936
37TH FIELD ARTILLERY BATTALION	33023965
38TH FIELD ARTILLERY BATTALION	32024004
603D FIELD ARTILLERY BATTALION	33023965
82D AAA AV BATTALION	33023965
DIVISION HEADQUARTERS REAR	MIRYANG (47083928)
DIVISION HEADQUARTERS FORWARD	39023945
HEADQUARTERS COMPANY 2D INF DIV	39023945
MEDICAL DETACHMENT, 2D INFANTRY DIV	MIRYANG "
2D MEDICAL BATTALION	40033949
2D QUARTERMASTER COMPANY	33023965 33068965
2D RECON CO	
2D MILITARY POLICE COMPANY	39023945
2D SIGNAL COMPANY	39023945
702D ORDNANCE COMPANY	40033949
72D TANK BATTALION	32083993
2D ENGR "C" BATTALION	33023965

SECRET

G-1 JOURNAL

FROM: 00011 Sept 50

TO: 1159 2 Sept 50

CLASS: UNCLASSIFIED

TIME	No.	INCIDENTS, MESSAGES, ORDERS, ETC.	ACTION TAKEN
0900	1	G-1 called Lt. Rear and ordered 1 platoon to send for the and and 100 additional for combat. 500 soldiers into rear area. This formation to be sent on to the Division or 4th Division.	
1000	2	
1300	3	Provisional to the 2d and 1st	
1330	4	-1	
1440	5	
1645	6	
1730	7	
1800	8	
1845	9	-1	
2100	10	
0215	11	-1	
1030	12	-1	
1100	13	
1130	14	
		1200 2 to 240	
		1130 3 to 10	
1200	1	-1	
1300	2	-1	
1700	3	1st	
1800	4	

INCL # 5

G-1 JOURNAL

FROM: 1200 3 Oct 50

TO: 1155 4 Oct 50

PLACE: HMM-11, FORM

TIME	No.	Time	INCIDENTS, MESSAGES, ORDERS, ETC.	ACTION TAKEN
1200	1		Capt. Dennis' call to 10th and 8004 to report report.	
1240	2		Call to 10th and 8004 as staff	
1400	3		Call to 10th and 8004 to check status.	
1500	4		Call to 10th and 8004 re: 10th and 8004	
1745	5		Call to 10th and 8004 re: 10th and 8004	
0800	6		Call to 10th and 8004 re: 10th and 8004 (re: 10th and 8004)	
1200	7		Call to 10th and 8004 re: 10th and 8004 (re: 10th and 8004)	

1200 4 Oct 50

1155 4 Oct 50

PLACE: HMM-11, FORM

1300	1		Article to 10th and 8004 re: 10th and 8004	
1300	2		Article to 10th and 8004 re: 10th and 8004	
1400	3		Article to 10th and 8004 re: 10th and 8004 (re: 10th and 8004)	
1500	4		Article to 10th and 8004 re: 10th and 8004 (re: 10th and 8004)	
2000	5		Article to 10th and 8004 re: 10th and 8004 (re: 10th and 8004)	
2245	6		Article to 10th and 8004 re: 10th and 8004 (re: 10th and 8004)	
2300	7		Article to 10th and 8004 re: 10th and 8004 (re: 10th and 8004)	
1700			Article to 10th and 8004 re: 10th and 8004 (re: 10th and 8004)	

1200 5 Oct 50

1155 5 Oct 50

PLACE: HMM-11, FORM

1200	1		Call to 10th and 8004 re: 10th and 8004 (re: 10th and 8004)	
------	---	--	---	--

G-1 JOURNAL

CONTINUATION

FROM: 1200 5 Sept 50

TO: 1100 6 Sept 50

PLACE: UNMI-III, AREA

TIME	No.	Time	INCIDENTS, MESSAGES, COMMENTS, ETC.	ACTION TAKEN
IN	OUT			
1400	2		CG Air G-1 to obtain US more air for and take over control of UNMI-III air with one tank sector for 24 hours. Near 2nd notified. Base file (last G-1) alerted to take charge, 1800	
	3		CG Air G-1 to guard and establish road block (w/det of which he is in c.c.) on 1800	
1800	4		1800 hrs. to 1800 hrs. in.	
1800	5		CG Air G-1 to 2nd signal to	
1800	6		CG Air G-1 to 2nd signal to	
1100	7		Tactical sit: surveillance with enemy units reported. 1800 hrs. ordered to a 20 mile road along ridges 2-3 miles N of the UNMI-III base, in line of the CG Air G-1 to 2nd signal to.	
				1200 5 Sept 50
				1100 6 Sept 50
				UNMI-III, AREA
1800	1		-1 CG Air G-1 to 2nd signal to, , and 2nd.	1200 7 Sept 50
				1100 8 Sept 50
				UNMI-III, AREA
1800	2		Operations allowed by heavy rain.	
1700	3		CG Air G-1 to 2nd signal to via UNMI-III. 1st guard.	
0500	4		CG Air G-1 to 2nd signal to, evacuated 10. CG Air G-1 to 2nd signal to.	

G-1 JOURNAL

FROM: 1200 8 Sept 50

TO: 1159 9 Sept 50

PLAC: HAWAII, HONOLULU

TIME	No.	Time	INCIDENTS, MESSAGES, ORDERS, ETC.	ACTION TAKEN
1200	1		Continued rain.	
1330	2		Staff conf conducted by new C/S. No change in policies or procedures.	
1700	3		AS rptd that S.S. would be held at 081500K.	
0830	4		1st Lt. ... held at 081500K.	
<p style="text-align: right;">FROM: 1200 9 Sept 50 TO: 1159 10 Sept 50 PLAC: HAWAII, HONOLULU</p>				
1200	1		Weather clear.	
1330	2		1st Lt. ... held at 081500K.	
1700	3		AS rptd that S.S. would be held at 081500K.	
<p style="text-align: right;">FROM: 1200 10 Sept 50 TO: 1159 11 Sept 50 PLAC: HAWAII, HONOLULU</p>				
1200	1		Weather overcast but cool and air calm.	
1330	2		AS rptd that S.S. would be held at 081500K.	
1700	3		AS rptd that S.S. would be held at 081500K.	

G-1 JOURNAL

CONTINUED ON

FROM: 1500 10 Sept 80

TO: 1100 11 Sept 80

FROM: NAME - M, Korea

TIME	No.	INCIDENTS, MESSAGES, ORDERS, ETC.	ACTION TAKEN
1830	4	Col SANCHEZ, Army 8-1, via CF and conferred with Lt. COL and 8-1, ree current strength figures. They was made for white replacements and 8-1 and 8-2 servers. Col SANCHEZ indicated that said white replacements would be turn the 8-1.	
1830	5	Col SANCHEZ - 1 to 8-1 ree tech and 8-1 white with 8-1 w twards leaving them 10 of their personnel for trip to 8-1 and 8-2 for 8-1's center and 8-1 and 8-1 ree to 8-1.	
1830	6	Col SANCHEZ - 1 to 8-1 ree to 8-1.	
1830	7	Col SANCHEZ - 1 to 8-1 ree to 8-1 and 8-1 from 8-1 to 8-1 and 8-1.	
			FROM: 1500 11 Sept 80
			TO: 1100 11 Sept 80
			FROM: NAME - M, Korea
1830	1	8-1 alarm. 8-1, 8-1 and 8-1 ree 8-1 and 8-1 ree 8-1.	
1830	2	8-1 ree 8-1, 8-1 and 8-1 ree 8-1 and 8-1 ree 8-1.	
1830	3	8-1 ree 8-1, 8-1 and 8-1 ree 8-1 and 8-1 ree 8-1.	
1830	4	8-1 ree 8-1, 8-1 and 8-1 ree 8-1 and 8-1 ree 8-1.	
1830	5	8-1 ree 8-1, 8-1 and 8-1 ree 8-1 and 8-1 ree 8-1.	

G-1 JOURNAL

FROM: 1200 13 Sept 60

TO: 1100 13 Sept 60

PLANT: XXXXXXXXXX

TIME	No.	Time	INCIDENTS, MESSAGES, ORDERS, ETC.	ACTION TAKEN
1200	1		Weather clear.	
1230	2		3rd shift report: 1st shift 6 units.	
1300	3		Order for repair on #100 (2nd shift)	
0300	4		Unit advised to run on 300. Requested today as follows: 1st shift - 100; 2nd shift - 150; 3rd shift - 200.	
				FROM: <u>1200 13 Sept 60</u>
				TO: <u>1100 13 Sept 60</u>
				PLANT: <u>XXXXXXXXXX</u>
1300	1		300 units rec'd. 1st shift as follows: 3rd shift - 100; 2nd shift - 100; 3rd shift - 100.	
1300	2		Control unit #100's unit #1. Unit to discontinue use of unit. Unit control remained in 1st shift control.	
0300	3		Admin. department projected operation prepared for unit.	
				FROM: <u>1200 13 Sept 60</u>
				TO: <u>1100 13 Sept 60</u>
				PLANT: <u>XXXXXXXXXX</u>
1400	1		Weather report: 1st shift 6 units, 2nd shift 6 units.	
0300	2		Control unit #100's unit #1. Unit to discontinue use of unit. Unit control remained in 1st shift control.	
1300	3		Order for repair on #100 (2nd shift)	
1300	4		Unit advised to run on 300. Requested today as follows: 1st shift - 100; 2nd shift - 150; 3rd shift - 200.	

G-1 JOURNAL

FROM: 1200 16 Sept 50

TO: 1100 18 Sept 50

PLACER: NAME-1, 1000A

TIME	No.	INCIDENTS, MESSAGES, OFFERS, ETC.	ACTION TAKEN
0700	1	Mail out of air launched to air to NAME-1 by line.	NAME: 1200 16 Sept 50 NAME: 1100 17 Sept 50 NAME: NAME-1, 1000A
1000	1	Ord to P-51 for ref. to 1st Lt General P 1st Lt General.	NAME: 1200 17 Sept 50 NAME: 1100 18 Sept 50 NAME: NAME-1, 1000A
1400 1600	1 2	Gen. order revised. P. 1st Lt General. Proceeded to recon- struction.	NAME: 1200 18 Sept 50 NAME: 1100 18 Sept 50 NAME: NAME-1, 1000A
1430 1435	1 2	Col. name list to approach. He was visited by 1st Lt General. Reported the rear section and hospital patients.	
1400	3	-A periodic report dispatched to NAME-1	
1450	4	Col. name report to NAME-1	
1710	5	NAME-1 was closed in new NAME-1.	

UNIT

G-1 JOURNAL

DATE: 1200 18 Sept 50

TO: 1159 20 Sept 50

PLACE: MARKET, WY, WYOMING

TIME	No.	INCIDENTS, MESSAGES, ORDERS, ETC.	ACTION TAKEN
1800	1	Service UNIT-M closed. Service UNIT-N was opened.	
1830	2	Col Tanner arrived on the 1830 train.	
1830	3	It established a new area to be covered.	
1900	4	300 message re: (UH-130; 1st Party - 330)	
0900	5	Personnel received from CG for distribution.	
0930	6	Under (with a communication in 1830)	
1100	7	1st Party, 1st Party, and 1st Party with on rec maintenance of unit.	
		1st Party, 1st Party, 1st Party	
			TO: <u>1200 18 Sept 50</u>
			TO: <u>1159 21 Sept 50</u>
			PLACE: <u>MARKET, WY, WYOMING</u>
1530	1	Col Tanner and Col [unclear] discussed CG by letter on personnel matters.	
1830	2	Personnel matters discussed with in CG maintenance.	
2000	3	CG maintenance was discussed with personnel.	
			TO: <u>1200 18 Sept 50</u>
			TO: <u>1159 21 Sept 50</u>
			PLACE: <u>MARKET, WY, WYOMING</u>
1900	1	Col Tanner, [unclear] - [unclear]	
0900	2	Col Tanner, [unclear] - [unclear] on rec maintenance of [unclear] for [unclear]	
1000	3	Col Tanner discussed [unclear] maintenance.	
1100	4	Col Tanner reported for [unclear] personnel matters.	

G-1 JOURNAL

FROM: 1200 22 Sept 50

TO: 1159 23 Sept 50

PLACE: CHARLESTON, SC

TIME	No.	Title	ACTION TAKEN
1830	1	Tom Walker visited G-1	
0510	2	Ed Robinson w/ing Tom's apt for vid in reconnaissance of site	1200 27 Sept 50 1159 21 Sept 50
0900	1	Periodic report on development of situation - I.	1200 24 Sept 50 1159 23 Sept 50
1830	1	Periodic report on development of situation - I	1200 23 Sept 50 1159 22 Sept 50
0830	2	Ed Robinson and party visited site of reconnaissance for CP.	1200 23 Sept 50 1159 22 Sept 50
0700	1	Periodic report on development of situation - I	1200 22 Sept 50 1159 21 Sept 50
1730	2	Ed Robinson and party visited site of reconnaissance for CP.	1200 22 Sept 50 1159 21 Sept 50
0830	3	Ed Robinson and party visited site of reconnaissance for CP.	1200 22 Sept 50 1159 21 Sept 50

G-1 JOURNAL

FROM: 1200 27 Sept 50

TO: 1100 28 Sept 50

PLACE: Vic HYNOCCHI

TIME	No.	Time	INCIDENTS, MESSAGES, ORDERS, ETC.	ACTION TAKEN
1700	1		Inf personnel report sent to HQ. Rpt signed by Commandant General 2d Div.	
1800	2		Col Robinson rec'd from 2d reco battalion	
1810	3		List of staff and unit commanders sent to 1-1 Corps and HQ.	
0810	4		Advance order for new 2d Div ATFI	
1100	5		Division to be via AFI for new area via AFI.	
				FROM: 1200 28 Sept 50
				TO: 1100 29 Sept 50
				PLACE: Vic HYNOCCHI
1800	1		Inf report that 2d Div had captured 2nd Battalion 1st Div in 2nd Div.	
1810	2		Inf report that 2d Div had captured 2nd Battalion 1st Div in 2nd Div.	
				FROM: 1200 28 Sept 50
				TO: 1100 30 Sept 50
				PLACE: Vic HYNOCCHI
1700	3		Col 2d Div report received re 2d Div report of 2d Div activity report.	
1810	4		Inf report that 2d Div had captured 2nd Battalion 1st Div in 2nd Div.	
1820	5		Inf report that 2d Div had captured 2nd Battalion 1st Div in 2nd Div.	
1830	6		Inf report that 2d Div had captured 2nd Battalion 1st Div in 2nd Div.	
1840	7		Inf report that 2d Div had captured 2nd Battalion 1st Div in 2nd Div.	
				FROM: 1200 30 Sept 50
				TO: 1100 1 Oct 50
				PLACE: Vic HYNOCCHI
1800	1		Col 2d Div report received re 2d Div report of 2d Div activity report.	
1810	2		Col 2d Div report received re 2d Div report of 2d Div activity report.	
1820	3		Inf report that 2d Div had captured 2nd Battalion 1st Div in 2nd Div.	

C O N F I D E N T I A L

HEADQUARTERS
2d Infantry Division
APO 248 c/o Postmaster
San Francisco, California

26 September 1950

SUBJECT: Report on ROK Personnel

TO: Commanding General
Eighth Army

1. In reply to your msg CX 21786 KRO, 4 Sept 1950, the following report is submitted as of 262500 Sept 1950:

a. Number of ROK personnel assigned to 2d Infantry Division totals 5660. For breakdown see attached chart.

2. Combat Efficiency

a. The efficiency of the ROK soldiers as combat infantrymen continues to deteriorate in spite of this Division being on the offensive and pursuing the enemy. All three infantry regiments and the Division Artillery now report that they cannot profitably absorb any additional ROK Troops.

b. The combat efficiency of these soldiers is now estimated to be 10%.

3. In view of the stated opinions of my unit commanders, the low potential of these troops and the extended lines of communication now in effect, it is requested that, after receipt of 500 ROKs scheduled for delivery to this Division 28 September, no further ROK replacements be furnished to the 2d Infantry Division.

1 Incl:
Strength Chart

L. B. KNEISER
Major General, U. S. Army
Commanding

INCL #6

NUMBER OF ROW PERSONNEL ASSIGNED 2d INF DIV

	2		5th Sept	9th Sept	13th Sept	15th Sept	17th Sept	19th Sept	23rd Sept	25th Sept	29th Sept	TOTAL PRESENT FOR	
	20th Aug	1st Sept										DUTY	
9th Inf Regt	200	295		290	150	10		250	10		25	1230	767
23d Inf Regt		160	374		150	9	200		10			903	647
36th Inf Regt					200	4	200		10	200	25	639	535
Div Artillery	50					1	100	250	11	200		612	600
Recon				75		1			1			77	67
2d Engr Bn			100			2					99	201	173
2d Signal Co			25								25	50	49
Div Hq Co				25		1						26	26
2d LP Co		45				1						46	42
72d Tank Bn									1	75	75	151	148
2d CM									1	25	25	51	51
702d Ord Co								1			50	51	50
2d Med Co											75	75	72
TOTAL	250	500	499	390	500	29*	500	500	45*	500	399	4112	3235

*Denotes Officer personnel

HEADQUARTERS
2d Infantry Division
APO 248 o/o Postmaster
San Francisco, California

7 November 1950

SUBJECT: Activities Report for the Month of October 1950

TO: Commanding General
2d Infantry Division
ATTN: Div Historical Officer

I Narrative

The first day of October found all the units of the 2d Infantry Division in a comparatively stable situation, with a general mission of zone security. The zone of the Division extended from CHANGYONG along the Division route of advance across the Naktong, and northwest through CHONJU and KONJU, to the northern limit at NONSAN. The Division Command Post closed in Chonju on 1 October. The 38th Infantry was disposed in the Konju-Nonsan area, the 23d Infantry and Division Artillery Headquarters in the CHONJU area, the 9th Infantry in the ANUI area and the 65th RCT, having been attached to the Division was responsible for the zone east of the Naktong River. All units had zones of responsibility insuring the security of the entire MSR, with the added mission of patrolling to the flanks and other specific areas. The Division Rear, composed primarily of the AG and Unit Personnel Sections was in the process of moving from MIRYANG to CHONJU on 1 October. This movement was delayed considerably due to transportation difficulties brought about by the necessity of using rail facilities. This required the Division Rear installation to move by way of Pusan to ^{Yonju} Chinju by rail, and by truck transportation to Chonju. The advance detachment of the Rear arrived in Chonju the afternoon of 3 October, whereas the main body did not close in Chonju until the evening of 6 October. This delay also caused a temporary backlog of mail, replacements, and other administrative matters ordinarily processed in the Division Rear.

On 6 October the Division received orders to assemble in a designated area north of Suwon and south of Seoul and revert to Army Reserve. The Division Command Post closed in YONGDONGPO, south of Seoul, during the afternoon of 10 October. All Units of the Division were subsequently assembled in the reserve assembly area to await further orders. From this period until the latter part of the month, units were engaged primarily in conducting small unit training and care and maintenance of equipment.

At the close of the month, the Division Command Post had moved to PYONGYANG in accordance with Army orders changing the tactical mission of the Division from that of a reserve status to one of zone responsibility including the city of PYONGYANG and extending south to the city of SEOUL. The major units of the Division were disposed as follows: The 9th Infantry Regiment was assembled in PYONGYANG area. The 23d Infantry Regiment was assembled in the HAEGU-SARIWON area. The 38th Infantry Regiment, the Division Artillery (-), and the Division Rear remained in the YONGDONGPO-SEOUL area. The primary mission of the Division at the close of the month was one of area or zone security and the administration of civil affairs matters in the Provinces contained within the Division zone, including the city of PYONGYANG.

Personnel gains during the month of October exceeded the losses by 1401 men. The gains, including hospital returnees as well as replacements, totaled 1917 while the losses, composed primarily of non-battle casualties, totaled 516. All of the above figures reflect gains and losses of American personnel only. Only 19 ROK personnel were received during this month. These 19 soldiers were clerical and administrative personnel procured for the purpose of administering the personnel matters involving the ROK soldiers attached to units of the Division. At the close of the month the status of the ROK personnel was uncertain in that the higher headquarters had requested information as to whether or not the Division commander desired to retain the attached ROK personnel in the units. A levy for the release of 1059 ROK soldiers, against the Division had already been made earlier in the month. These men were returned to the ROK Army for reassignment within South Korean Army units. As to the desirability of retaining the remaining ROK soldiers (some 2,000) all unit commanders concurred in the desire to return their attached ROKs to the ROK Army and obtain American replacements.

During the month of October the military discipline within the 2d Division not only remained good but experienced quite an improvement due to the generally stable status of the units which afforded opportunity for a short period of semi-garrison standards of living. All military offenders of minor infractions have been handled in the lowest echelon of command. During this report period there were three Special Courts-Martial and two Summary Courts-Martial cases reported. In addition there were four cases of alleged rape charged against personnel of the Division. These cases were under complete investigation, however, only one case appeared to be founded on sufficient evidence to warrant charges. At no time during the month of October did a straggler problem exist.

During the period of this activities report there was a total of 3053 prisoners captured by units of the division and processed through Prisoner of War channels. The breakdown of Prisoners by capturing units is reflected in the attached personnel Periodic Reports.

Morale of the 2d Division has been exceptionally high throughout the month. The entire Division had just completed an unprecedented drive

of over 150 miles during the 10 day period prior to 1 October 50 and the esprit-de-corps was at its peak at this time. This fact combined with the chance to reassemble the units in a reserve assembly area for further training, care and maintenance of clothing and equipment, etc, materially added to the factors responsible for this high state of morale. The opportunity to locate the Division Rear installations in the immediate vicinity of troops also aided in prompt mail deliveries, available PX supplies and other welfare items. During this period entertainment features, both Korean and American show groups, were arranged for all troops. During the month of October the Commanding General of the 2d Infantry Division presented seventy four (74) Silver Stars, two hundred forty (240) Bronze Stars, fifty five (55) Distinguished Flying Crosses, two hundred eighty six (286) Air Medals, and one (1) Soldiers Medal. Also during this period recommendations for the award of three (3) Congressional Medals of Honor and seven (7) Distinguished Service Crosses had been submitted to higher headquarters. At the close of the month there remained on hand, yet to be processed by the Division A & D Board, recommendations for the award of forty two (42) Silver Stars, thirty (3) Bronze Stars, and one (1) Medal of Merit (Civilian). It is anticipated that many of the above recommended 42 Silver Stars will be reduced to Bronze Stars or returned to the originating source for further information.

Civil Affairs activities during the month of October were comparatively limited due to the period of organization required to establish Civil Assistance Officers, teams and the procedures and functions under which the newly established agency would operate. For a detailed report of the activities of the Civil Affairs Officer see personnel Periodic Report No 10 attached hereto.

II Problems Encountered.

There were no unusual problems which confronted the Administrative agencies of the Division during the month of October. In fact, the normal and routine administrative difficulties usually encountered in the field were held to a minimum due to the fact that the entire Division was consolidated in one area for a sufficient length of time to permit an intensity in the work output.

Throughout the month, as in the past months, the most serious problem confronting the G-1 section was the critical shortage of U. S. replacements for the losses suffered. In spite of continued emergency, as well as scheduled, requisitions for replacements, the Division remained short some 4400 men at the close of this report period. The primary and most critical shortage consisted of basic infantry riflemen. From the standpoint of officer shortages, the Division was not suffering to a critical degree, with the exception of Field Artillery Forward Observers.

III Solutions to Problems Encountered.

No satisfactory solution has been evolved concerning the problem

of obtaining U. S. loss replacements in a sufficient and continuous flow. This problem can only be solved at a higher level of command and is entirely contingent on the flow of replacements to the entire theater of operations and the priorities established by EUSAK headquarters.



6 Incls:

1. G-1 Periodic Report # 7
2. G-1 Periodic Report # 8
3. G-1 Periodic Report # 9
4. G-1 Periodic Report # 10
5. G-1 Journal (Month of Oct)
6. Report of ROK Personnel

JAMES D. TANNER
Lt Col GSC
AC of S G-1

Hq 2d Inf Div
APO 248 c/o FM, SF, Calif
031800 October 50

Personnel Periodic Report No 7
30 Sept to 7 October 50

Charts and Maps: KOREA, 1:50,000

1. SERVICES

a. During this report period, elements of the 2d Infantry Division have had the mission of mopping up areas bypassed as they advanced to the north. Elements of the 36th Inf had advanced to KONGJU, patrolling all flanking routes and approaches. The 13th Inf and 5th Inf Bde's continued their missions of securing the MSR from the NAKTOG River crossing to CHUNJU and patrolling all road nets leading into the MSR. The 68th Inf Bde was released from 2d Infantry Division control on 5 October 1950.

b. Replacements and returned gains during this period exceeded losses for the first time since the 2d Infantry Division began operations. Losses totaled 139 including KIA, battle and non-battle casualties while gains during replacement channels and hospital returns numbered 374.

c. No POW troops were received during this period.

d. For breakdown of strength, gains and losses within the Division see attached chart.

2. REPLACEMENTS

a. Acquisitions of personnel replacements have been submitted in accordance with Giv 31, HQ USAF dated 1 Sept 50. Number of replacements received is reflected in attached chart. Infantry replacements and heavy weapons men continue to be the critical shortage. Company grade field Artillery officers as forward observers is also a pressing requirement.

3. DISCIPLINE, LAW AND ORDER

a. Military discipline - excellent

b. Military offenders are being handled at the lowest echelon or combat, when appropriate. Three serious crimes involving personnel of the 2d Infantry Division have been reported during this period. Cases (rape) have been referred to Unit Commanders for appropriate action.

c. No straggler problem existed during this period.

4. PRISONERS OF WAR

a. Breakdown of prisoners of war by capturing organizations follows:

9th Infantry	438
25d Infantry	1168
38th Infantry	532
32d AAA AW	1
72d Tk Bn	19
2d Recon Co	2
506d Field Arty	68
59th Field Arty	3
2d Signal	7
TOTAL	2239

Prisoners of War have been treated according to the rules and regulations as set forth by the Geneva Convention of Aug. 1949.

5. PERSONAL AND SEASIDE RECREATION

Due to the rapid displacement north of the Division no report has been received of leisure during this period. Report for this period will be included in the next periodic report.

6. PERSONAL AND SEASIDE SERVICES

a. Excellent morale is enjoyed in all Divisional units.

b. Personal services - Pamphlets issued by the supply line are being received by all troops. The Division TX has not been in operation during this period due to the rapid movement of the units.

c. Postal services - Mail delivery has been excellent during this period. The forward APC and Division rear moving up to a more forward area has greatly expedited mail delivery.

d. Awards and Decorations - Recommendations are being processed by the A & B Board for the awarding of one (1) Congressional Medal of Honor, four (4) Distinguished Service Crosses, forty-two (42) silver stars, thirty (3) Bronze Stars and one (1) Medal of Merit.

7. CIVIL MATTERS

a. No refugee problem exists.

b. PROCEDURES

Administrative directives are published periodically. No change has occurred in procedures.

9. INTERIOR MANAGEMENT

Shelter throughout the Division area is adequate, consisting primarily of organizational tents. Structures are being used in some instances.

10. CIVILIAN EMPLOYEES

9th Infantry Regiment	15
23d Infantry Regiment	15
30th Infantry Regiment	15
Division Rear	50
Division Forward	52
2d Medical Bn	14
702d Ord Company	109
Division Artillery	23
21 Military Police Co	3
72d Heavy Train	17
21 CQ Co	10
TOTAL	328

2 Encls

1. Search the Report
2. Station List

JAMES H. DARRIN
Lt Col SSC
AC of S, 3-1

UNIT	STRENGTH			GAINS				GAINS		NOK		Actual
	Assigned			REFL	Ret urn	Total	Bat tles	N/EC	Tot al	Repl Return	Aggd	
	DET	EM	AGO									
Hq Fwd	42	71	113									
Hq Rr	31	117	149									
Hq Co	15	152	190								26	26
Div Med Det	2	12	14									
Div Arty	261	3151	3412	11	20	31	9	21	30	1	612	610
9th Inf Regt	131	2198	2329	23	150	155	10	36	46	20	1192	672
23d Inf Regt	134	2269	2405	12	44	56	9	28	37	16	903	624
38th Inf Regt	128	2446	2574	13	65	96	31	14	45	5	625	540
2d Med Bn	46	295	359	7	1	3		1	1		75	66
702d Ord	21	266	287		1	1		1	1		50	50
2d QM Co	14	215	229								50	50
2d Sig Co	17	337	374		2	2	3	2	5		50	49
72d Tk Bn	41	335	396	3	11	14	3	3	9		160	146
2d MP Co	8	172	180		3	3					36	41
2d Repl Co	9	54	43					2	2			
Band	2	93	95					2	2			
2d Engr Bn	37	743	735		7	7					200	176
2d Recon Co	5	130	135		3	3		1	1		77	63
TOTAL DIVISION	943	13232	14225	69	306	374	65	114	179	43	4056	3118
CIC DET	6	9	17									
ACG TO AL	951	13291	14242	69	306	374	65	114	179	43	4056	3118

Hq 2d Inf Div
APO 248 c/o FM, SF, Calif
8 Oct 50

STATION LIST

MAP: KOREA, 1:50,000

<u>UNIT</u>	<u>LOCATION</u>
96th INFANTRY REGIMENT	100.1-140.9
23d INFANTRY REGIMENT	100.8-145.7
38th INFANTRY REGIMENT	101.3-150.9
DIVISION ARTILLERY	102.1-145.0
15th FIELD ARTILLERY BN	100.1-145.7
37th FIELD ARTILLERY BN	100.8-145.7
38th FIELD ARTILLERY BN	101.3-150.9
508th FIELD ARTILLERY BN	102.1-145.0
82d AAA BN BATTALION	102.1-145.0
72d TANK BATTALION	100.8-145.7
2d ENGINEER BATTALION "C"	101.3-150.9
2d MEDICAL BATTALION	101.4-145.1
2d MEDICINE PACK COMPANY	101.4-145.1
2d QUARTERMASTER COMPANY	101.4-145.1
2d REUSE COMPANY	100.8-145.7
702d SIGNAL COMPANY	101.4-145.1
DIVISION HEADQUARTERS FORWARD	101.4-145.1
HEADQUARTERS COMPANY, 2d INF DIV	101.4-145.1
DIVISION HEADQUARTERS REAR	101.4-145.1
MEDICAL DETACHMENT, 2D INF DIV	101.4-145.1
2D SIGNAL COMPANY	101.4-145.1

Hq 2d Inf Div
APO 248 o/o FM, SF, Calif
151800 October 50

Personnel Periodic Report No 8
7 October 1950 to 14 October 1950

CHARTS AND MAPS, KOREA, 1:250,000

1. STRENGTHS

a. During this report period the mission of the 2d Infantry Division consisted primarily of patrolling the Division sector with no forward movement against enemy resistance. Movement of the entire Division into assembly area north of SUWON, where the Division became EUSAK reserve, closed on 13 Oct 50. Mission while in reserve assembly area primarily that of maintenance of equipment and training. No material change in strengths occurred during this report period.

b. Replacement and returnee gains during this period exceeded losses by a total of 353 men. Losses totaled 109 including battle and nonbattle casualties while gains through replacement channels and hospital returnees numbered 462.

c. A total of 19 ROK troops were received during this period. These ROK men are to be used as personnel and records clerks for ROK Personnel.

d. For breakdown of strength, gains and losses within the Division see attached chart.

2. REPLACEMENTS

a. Requisitions for personnel replacements have been submitted in accordance with Cir 31, Hq EUSAK dated 5 Sept 50. Number of replacements received is reflected in attached chart. Infantry riflemen and heavy weapons men continue to be the one critical shortage.

3. DISCIPLINE, LAW AND ORDER.

a. Military discipline - excellent

b. Military offenders are being handled at the lowest echelons of command when appropriate. Only one trial by courts-martial, Summary, being reported.

c. No straggler problem existed during this period.

4 PRISONERS OF WAR

a. Breakdown of prisoners of war by capturing organization follows:

9th Infantry Regiment	102
38th Infantry Regiment	45
37th Fld Arty Bn	2
38th Fld Arty Bn	1
82d AAA AW Bn	3
	<u>163</u>

Prisoners of war have been treated according to the rules and regulations as set forth by the Geneva Convention of August 1949.

5. BURIALS AND GRAVES REGISTRATION

a. A total of 15 internments all of which were identified. Identified burials included 15 from the 2d Infantry Division, 4 of which were ROK personnel. 2 known dead are pending identification of organization.

b. Enemy dead are being buried per instructions contained in Administration Order 26-A, Hq EUSAK dated 4 Sept 1950.

6. BURIALS AND PERSONNEL SERVICE

a. Excellent morale is enjoyed in all Divisional units. Class A rations being a tremendous factor in this.

b. Personnel Services - Gratuitous issue of PX Supplies are being received by all troops. Members of all units have the opportunity to avail themselves of three shower units and one laundry unit located centrally within the Division one. The Division PX has been moving forward to this location during this period and will be in full operation within the next report period.

c. Postal Service - Mail service has improved greatly during this period. The APO has been established at the Division forward CP with mail pickup and delivery from and to Kampo Airport expediting mail delivery to all units.

d. Awards and Decorations - Awarding of twelve Silver Stars, and forty-nine Bronze Stars have been approved by the A & D Board. Recommendations are being processed by the A & D Board for the awarding of four Distinguished Service Crosses, sixty one Silver Stars and eighty seven Bronze Stars.

7. CIVIL AFFAIRS

a. No refugee problem exists.

8. PROCEDURES

Administrative directives are published periodically. No change has occurred in procedures.

9. INTERIOR MANAGEMENT

Shelter throughout the Division zone is adequate, consisting primarily of organizational tentage. Structures are being used in some instances.

10. CIVILIAN EMPLOYEES

9th Infantry Regiment	15
23d Infantry Regiment	25
38th Infantry Regiment	15
Division Rear	50
Division Forward	50
702d Ordnance	43
Division Artillery	30
2d Military Police Co	8
72d Tank Battalion	20
2d Quartermaster Bn	10
TOTAL	216

2 Incls

1. Strength Chart
2. Unit Station List

JAMES D. TANNER
Lt Col GSC
AC of S, G-1

UNIT	STRENGTH			GAINS				LOSSES				ROCK	
	Assigned		AGG	Return		Total	Bat Non		Total	Repl	asgd	Actual	
	Off	EM		Repl	ees		tle	Battle					Return
Hq Fwd	42	71	113										
Hq Rr	30	117	147										
Hq Co	15	152	167		1	1		1				26	
Div Med Det	2	12	14										
Div Arty	230	5184	3414	5	34	39	13	14	27	1		689	
9th Inf Regt	138	2309	2447	55	115	170		34	34	72	1386	725	
23d Inf Regt	138	2342	2480	29	62	91		4	4	18	904	632	
38th Inf Regt	134	2541	2675	38	91	129	2	17	19	3	639	541	
4d Med Bn	45	294	339	1	1	2		1	1	6	75	72	
702d Ord	21	268	289		2	2		1	1		51	51	
2d QM Co	13	218	231	1	3	4	1	1	2		51	50	
2d Sig Co	17	358	375		2	2				1	50	49	
72d Tk Bn	41	553	594		5	5	5	11	16		152	145	
2d MP Co	8	173	181		4	4		3	3	1	46	42	
2d Repl Co	9	34	43										
Band	2	91	93										
2d Engr Bn	41	758	799		14	14					202	178	
2d Recon Co	5	132	137		3	3		1	1		77	66	
TOTAL DIVISION	931	13608	14539	129	333	462	21	88	109	102	4121	3186	
CIC Det	8	8	16										
AGG TOTAL	939	13606	14555	129	333	462	21	88	109	102	4121	3186	

Incl # 1

Hq 2d Inf Div
APO 248 c/o FM, SF Calif
16 Oct 50

STATION LIST

MFA: KOREA, 1:250,000

<u>UNIT</u>	<u>LOCATION</u>
9th Infantry Regiment	CS1236
23d Infantry Regiment	CS2244
38th Infantry Regiment	CS1449
Division Artillery	CS1641
15th Field Artillery Battalion	CS1641
37th Field Artillery Battalion	CS1742
38th Field Artillery Battalion	CS1642
503d Field Artillery Battalion	CS1642
82d AAA AW	CS1542
72d Tank Battalion	CS1848
2d Engineer Battalion "C"	CS1548
2d Medical Battalion	CS1641
2d Military Police Co	CS1652
2d Quartermaster	2528CS
2d Reconnaissance	CS1652
702d Ordnance	CS1848
Division Headquarters Company	CS1652
Division Headquarters Forward	CS1652
Division Headquarters Rear	CS1652
Medical Detachment	CS1652
2d Signal	CS1642

Hq 2d Inf Div
APO 248 c/o ILL, SF, Calif
21 Oct 50

Personnel Periodic Report No 9
141800 to 211800 Oct 50

1. STRENGTH

a. During this report period the 9th Infantry and 23rd Infantry Regiments were reconstituted as Regimental Combat Teams. The 9th BCT upon reorganization was attached to I Corp and moved to the vicinity of MANAGAPAN. At 0001 on 19 Oct, the Division was released from Eighth Army reserve and attached to I Corps. On the following day the 23rd BCT moved to the vicinity of BANGUI sending one BCT north to SARIWON and one to CHAMBERNS. Task force Indianhead was organized by direction of G-2 Eighth Army and placed under operational control of BUSAI to be used as a target force in PYAWA C. The 30th Infantry Regiment carried on with equipment maintenance and troop training together with the balance of the Division in the SAKAL area.

b. Replacement and returned gains during this period exceeded losses by a total of 170 men. Losses totaled 106 all of which were non battle casualties while gains through replacement channels and hospital returns numbered 262.

c. Casualties - A recapitulation of the Division total casualties to date is attached as enclosure No 3.

d. No R&I personnel received during this period. Authorization was received to reduce the number of R&I to 25 per company for a total of 2075 in the Division. Action was being taken at the close of the period to effect this reduction.

e. For breakdown of strength, gains and losses within the Division see attached chart (enclosure 1)

2. REPLACEMENTS

Requisitions for personnel replacements have been submitted in accordance with Cir 31, HQ USAF dated 6 September 50. Number of replacements received is reflected in attached chart. In infantry rifleman and heavy weapons men continue to be the one critical shortage.

3. DISCIPLINE, LAW AND ORDER

a. Military discipline - excellent

b. Military offenders are being handled at the lowest echelons of command when appropriate. No trials by court-martial being reported during this period. One alleged rape case was investigated.

4. PRISONERS OF WAR

a. Breakdown of prisoners of war by capturing organization follows:

9th Infantry Regiment 29

b. Prisoners of war have been treated according to the rules and regulations as set forth by the Geneva Convention of August 1949.

5. BURIALS AND GRAVES REGISTRATION

a. No record of burials received during this period.

b. Enemy dead are being buried per instructions contained in Administration Order 20-A, HQ EUSAAC dated 4 September 1950.

6. MOORALE AND PERSONNEL SERVICE

a. Excellent morale is enjoyed in all Divisional units. Class A rations being a tremendous factor in this.

b. Personnel services - Gratuitous issue of some basic PX supplies are being received by all troops. Members of all units have the opportunity to avail themselves of shower and laundry facilities, located in their respective areas. The Division PX has been in operation during this period with goods not included in gratuitous PX rations available to all personnel of the Division. However, the PX is unable to purchase additional cigarettes, candy, soap, and other items which are inadequate on the gratuitous issue and which all units are requesting. This is being taken up separately with the 14th Air Army. A small gift shop handling American and native wares is also in operation at the Division CP.

c. Postal service - Mail service has been adequate but sporadic, due to transportation difficulties. Postal money order and package mailing facilities are available to all units.

d. Awards and Decorations - Awarding of 17 Silver Stars, 55 Distinguished Flying Crosses, 1 Soldiers Medal, 150 Bronze Stars, 236 Air Medals have been approved by the A & B Board. Recommendations for 2 Congressional Medals of Honor, 3 Distinguished Service Crosses and 1 Iron Cross for Air Force Personnel have been forwarded to higher headquarters for approval. To date 77 Silver Stars, 220 Bronze Star Medals, 1 Army Commendation Ribbon, 306 Air Medals, 55 Distinguished Flying Crosses and 1 Soldiers Medal have been awarded to officers and men of this Division. ✓

7. CIVIL AFFAIRS

a. Civil Affairs sections have been organized on a Division

and a Regimental level in accordance with message GK 25719 Headquarters EUSAK dated 10 October 1950. They are now in the initial stages of organization.

9. PROCEDURES

Administrative directives are published periodically. No change has occurred in procedures.

10. INTERIOR MANAGEMENT

Shelter throughout the Division zone is adequate, consisting primarily of organizational tents. Structures are being used in some instances.

10. CIVILIAN EMPLOYEES

9th Infantry Regiment	15
25th Infantry Regiment	25
38th Infantry Regiment	136
72d Tank Battalion	22
Division Hq Company	33
Military Police Company	20
Division Rear	50
Division Forward	50
702d Ordnance Company	18
Division Artillery	<u>30</u>

TOTAL 406

3 Incls:

1. Strength Chart
2. Unit Station List
3. Casualty Recapitulation List.

JAMES D. BAKER
Lt Col GSC
AC of S, C-1

UNIT	STRENGTH			GAINS			LOSSES		ROK			
	Assigned		Agg	Repl	Retur nees	Total	Bat Tlo	Non B/C	Total	Repl & Return	Asgd Actual	
	Off	EM										
Hq Fwd	43	70	113									
Hq Rear	28	130	158									
Hq Co	15	151	166	1		1		1	1	26	26	
Div Mod Det	2	12	14									
Div Arty	231	3184	3415	18	26	44		30	30	612	209	
9th Inf	145	2354	2509	22	64	86		19	19	41	1230**	757
23d Inf	151	2340	2491	9	25	34		18	18	22	903*	647
38th Inf	158	2563	2721	28	56	84		23	23	9	639	538
2d Med Bn	44	287	331	1		1		3	3	1	75	72
702d Ord	21	266	287	3		3		3	3		51	50
2d QM Co	13	218	231							1	51	51
2d Sig Co	17	363	380	2		2					50	49
72d Tk Bn	42	554	596	5	5	10		1	1	1	151	146
2d MP Co	9	169	178	1		1		1	1	1	46	42
2d Repl Co	9	34	43									
Band	2	91	93									
2d Engr Bn	41	762	803	4	6	10		6	6		201	174
2d Recon Co	7	136	143	2	4	6				1	77	67
TOTAL DIVISION	978	13674	14652	93	189	282		106	106	77	4112	3228
CIC Det	8	8	16									
AGG TOTAL	986	13682	14668	93	189	282		106	106	77	4112	3228

* 160 ROK atchd to 23d Inf from 9th Inf

INCL # 1

SECRET

Hq 2d Inf Div
APO 248 c/o FM, SF, Calif
211800 Oct 50

STATION LIST

MAP: KOREA 1:250,000

UNIT

LOCATION

9th Infantry Regiment	YD4124
23d Infantry Regiment	CS2244
36th Infantry Regiment	CS1449
Division Artillery	CS1641
15th Field Artillery Battalion	YD4124
37th Field Artillery Battalion	CS2244
38th Field Artillery Battalion	CS1642
503d Field Artillery Battalion	CS1642
2 AAA AF	CS1542
72d Tank Battalion	CS1548
2d Engineer Battalion "C"	CS1348
2d Medical Battalion	CS1641
2d Military Police Co	CS1652
2d Quartermaster	CS2528
2d Reconnaissance	YC4035
702d Ordnance	CS1348
Division Headquarters Company	CS1852
Division Headquarters Forward	CS1852
Division Headquarters Rear	CS1852
Medical Detachment	CS1852
2d Signal	CS1642

SECRET

Hq 2d Inf Div
APO 248 a/c PH, SF, Calif
31 Oct 50

Personnel Periodic Report No 10
211800 Oct 50 to 311800 Oct 50

1. STRENGTHS

a. During this report period the 2d Division reverted to EUSAK Reserve from I Corp control. The 9th RCT reverted to operational control of 2d Division and Task Force Indianhead was dissolved. The 187th Airborne RCT was attached to this Division and was assigned missions of occupying and securing airfields in the vicinity of Pyongyang. The 9th RCT occupied and secured city of Pyongyang and initiated plans for the rehabilitation of and establishing civil government for the city of Pyongyang. At the close of this period the 9th RCT was relieved of its missions in Pyongyang by the 187th RCT and moved to the vicinity of Sunchon. 187th to further secure and occupy the port of Chinampo. The 23rd RCT was assigned mission of patrolling the MSR from Eneju N through Sinwon N, and Sariwon inclusive and East from Sariwon through Sohung, Sinmak and Hanchonjon inclusive in addition to patrolling within its zone of responsibility. The 58th RCT was to continue its present mission and to prepare to move to designated zone of responsibility on order. All units this division were to assume responsibility for civil affairs and establishment of local governments within their assigned areas.

b. Replacement and returnee gains during this period exceeded losses by a total of 667 men. Losses totaled 122 all of which were non battle casualties while gains through replacement channels and hospital returnees numbered 779.

c. Casualties - a recapitulation of the division total strengths and casualties is attached as inclosures number 1 and 2.

d. No ROK personnel were received during this period. A total number of 1059 ROK troops were returned to the Korean Army during this period per instructions of EUSAK Headquarters.

2. REPLACEMENTS.

Requisitions for personnel replacements have been submitted in accordance with Cir 51, Hq EUSAK dated 5 September 50. Number of replacements received is reflected in attached chart. Infantry riflemen and heavy weapons men continue to be the one critical shortage.

SECRET

3. DISCIPLINE, LAW AND ORDER.

a. Military discipline - excellent

b. Military offenders are being handled at the lowest echelons of command when appropriate. Three trials by Special and one trial by Summary Courts Martial were reported during this period.

4. PRISONERS OF WAR.

a. Breakdown of prisoners of war by capturing organization follows:

9th Infantry Regiment	-	138
23rd Infantry Regiment	-	254
38th Infantry Regiment	-	1
37th Field Artillery Bn	-	227
02d AAA Av Bn	-	6
TOTAL		<u>626</u>

b. Prisoners of war have been treated according to the rules and regulations as set forth in the Geneva Convention of August 1949.

5. BURIALS AND GRAVES REGISTRATION

No burials reported during this period.

6. MORALE AND PERSONNEL SERVICES.

a. Excellent morale is enjoyed in all divisional units.

b. Gratuitous issue of some basic PX supplies are being received by all troops. Shower and laundry facilities are available to all units in the Division. Movies are available nightly to all personnel. The Division PX has been in operation during this period with goods not included in the gratuitous PX ration available to all personnel in the Division. The gift shop established during the last report period is continuing to operate.

c. Postal service continues to be adequate but sporadic due to transportation difficulties. Postal money orders and package mailing facilities are available to all units.

d. Awards and Decorations - During this period a total of 45 Silver Stars and 61 Bronze stars were awarded to Division personnel.

7. CIVIL AFFAIRS

a. During the period covered by this report, Civil Assistance Teams were operating in the provinces of Pyongan Namdo and

RET

Hwanghae Do. Civil Assistance Team of the 9th RCT, headquarters Pyongyang, relieved the 5th Cav Regt of Civil Assistance responsibility for Pyongan Namdo, and the Civil Assistance Team of the 23d RCT, headquarters Inoju, assumed responsibility for Civil Assistance in Hwanghae Do. On 26 October, the Division Civil Assistance Officer issued general instructions for the administration of civil assistance activities within the Division area of responsibility. (On 29 October 50, Division CP moved from Yongdungpo to Pyongyang.) Instructions were received from USARV on 29 October that a Civil Assistance Team from USARV was attached 2d Infantry Division for assisting in the administration of civil assistance in the Province of Pyongan Namdo and to insure some continuity in this work when the 2d Infantry Division moved on. The 9th Infantry Civil Assistance Team was made responsible for the City of Pyongyang and its Civil Assistance Officer became the Executive Officer of the Army Team Commander. In both provinces, persons were being screened for suitability for assignment as interim governmental officials. In Pyongyang, a mayor and bureau chiefs had been appointed by the Civil Assistance Officer, I Corps. In Hwanghae Do, a provincial governor and bureau chiefs were selected and approved, and City Governments were set up in Inoju, Sariwon and Chaeryong. Surveys were being made concerning amount of food on hand, medical supplies, number of doctors, number of hospitals available and sustenance requirements. Fragmentary reports to USARV were made on these conditions and investigation continued.

8. PROCEDURES

Administrative directives are published periodically. No change has occurred in procedures.

9. HOUSING MANAGEMENT

Area commanders have been authorized to house troops in permanent type shelter wherever possible. Accomplishment of a unit's mission being the deciding factor in housing.

10. CIVILIAN EMPLOYEES

9th Infantry	15	2d QM Bn	10
23rd Infantry	25	702d Ord Bn	36
36th Infantry	130	Div Hq Co	33
Division Artillery	50	Div Forward	50
2d MP Co	19	Div Rear	50
72d Tank Bn	31	TOTAL	256

4 Incls

1. Unit Strength and Loss
2. Unit Gains and Losses
3. Daily Strength (31 Oct 50)
4. Battle & Non-battle Casualty Recap

JAMES D. TAMMIE
Lt Col CSC
Asst C of S G-1

SECRET

UNIT STRENGTHS AND LOCATION
AT CLOSE OF PERIOD

<u>UNIT</u>	<u>AUTH</u>	<u>ACTUAL</u>	<u>LOCATION</u>
9th Inf Regt	3735	2704	PTIKOVYANG YD3020
25th Inf Regt	3735	2692	HABU YC4012
58th Inf Regt	3735	2772	YUNSOONG* PO CS1862
Division Arty	3885	3451	YUNSOONG* PO CS1862
72d Genl Bn	681	610	ANJANG CS1541
2d Engr Bn	977	821	PTIKOVYANG YD4022
2d Med Bn	341	353	PTIKOVYANG YD4022
2d MP Co	187	170	PTIKOVYANG YD4022
2d Recon Co	252	146	PTIKOVYANG YD4022
2d QM Co	171	236	HABU YC4012
703d Ord Co	321	295	PTIKOVYANG YD4022
2d Div Band	70	69	PTIKOVYANG YD4022
2d Signl Co	34	51	CARIBU YC4005
Div Hq Co	100	168	PTIKOVYANG YD4022
Hvy Sq	253	255	PTIKOVYANG YD4022
Signal Co	309	378	PTIKOVYANG YD4022
Med Det (HQ)	14	14	PTIKOVYANG YD4022
TOTAL DIVISION	18914	15274	
ATTACHED:			
107 ABN BCT	4404	4565	PTIKOVYANG YD4022
2d CIC	17	16	PTIKOVYANG YD4022
AGGREGATE TOTAL	23355	19855	

Incl 1

SECRET

SECRET

UNIT DATES AND DATES SERVICE PERIOD

<u>UNIT</u>	<u>REPL</u>	<u>WARS</u>	<u>TOTAL</u>	<u>LOSSES</u>		<u>TOTAL</u>
				<u>BATTLE</u>	<u>NON BATTLE</u>	
9th Inf Regt	279	51	330	X	38	38
23d Inf Regt	157	61	218	X	22	22
38th Inf Regt	17	71	88	X	30	30
Div Artillery	34	37	71	X	18	18
72d Tank Bn	10	5	24	X	0	0
2d Eng Bn	3	15	18	X	X	X
2d Med Bn	3	1	4	X	1	1
2d LP Co	2	X	2	X	X	X
2d QS Co	5	X	5	X	X	X
2d Rec Co	X	X	X	X	1	1
703d Ord Co	3	5	10	X	1	1
2d Div Band	X	X	X	X	X	X
2d Engr Co	X	X	X	X	X	X
Div Hq Co	1	3	4	X	X	X
Division Hq	6	2	8	X	X	X
2d Signal Co	X	1	1	X	3	3
Med Det HQ	X	X	X	X	X	X
TOTAL DIVISION	527	253	779	0	122	122
ATTACHED:						
137 ADN BCT	234	05	319	X	X	X
2d CIC	X	X	X	X	X	X
AGGREGATE TOTAL	761	333	1098	X	122	122

SECRET

1/3 STRENGTH AS OF
29 October 1950

	<u>T/O</u> <u>Auth</u> <u>Str</u>	<u>Assigned</u> <u>1/3</u> <u>Str</u>	<u>Actual present</u> <u>Duty Strength</u>	<u>Duty Strength</u> <u>Over</u> <u>Base</u>
Hq & Hq Co	330	352	331	1
Band	60	89	67	19
2d MP Co	100	168	167	15
702d Ordnance Co	302	278	273	29
2d QM Co	240	222	207	33
2d Signal Co	354	358	353	2
2d Repl Co	34	234	116	62
2d Rem Co	164	132	132	32
9th Infantry	3014	2699	2373	1241
23d Infantry	3014	2602	2427	1167
30th Infantry	3014	2944	2299	1325
72d Tank Bn	650	575	561	77
2d Medical Co	235	266	284	0
2d Engr C Bn	927	735	730	177
Hq & Hq Btry Div Arty	106	104	140	50
15th FA Bn	621	590	560	38
37th FA Bn	621	573	562	59
38th FA Bn	621	530	575	46
603d FA Bn	624	614	598	42
62d AAA AV Bn	<u>735</u>	<u>650</u>	<u>652</u>	<u>63</u>
TOTALS	17789	14623	13463	104 4441

Incl # 3

4441
104
4337

G-1 JOURNAL

FROM: 1200 1 Oct 50

TO: 1159 2 Oct 50

THRU: via COMNAV

SECRET

TIME	No.	INCIDENTS, MESSAGES, ORDERS, ETC.	ACTION TAKEN
1530	1	Div closed in New Orleans of COMNAV	
1630	2	Col Tammert left for COMNAV by air for information concerning report of Lt. Col.	
1159	3	Col Tammert ret'd from COMNAV. He had left for COMNAV at 0830 and by rail and Lt. Col. Tammert, was bivouaced in HAWAII. COMNAV Div office was in opn.	
			FROM: 1200 2 Oct 50
			TO: 1159 3 Oct 50
			THRU: via COMNAV
1600	1	C-1 Weekly Personnel Periodic Report to be sent to HAWAII B-1 plane.	
1630	2	Classified 1000 and rec'd from II Corps. Admin Order as follows.	
1620	3	Adjutant General's Office to be reorganized for buildings to be utilized by II Corps and I Corps. See also file of HAWAII.	
1645	4	Schedule for daily courier run by plane to HAWAII (at 1600) attached. (via COMNAV) drafted.	
1600	5	Div staff called to see Col Tammert regarding visit of 07 hours on to HAWAII from II Corps Co.	
1630	6	Col Tammert -1, Adjutant, visited C-1.	
			FROM: 1200 3 Oct 50
			TO: 1159 4 Oct 50
			THRU: via COMNAV
1610	1	Adjutant General's Office reorganization plan received by 0800 and arrived at HAWAII.	
1630	2	Adjutant General's Office, visited C-1.	
1700	3	Recommendation to HAWAII for order issued and advice and consent drafted and attached to CO. Distributed to company level.	

G-1 JOURNAL

FROM: 200 5 Oct 50

TO: 1159 5 Oct 50

PLACE: Vic CHUNJU

TIME	No.	INCIDENTS, MESSAGES, ORDERS, ETC.	ACTION TAKEN
0730	1	Receipt of total no of prisoners taken by 2d Inf Div - 3,000.	
0810	2	Col Lanner ret'd. via C-119 by plane for conference with Col Meter, AG.	
1120	3	3 officers ret'd. for transportation to CHUNJU where they will be held w/AG's staff. REF: 115-1-2 08 2 50.	
		FROM: 1200 5 Oct 50	
		TO: 1159 5 Oct 50	
		PLACE: Vic CHUNJU	
1255	1	Col Lanner ret'd. reported difficulty with the rail service between CHUNJU and CHUNJU resulting in a stacking of rail cars, empties, and a pile-up of empty trucks waiting for the train to bring all the supplies. 15 empty trucks were directed to be moved from the rail yard to CHUNJU and trucks were to be used to assist in the move.	
1300	2	Mr. R. J. ... and signed by ... since ... in	
2130	3	...	
2130	4	...	
0300	5	...	
1000	6	...	

G-1 JOURNAL

FROM: 1200 6 Oct 50

TO: 1135 7 Oct 50

PLACED: 1135 0000H

TIME	No.	INCIDENTS, MESSAGES, ORDERS, ETC.	ACTION TAKEN
1300	1	Adv. US dept'd b air for arranged in to attempt procurement of moving pic- ture and film, athletic equipment, stationery etc. Also carried - request for auth to issue orders to send 1 officer to Japan for class supplies.	
1500	2	Adv. Jensen and party returned from rec- telligence.	
1700	3	Adv. returned from W. F. and request for 1st order.	
1800	4	Adv. later called to report on collected info on North all ins. trucks of ar. sch. Order due in by 2200.	
1900	5	Adv. held con. of collect. in chiefs re: operations order.	
			FROM: 1200 7 Oct 50
			TO: 1135 7 Oct 50
			PLACED: 1135 0000H
1000	1	Advance 1 group left via BU. N.	
			FROM: 1200 8 Oct 50
			TO: 1135 8 Oct 50
			PLACED: 1135 0000H
1800	1	Advance 2. step of Apr. in Pacific	
2000	2	Advance 1. step of Apr. in Pacific	
			FROM: 1200 8 Oct 50
			TO: 1135 10 Oct 50
			PLACED: 1135 0000H
1630	1	Advance 1. arrived via BU. N.	
1630	2	Per office report to 7 sent to	
1630	3	Advance 1. left via BU. N.	

G-1 JOURNAL

FROM: 1200 10 Oct 50TO: 1159 11 Oct 50THRU: vic CANTINI

SECRET

TIME	No.	INCIDENTS, MESSAGES, ORDERS, ETC.	ACTION TAKEN
1430	1	Adv. arrival via WNC-231 and established in former school building.	
1510	2	entire division forward established via WNC-231.	
0830	3	Unit Station 1st dispatched to IX Corps per instr from 11, II Corps.	
			FROM: <u>1200 11 Oct 50</u>
			TO: <u>1300 12 Oct 50</u>
			VIC: <u>WNC-231</u>
1050	1	name withheld of personnel and equip in 10 Co. and 10 Co personnel.	
			FROM: <u>1200 12 Oct 50</u>
			TO: <u>1100 13 Oct 50</u>
			VIC: <u>WNC-231</u>
0830	1	Col Turner left for ...	
1140	2	Col Turner ret'd from ...	
1150	3	Col Turner left for ...	
			TO: <u>1200 13 Oct 50</u>
			TO: <u>1100 14 Oct 50</u>
			VIC: <u>vic WNC-231</u>
1430	1	Col Turner (231) visited ...	
1450	2	soldier brought into ...	
1510	3	Col Turner reported for ... via plane.	
1510	4	Col Turner returned from ...	
1630	5	Col Turner returned from ...	
1700	6	Col Turner ...	
0830	7	2 men soldiers turned over to ...	

G-1 JOURNAL

FROM: 1200 15 Oct 50

TO: 1100 18 Oct 50

THRU: 1200 16 Oct 50

TIME	No.	Time: Incidents, Messages, Orders, Etc.	Action Taken
1400	1	23d and 1st and entertained troops of 23d Inf Regt in their bivouac area.	<p>Time: <u>1200 15 Oct 50</u></p> <p>Time: <u>1100 18 Oct 50</u></p> <p>THRU: <u>1200 16 Oct 50</u></p>
1500	1	23d and 1st entertained troops of 23d and 1st in their bivouac area.	
0400	2	Adj. Robinson reported to reconnoiter area for new bivouac location and unit assembly area.	<p>Time: <u>1200 16 Oct 50</u></p> <p>Time: <u>1100 17 Oct 50</u></p> <p>THRU: <u>1200 16 Oct 50</u></p>
1700	1	Adj. Robinson returned for reconnoiterance.	
2100	2	111 Army Entertainment Group (and 1st company) entertained at bivouac.	
0200	3	Adj. Robinson party 23d and 1st Corps.	<p>Time: <u>1700 16 Oct 1950</u></p> <p>Time: <u>1100 17 Oct 50</u></p> <p>THRU: <u>1200 16 Oct 50</u></p>
1500	1	Adj. Robinson reported to reconnoiterance.	
1900	2	Adj. Robinson party 23d and 1st Corps.	
0200	3	Adj. Robinson party 23d and 1st Corps.	

LOG JOURNAL

DATE: 12.0 13 Oct 50

TO: 1159 13 Oct 50

PLACE: YONGBONG PO

TIME	IN	OUT	No.	Time	INCIDENTS, MESSAGES, ORDERS, ETC.	ACTION TAKEN
1000			1		RCM personnel report sent to 4-3 TUSAM.	
1100			2		Request to Staff Section Chiefs to submit names of personnel deserving awards.	
1110			3		Mag Robinson made 4-1 visit to all units, in vicinity of Division area.	
					FROM: 12.0 13 Oct 50	
					TO: 1159 20 Oct 50	
					PLACE: YONGBONG PO	
0900			1		Mag Robinson left for reconnaissance of new CP area.	
					FROM: 12.0 20 Oct 50	
					TO: 1159 21 Oct 50	
					PLACE: YONGBONG PO	
1000			1		1. From 4-3 with 4 troops to 4-1 for company.	
					FROM: 12.0 21 Oct 50	
					TO: 1159 22 Oct 50	
					PLACE: YONGBONG PO	
1300			1		Col Turner and Staff Sec. Martin.	
					FROM: 12.0 22 Oct 50	
					TO: 1159 23 Oct 50	
					PLACE: YONGBONG PO	
0.10			1		Col Turner in 4-3 staff meeting.	
1130			2		Mag Parks (RCM Liaison) submitted copy of RCM Officers attached to 4-3 Div.	

G-1 JOURNAL

FROM: 1200 23 Oct 50

TO: 1159 24 Oct 50

PLANS: XXXXXXXXXX

TIME	No.	Time	INCIDENTS, MESSAGES, ORDERS, ETC.	ACTION TAKEN
1400	1		Check for edic report submitted to [redacted]	
1400	2		"No Hope" show conducted in [redacted] (trans for units of the [redacted] furnished by units attending.)	
2000	3		1500 Corp order in release of a [redacted] national police received.	
2100	4		1500 Corp report with 3 officers contact investigation of war atrocities.	

FROM: 1200 24 Oct 50

TO: 1159 25 Oct 50

PLANS: XXXXXXXXXX

No entry

FROM: 1200 25 Oct 50

TO: 1159 26 Oct 50

PLANS: XXXXXXXXXX

No entry

FROM: 1200 26 Oct 50

TO: 1159 27 Oct 50

PLANS: XXXXXXXXXX

1300

1300

1

2

Personnel report dispatched to [redacted].
 Pl, 7-1 drug items laboratory to expected
 pro.

FROM: 1200 27 Oct 50

TO: 1159 28 Oct 50

✓ 0400

0400

1

2

1159 call via [redacted] closed; 11 started moving north to via [redacted] Div. Ernest J. C. Parrellol

PLANS: XXXXXXXXXX

G-1 JOURNAL

FROM: 1200 29 Oct 50

TO: 1159 29 Oct 50

PLACE: PYONGYANG

TIME	No.	Time, 1st	INCIDENTS, MESSAGES, ORDERS, ETC.	ACTION TAKEN
1645	1		Div Blvd closed into CP	
0800	2		Col received from 8th Army	
0810	3		Col Tanner departed to 8 Army, also visited Airfield at PYONGYANG.	
1130	4		Col Tanner returns from Army	
				FROM: 1200 30 Oct 50
				TO: 1159 30 Oct 50
				PLACE: PYONGYANG
1800	1		Copies of Army Air Order to 2nd Sections. 1 copy sent to Col Peter (18)	
	2		1st sent to C-534 Air Landing returning surplus of troops to us via AT new direction at 1800. Otherwise ship to US I by truck, not later than 31 Oct 50 and notify div and 8th Army of number and 2nd. signed Col Tanner.	
1130	3		Col Tanner to 2nd to Air at 1130, troops.	
				FROM: 1200 30 Oct 50
				TO: 1159 31 Oct 50
				PLACE: PYONGYANG
1810	1		Stockpile prepared for 2nd, 3rd, 4th, 5th: 17	
1900	2		Good collection of 1st 1st: 1st ship a card given to 1st 1st: 1st 1st 1st the troops. Report 1st 1st 1st 1st 1st at 1st 1st side. At 1st 1st 1st 1st necessary as 1st 1st 1st.	

C O N F I D E N T I A L

HEADQUARTERS
2d Infantry Division
APO 248 c/o Postmaster
San Francisco, California

26 October 1950

SUBJECT: ROK Personnel Report

SECRET

TO: Commanding General
Eighth Army

1. Number of ROK personnel assigned to the 2d Infantry Division totals 4112 as of 262400 October 1950. For breakdown by unit and present for duty strengths see attached chart.

2. Combat Efficiency

a. Intensive training programs were initiated by all units during this period in an effort to raise the efficiency of the ROK soldiers to a level approaching that of US troops. Due to two Regimental combat teams being assigned other specific missions by higher headquarters their training programs did not materialize. Consequently the efficiency of the bulk of the ROK soldier as a combat infantryman cannot be determined but is believed to have risen. The remainder of this command through its training program has increased the ROK troop effectiveness for future combat operations to an estimated 20-25% (See IIC report attached as Inclosure 1).

3. ROK personnel assigned to service units of the Division continue to be satisfactorily utilized although their presence in most units is not desired.

4. Instructions contain a message received from Commanding General 8th Army dated 21 October 50 concerning the reduction in the strength of ROK personnel assigned this Division has been complied with and 1088 ROKs are available for transfer back to the 8th Army, leaving 2075 assigned to this Division.

FOR THE ASSISTANT CHIEF OF STAFF:

2 Incls:

1. IG Report
2. Strength Chart
for ROKs Ascd to
Division

G. F. RECAN
Capt - AGC
Asst Adj Gen

C O N F I D E N T I A L

INCLOSURE #6

NUMBER OF ROK PERSONNEL ASSIGNED TO 2d INFANTRY DIV

	20 Aug	1st Sept	5th Sept	10th Sept	15th Sept	15th Sept	17th Sept	19th Sept	23d Sept	25th Sept	TOTAL	PRESENT FOR DUTY
9th Inf	200	455		130	150	10		250	9		1204	702
23d Inf			375	160	150	9	200		10		904	696
38th Inf					200	4	200		10	200	614	527
Div Arty	30					1	100	250	11	200	612	611
2d Engr Bn			100			2					102	89
2d Recon				75		1			1		77	68
Hq Co				25		1					26	26
2d Signal Co				25							25	25
2d MP Co		45				1					46	41
72d Tr Bn									2	75	77	77
2d MI Co									1	25	26	26
TOTALS	250	500	500	390	500	29*	500	500	44*	500	3663	2388

* Officers (ROK)

Incl 1

SECRET

G-2

G-2 SECTION
NARRATIVE SUMMARY
SEPTEMBER 1950

Demands on all of the G-2 subsections were extremely heavy during the first few days of September. Accurate information of the composition of the attacking enemy units, their strength in weapons, the types of weapons used, food, state of morale, depth of reserves, and leadership was crucial to the success of the 2d Infantry Division in its effort to hold its line.

Reports of aerial observers, both those sent out by G-2 on specific intelligence observation missions and the planes spotting for the artillery, were invaluable in the collection of intelligence, having an authenticity and timeliness not possible in any other method of intelligence collection.

Evaluation of all sources of intelligence revealed that the 23d and 9th Infantry Regiments were opposed by reinforced North Korean divisions. The mere weight of numbers was an important factor in the initial enemy successes.

Unfortunately, the need for every available man forced the commitment of the 2d Reconnaissance Company to a defensive area on the division left flank preventing its use as one of the primary intelligence collecting agencies of G-2.

During the first week of September, dissemination of intelligence was greatly hampered by the frequent disruptions in the communications network.

Refugees posed a serious threat to security and screening points were set up to prevent infiltration. Both Korean and American CIC agents were present at these screening centers and forwarded their findings to the division G-2.

To ensure that all sources of information were checked, an intelligence officer questioned the wounded arriving at the clearing station in Miryang.

Close coordination with the Eighth Army G-2 was maintained and, in addition to the daily intelligence reports exchanged, spot reports were submitted to Eighth Army and received by the division G-2 as information of immediate tactical value became available.

Many of the prisoners captured were young, tired, hungry, and discouraged. They claimed that their officers killed them if they showed the slightest inclination to surrender and they also informed their interrogators that they expected the same treatment from the Americans. To counter this mistaken belief, leaflets were prepared urging the North Korean soldiers to kill their officers, abandon their arms, and surrender. The prisoners of war did not seem overly imbued with the communistic spirit and most of them were cooperative and cheerful when they discovered that they were not going to be tortured or killed.

Reports of interrogators and aerial observers indicated by September 5 that the enemy force had lost its punch and that the division would be successful in holding action.

By the 15th of September, the 2d Division intelligence sources had identified all of the major units of the enemy force.

The enemy unit which had launched the heaviest attack on the 2d Division line was, by coincidence, the enemy 2d Division. This unit was almost completely destroyed in the fighting the first two weeks in September.

Fighting from the 22d until the end of September was confined to pursuit actions and the elimination of isolated pockets of resistance. Emphasis of the G-2 Section during this period was concentrated on captured enemy materiel and documents and a screening of civilians in the cities occupied along the route of advance.

In compliance with Department of Army directives, Russian equipment and written instructional material were collected for subsequent return to the zone of the interior.

With organized resistance broken, many enemy soldiers attempted to avoid capture by discarding their arms and moving northward singly or in small groups. Detection of these units was usually a result of the disclosures made by South Korean civilians.

As many members of the North Korean Army had been South Korean conscriptees who served through fear and a desire to be on the winning side, the enemy's strength melted once it became obvious that the UN Forces were going to be successful in their drive.

Fred J. Meyer
FRED J. MEYER
Captain Inf

G-2 SECTION
NARRATIVE SUMMARY
OCTOBER 1950

SECRET

Aerial photo coverage which had been bad in August and September, did not improve. It took from six days to as much as three weeks for higher headquarters to fill photo requests and then the photos forwarded were often copies of photo-maps made during aerial surveys of the period 1946-1948. The best results were obtained, in so far as the Division G-2 was concerned, by utilizing organic Signal photographers to take photos from small liaison planes. These shots were processed and the finished prints were delivered for photo interpretation within 12 to 24 hours after the pictures were taken.

Interrogation of prisoners of war did not elicit the fund of information which the intelligence personnel had become accustomed to during the interrogations of Germans and Japanese during World War II. It was felt that this was not a result of inferior methods of interrogation but of a deliberate plan of the North Korean Command to keep the troops and small unit commanders uninformed of the overall military picture. Another reason for the failure to obtain much valuable intelligence information from the PWs was the low rank of PWs. Undoubtedly, the North Korean officers were highly successful in their attempts to infiltrate the American lines and return to North Korea after the collapse of their forces south of Seoul.

Korean civilians told the advancing Americans that the

air drop of propaganda leaflets would have been far more successful had it been done at night. As people were afraid of the severe punishment (often death) inflicted on anyone found reading or possessing the leaflets, most of those dropped during the day were left alone until collected and destroyed by the military.

As many members of the North Korean Army had been South Korean conscriptees who served through fear and a desire to be on the winning side, the enemy strength melted once it became obvious that the UN Forces were going to be successful in their drive.

With the collapse of the North Korean units, the Communist leaders began to work every angle to further their ends. One extreme example of the extent of their activities was the organization of a female guerilla group which was given the mission of distributing poisoned fruit to the UN soldiers. Although this program was not successful, the activities of Korean prostitutes did impair the efficiency of many United Nations troops.

On 16 October, a task force was organized under command of Lieutenant Colonel Ralph L. Foster, Division 4-2, which had been designated "Task Force Indianhead". It was assigned the mission of entering Pyongyang with assault forces for the purpose of collecting documents and other information of intelligence value (including government records, scientific papers, and evidences of the compulsive influence of foreign powers on

North Korean policies) which might otherwise be lost or destroyed. The task force consisted of Company K, 38th Infantry, the 1st Platoon of the 2d Reconnaissance Company, a composite platoon of the 72d Tank Battalion (five M-26 tanks, one M4A3E5 tank, one half-track reconnaissance car, and seven 2 1/2 ton trucks), an Engineer Demolitions squad, a section of the 82d AAA Battalion, a medical section, the 2d CIC Detachment (-), and representatives of Eighth Army and General Headquarters intelligence specialist teams. The task force was completely motorized.

This task force assembled on the morning of 17 October and commenced its movement north in three serials. By 19 October, the task force had entered Pyongyang and was beginning to transmit coded messages on its findings. It was, however, unable to cross the Taedong River until the following morning when a small group preceded the ROK soldiers in the assault boat crossing. Later, the one-quarter ton vehicles crossed at a railroad bridge while the tanks found a passable crossing at a point up the river. By nightfall, the task force was in possession of two Communist radio stations.

There was no opposition, and the personnel of Task Force Indianhead were able to concentrate on the collection and recording of material. By the 25th of October, with all of its activities completed, the task force was dissolved and its component units were returned to their parent organizations.

The people of Pyongyang evacuated the city during the period of hostilities but soon returned and appeared friendly.

Many citizens of Pyongyang and surrounding towns and cities professed their hatred of the communist regime of North Korea and Republic of Korea and United Nations flags were a common sight before the homes of those North Koreans who appeared to be in sympathy with the United Nations aims.

By the middle of October, the G-2 began getting many reports that the Communist regime in China was holding high level conferences on the advisability of giving active ground support to the North Koreans. Authoritative Chinese radio commentators also disclosed the threats of high ranking Communists to intervene should the United Nations Forces cross the 38th parallel.

There were many evidences of airfield construction throughout North Korea, certain indication that they expected outside aid as their own air force was almost completely destroyed.

North Korean leaders, having nothing to gain personally from a capitulation had at this time undoubtedly decided to continue resistance although this might entail setting up a government in exile in Manchuria. MacArthur's surrender demand was met by the publication of a new North Korean slogan, "Fight to the Death".

The possibility of Communist intervention was discussed in the 2d Division Periodic Intelligence Report of 31 October. The G-2 had learned through his intelligence sources that the Chinese had 316,000 troops massed on the border at that time organized into 44 Divisions constituting 12 armies.

Although this force posed a grave threat to the attacking United Nations divisions, it was felt that the Communists would not attack pending the outcome of their attempt to secure a seat in the United Nations.

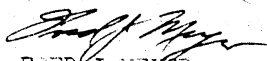

FRED J MEYER
Captain Inf

G-3

HEADQUARTERS SECOND INFANTRY DIVISION
APO 248 U.S. Army

5 November 1950

SUBJECT: G-3 Section History for 1-30 September 1950
TO: Commanding General, Second Infantry Division
(Attn Division Historian)

SEPTEMBER 1950

As the information began to come in from the regiments, the extent of the enemy attack, launched approximately at 010000Z Aug gradually became known. However, due to the uncertainty of the situation, G-3 called off "Operation Manchu". G-3 also alerted for possible movement the 2nd Engr C Bn (-), 72nd Tk Bn (-) and 2nd Recon Co at 010100 Sep.

Contact was maintained with the divisions on the right and left by phone and information was gained of a penetration of about 2000 yards in the 25th Div sector, on the Div left flank. The 2nd Recon Co from their positions on the Div left flank was ordered to report to C.O. 9th Inf for operational control and the 72nd Tk Bn (-) was ordered to move a company down to the 9th Inf in order to give them a reserve element and additional firepower to use on the left flank.

By daylight it was apparent that the 2nd Engr C Bn (-) would have to be used as reserve for the 9th Inf

so they were ordered to report to the 9th Inf in the vicinity of Yongsan.

In the 23rd Inf sector, the situation was such that they had no front. The enemy were behind their front lines and there were companies surrounded. E Co which had been in reserve for the 9th Inf was released back to the 23d Inf at 010810.

The 3rd Bn 38th Inf was sent to assist the 23rd Inf in keeping in the MSR open along the Yongsan-Changnyong road to hold the town of Changnyong the hub of the Div MSR.

EUSAK notified G-3 that the 27th British Brigade Inf had been alerted for possible employment in the Div sector in case the situation became worse.

The deepest penetration reported during 01 Sep was from the 23rd Inf who reported at 011150 that a wedge was driven in to the sector on the boundary of the 9th Inf and the 23rd Inf extending back into our lines 10,000 yards-between grid lines 1398.0-1303.0 with the largest concentration along line 1142 between 1398-1402 estimated at one enemy division in the zone.

Due to the confused situation in the 9th Inf sector very little information came in from them until midafternoon. The 3rd Bn 38th Inf was halted by a roadblock temporarily 5000 yards north of Sibi-ri on the Div MSR.

In the afternoon, the 23rd Inf reported their positions as 1st Bn (G Co attached less C Co) at 1142.0-1402.8 to 1140.3-1401.0. F Co was on high ground at 1143.7-1398.4 and 1144.5-1395.2 with E Co at 1145.0-1401.8.

In the afternoon, G-3 was notified that the 1st Provisional Marine Brigade was ordered, HUSAK, to move to Miryang for possible employment in the Div sector (J-106 01 Sep).

By 011540 both regiments were attempting to establish positions west of the north-south line 1144. The situation in the 3rd Inf sector was such that it became necessary to make several airdrops of ammunition, rations and water to units which were still surrounded.

Heavy casualties were sustained by all units and they were badly disorganized as a result of their positions being overrun by overwhelming masses of troops. By this time, the close of 01 Sep, all the Div reserve had been committed including all available service and technical troops. The units were ordered to regroup, reorganize and hold their present positions and defense line.

Early in the morning of 02 Sep, the 9th Inf reported their locations as 1st Bn at 1155-1285; and an 1155-1588 and the 7th Bn at (-) at 1155-1588.

By 020830, the G-3 had received information from AFM that they were moving 1 reinforced bn of the 1st Marines at daylight to the vicinity of Nonam and that the remainder of the Brigade would follow. The 1st Marine Prov Brig would be attached to the 2nd Div and they would be retained intact to make a certain type attack in conjunction with the 2nd Div and that the 1st Marines would be released by the Div as soon as the mission was accomplished. (J-75 02 Sep).

As a result of the day's attacks to restore positions by the 23rd Inf and 38th Inf, heavy resistance was encountered and very little ground was gained by the end of the day.

Also during 02 Sep, the Div had 51 sorties flown by the Air Force in close support and the Div was assured by JOC that it would continue to receive air priority the following day. These targets taken under fire by the Air Force were controlled by "Mosquito" rather than by the TACs with the regiments due to the many targets available.

During the night of 02 Sep, a number of roadblocks and ambushes were set up by the enemy along the north-south MSR.

An operation order (Op O 73 02 Sep) was issued late 02 Sep by G-3 ordering the 1st Marines to attack through the 9th Inf to the west and the 9th upon being passed through would attack to the northwest and then west to contact the 23rd Inf and attempt to close the gap between the two regiments. The attacks were to restore positions along the Namton River. The 23rd Inf and 38th Inf were to hold their present positions and secure Chanyon. The 7th Bn (-) was placed under the control of Brig Gen Bradley with the 4th Bn (-) attached to protect the left flank of the 1st Marines.

Task Force Bradley, commanded by the Assistant Division Commander Brig Gen Bradley, consisted of 3 North and

South Force made up of all the units south of the point of Greatest penetration between the 9th and 23rd Inf. The North Force was composed of: 9th Inf(-); TACP Bertha 14; B Co 72nd Tr Bn; D Btry(-) 82nd AAA; while the South Force was made up of 72nd Tr Bn (-); 2nd Engr C Bn (-); 1st Bn 9th Inf and two sections of D Btry 82nd AAA Bn.

Due to the fact that some of the ground over which the 1st Marines were to pass to reach the LD was lost during the night, the Marine attack was delayed several hours. However, by mid-morning the attack had jumped off and by 04100 they had advanced 3000 yards against heavy resistance with the aid of very close-in air support furnished by the Marine Corps planes. The Marines tied in with the units on the right and left and were consolidating their positions by nightfall. G-3 ordered the Marines to be prepared to continue the attack at 0400. The 1st Marine locations were reported to be: 1st Bn 1st M R 41.0-9.0; 2nd Bn 5th M R 49.7-9.8; 3rd Bn 5th M R 44.0-9.8. The Marine CF was superimposed upon the 9th Inf C.

As a counterpart of Gen. Kelly's Force, the units north of the penetration were formed under the control and command of Brig. Gen. Hayes, Division Artillery Commander, and it consisted of: H and K Btry, and Div Arty; 3rd Inf (-); 1st Inf; 57th FA Bn and 1st FA Bn. The Div Arty units continued to provide close ground support during this period along with the AAA units.

The task organization of the 1st Marine Provisional

Brigade was as follows: Hq and Sv Bn; 5th Mar Bn reinforced; 1st Bn 11th Mar; Co A 1st Engr Bn; Co 1st Shore Bn and detachment of Recon Company. ~~SECRET~~

The 1st Mar Brigade jumped off at 040800 in a continuation of the attack with the 3rd Bn passing through the 2nd Bn and advances of 3000 to 4000 yards were made against light opposition during the day. Meanwhile, Task Force Bradley Forces also attacked and were up to Phase Line #1 by evening encountering but slight opposition.

Task Force Maynes continued on their mission of securing and clearing Chanmyon, to insure the uninterrupted use of the northern MCR. The Task Force consolidated positions along Phase Line #1 also in preparation for a coordinated attack west with adjacent units. The enemy continued to probe and make small-scale attacks all of which were repulsed.

During the afternoon of 04 Sep, both the 9th and 1st Marines observed enemy withdrawal in groups of 300 to 400 along their front.

By darkness the 9th Marines had gained its objective and all the 9th Inf. The location of the 1st Inf brig was given as 1st Bn 5th Mar 44.7-45.3 to 44.7-45.7; 3rd Bn 5th Mar 45.7-46.3 to 47.4-48.0; 4th and 5th Bns 49.0-49.7 to 49.5-49.1.

During the early morning of 05 Sep, both the 43rd Inf and units of the 9th Inf were reported to be under heavy attack but holding their positions. It was necessary though, in the 9th Inf in maintaining their position to send the 1st Bn 9th Inf to assist Co C 9th Inf against their attack.

The Marines jumped off on schedule and proceeded to move up to and secure Phase Line #2 against little resistance on 05 Sep. The 5th Inf striking on the right flank of the 1st Marines, with the 3rd Bn 3rd Inf attached, successfully counterattacked and disrupted the reorganization of the enemy and advanced to Phase Line #3 but were withdrawn under cover of darkness to ground more fully defended along Phase Line #1.

The 1st Marines were ordered relieved of attachment to the 1st Div USMC effectively 060400 and stated that sometime during the day of 05 Sep, the 3rd Bn 3rd Inf would return to Div control (3-1 0601). Following the attack during 05 Sep, the Div was further organized and defend with units currently available on the coast of the 1st Div at the time of the relief. The Div was further notified by USMC that the only personnel available to the Div would be those from their own resources.

Instructions directive was issued by 3-2 directing the attachment of 3rd Bn 3rd Inf to the 1st Div (3-1 0601 0601). This was a general order long and detailed with instructions on 1st Bn 3rd Inf position during 0601 0601.

USMC also gave the Div the mission of protection, the 1st Bn 3rd Inf, in the Div's left rear, which was the mission of the 4th Div.

In compliance with the orders received from USMC,

G-3 issued an operations order (Op O #4 032400, Sep) directing the Div to reorganize on Phase Line #1 and be prepared to attack on order. The 23rd Inf was ordered to organize on Phase Line #1 with two Bns on line and be prepared to attack on order. The 5th Inf was also ordered to organize on Phase Line #1 with two Bns on line and one in reserve and be prepared to attack on order. The 9th Inf was ordered to organize on Phase Line #1 with three Bns on line and one in reserve and be prepared to attack on order. The 2nd Recon Co was to continue screening the Div's left flank while the 7th Inf (-) was in Div reserve.

The relief of the 1st Bn by the 3rd and 5th Inf was completed at 0600H and AUSA was notified at 0630H as accomplished.

Based on the information from the 5th and 3rd Inf, that the enemy seemed to be withdrawing, the 2nd Recon Co was to maintain contact with the enemy by patrol activity.

During the day, the 2nd Recon Co was to maintain contact with the enemy by patrol activity.

The 3rd Inf of CG 31 continued its operations and continued to block the enemy from Hill 25. The 3rd Inf captured high ground in its sector and re-consolidated their position with the close of the day. The 9th Inf with its 2nd Bn on the line, and the 5th Inf on the left flank; 1st Bn 9th Inf in reserve on Phase Line #1.

The weather closed in during the hours of darkness bringing rain and limiting the air support to mid-day sorties and also restricting observation of enemy artillery positions by the Div Lt aircraft.

In an exchange of information between the Div and the 8th Div early CF Day, 4-3 received information that the right flank of the 8th Div was receiving the heaviest mortar and artillery they had yet received. The 9th Inf also reported heavy concentrations during the early hours. This was followed in the 9th Inf sector by an attack on their OSLR at 07000 which forced the companies to withdraw to positions on the M.L.R.

Div Lt units 7 and 11 both reported that they had discovered the road between Kham and Khampong and were ordered to send troops up there to clear the mine.

At 07100, a letter of instruction was sent to the 9th Inf from G-3 directing the plan of defense for the defense of the southern M.R. The plans were to include an orderly delaying action from the present M.R. to the FDL. This plan was given the code designation of "Lisou" and the 9th Inf would have the following units under their command: 9th Inf (-); 1st and 2nd Inf; and 3rd and 4th (-); 7th and 8th (-); Battery D and M.L.R.; 15th and 16th (-); 17th and 18th (-); and 19th and 20th (-). This plan also contained the operation of the M.R. directly under

Div control and would have them execute a delaying action along the Div south flank by mining and fighting.

At 070115, Div received information from USAA that the relief of 3rd and 9th Inf was not considered feasible at the present time but that it would be accomplished at the earliest date practicable.

Shortly before midnight the enemy were again reported in Mongson and the 9th Inf sent a shielded jeep and half-track into the town to clear it out and keep the MSR open.

The operations planned for the period of 08 to 15 Sep were consolidation of present positions and the continuation of aggressive patrolling. This was a period of build-up, reorganization of units and preparation for the coming offensive.

All three of the Regiments received attacks from 0800 to 0200 hours during the night and day of 08 Sep but they were repulsed with no ground lost. In the 3rd Inf sector particularly the lines continued to be very tight but there were no reports of penetrations during the day.

The air support was restricted during 08 Sep due to bad weather including rain in the Div sector.

On 09 Sep, it was noted that the Div front line withdrew from 40 miles on 1 Aug to 30 miles on 09 Sep. During the day of 09 Sep, the Regiments continued to improve their positions and the 3rd Inf repulsed small-scale probing attacks. Task Force Haynes used one company from the reserve bn with 1st

units to clean out the town of Changnyong.

On Operations Directive ~~issued~~ at 091000 directed the Div Res Bn, and Bn 38th Inf, to be assembled and move to the vicinity of the old Div Arty CP between the east-west coordinates (91.0-93.0) along the north-south MSR with the mission of insuring the uninterrupted use of the MSR and to mop up the rear areas.

The weather continued bad with rain thus hampering effective air support.

Continuation of aggressive patrolling and improvement of front line positions by laying minefields and barbed wire was the order of the Day for all front line units on 10 Sep. During the period of 10 Sep there was little enemy activity reported during the day or night. Div Arty Lt ~~44/4 44~~ ~~airfield~~ received a small-scale attack during the early hours and lost one plane when a bomb fragment was thrown into it.

Physical contact was made with 1 Co 78th Inf on the Div left flank at 14300 by ~~the~~ ^{5th} ~~unit~~ ~~in~~ ~~the~~ ~~area~~ at the coordinates 41. - 04.

The situation in the 3rd Inf sector was inconclusive but improved somewhat during the day. In the 5th Inf sector a build-up toward Hill 409 on the Div right flank was noted.

The 3rd Inf and 5th Inf received sporadic fires and small scale attacks during the early hours of 11 Sep with no ground lost. The enemy was kept under constant pressure in these sectors by the excellent coordination of ground forces

air and artillery fire as targets were plentiful. The air supported the ground forces with 67 sorties flown on Sep 11 with most of them in front of the 33rd Inf where an estimated 1500 enemy were casualties at 40-95. Another 1500 were reported to have been killed at 40-94.

Operation "Snake-Flush", designed to flush out the enemy east of the MSR between Hongsan and Chongnyong had as its organization: one section of 81mm mortars, one M19 AAA, six MPs and two squads of soldiers from the 9th Inf. Light resistance was encountered by the patrol in the vicinity of 114-119.

Div G-1 sent a check point reference overlay to all units (J-47, 110930 Sep) to use in reporting enemy positions, friendly position, calls for artillery fire and calls for air strikes.

All units were to be in a state of alert to detect the enemy defensive positions and in keeping up of the enemy in the rear area during the day of 10 Sep. Little enemy activity was reported by the regiment. However, in front of the 33rd Inf, drums and the voice of women in the area was heard in an attempt to bolster the morale of the enemy apparently.

At 121800 command from USMA placed their Operations Plan #10 in effect as an order effective 121000 (J-47 121000 Sep). The tentative start date was set by USMA for this operation on 10 Sep and 12-hour time to be

announced later.

On 130913, an Operations Directive was sent to Task Force Haynes and the 9th Inf directing they initiate immediate aggressive patrolling within their sectors of responsibility with the mission of determining enemy strength, location, state of organization or disorganization, roads and bridges and any bridges across the Nam-tong River. This had previously been ordered by USMACV.

LT Colonel W. R. ... visited the Div CP at 131100. Later a meeting of the Commanding Officers of the 9th Inf, 8th Inf, 10th Inf, and Div Artillery was called at the Div CP concerning the immediate operation of the 13th of May.

At 131200, 1-3 received word from the 4th Div that the 9th Inf had been relieved today and would notify the Div as to the situation.

During 14 May there was considerable patrolling by the remnants in an effort to locate the enemy positions and they also improved their position by advancing to higher ground. In the 9th Inf, they occupied Hill 1 (1144.1-1145.1) and moved toward Hill 01 but the strong opposition there and pulling back to prepared positions. The 9th Inf reported that Hill 01 (44.4-91.2) was strong enough to be an objective. anti-flush also went out again with the companies to the same area as the previous day and encountered enemy resistance and forced the anti-flush to retreat.

Hill 185 was given to the 23rd Inf to occupy as a result of the opposition encountered by the 9th Inf on Hill 201.

Operation Order #5 141800, 2nd Div, was issued giving the following information: 8th Army was to attack from the 2nd Div area with the 3rd and 9th Inf in USMC Reserve in the vicinity of Samnanjin. D-Day was set up as 15 Sep and the 2nd Div was to attack from its positions with the 1st and 2nd Inf on the front line positions. It further stated that the 9th Inf would attack and capture Hill 201 by 151400 and support the advance from that position on D-Day. The 3rd Inf and 4th Inf would attack in their zones and the 2nd Inf would return to their positions from the 9th Inf. The Division Security Force under Major Jack Houn was given the responsibility of securing the town of Ch. Anhyon. The 2nd and 3rd Inf (-) would be Div reserve in the vicinity of Samnanjin.

During the 15 Sep, three positions consolidated their positions and continued to hold with only a few small-scale attacks on the 2nd Div positions. However, Div Artillery reported that there appeared to be a buildup opposite the 3rd and 4th Inf.

At 1100 hours returned the 3rd and 4th Inf and 2nd Div under Div control and dissolved the Security Force. The 3rd and 4th Inf remained under the control of the 23rd Inf by 1700 (3-4-15) (15 Sep 1950).

During 15 Sep the artillery fired observed missions employing both ground and air observation, and harassing and interdiction missions. The 2nd AA Bn continued to provide ground security for the infantry and artillery units.

All units were ordered to display orange panels on all front line tactical vehicles in order for air support planes to distinguish friendly from enemy vehicles.

On 15 Sep, the 5th Inf jumped off in their attack with the 1st Bn on the left and the 2nd Bn on the right to attempt to seize Hill 402 with two companies. After reaching within 500 yards of the top, they were forced to withdraw. Though the attack was supported by air and artillery fire on the hill, the jump-off on the attack was delayed because of a delay in the arrival of air support due to bad weather in the area.

The 2nd Bn, with the 1st Bn on the left and the 2nd Bn on the right moved out toward Objective 1 at 0700. They encountered heavy resistance. Initially they were unable to proceed against light resistance. After overrunning it, on the left the 1st Bn was forced to withdraw. The 2nd Bn was able to reach Objective 1 and hold it. The 1st Bn was ordered to withdraw.

The 1st Bn, with the 2nd Bn on the right, the 1st Bn on the left and the 2nd Bn in reserve, jumped off in their attack toward Objective 2 at 0700. They proceeded to the objective and held it until the end of the day.

The 3rd Bn 9th Inf arrived at the 9th Inf CP at 161500 but in compliance with EUSAK orders, the 9th Inf would have to replace the 3rd Bn in EUSAK Reserve with another Bn from the 9th Inf. The Tank Company of the 9th Inf was to remain in Army Reserve.

The G-3 informed EUSAK at 170400 that the 9th Inf had to withdraw two of their companies from Hill 901 to their original positions. The G-3 also ordered the 9th Inf to reorganize and plan an attack Hill 901 upon Div order.

Also on 17 Sep, the 2nd Bn and 3rd Bn (-) were directed to reposition and select a bridge site in each of the 3rd, 4th, 5th and 6th Inf sectors. The 3rd Inf and 4th Inf were ordered to send a patrol west of the 2nd along the river at the earliest on 17 Sep and be prepared to cross the river on Div order.

The 3rd Inf consolidated its position on the river and organized its defensive lines. The regiment also carried out strikes along the Junction River with good results.

The 4th Inf Regimental CP moved from Hill 91 (1146.3-140.0) and established a new CP (1141.1-140.0).

Division Artillery units fired on targets of opportunity in the battle area. The Div units also conducted operations along the Junction River. They continued to harass the enemy on both the east and west sides of the river. The 1st Bn in support of the 9th Inf in the attack on Hill 901.

The G-3 reported to EUSAK at 170640 that the 3rd Bn 9th

Inf had relieved the 2nd Bn of the 23rd Inf on the night of 16 Sep.

The Commanding General directed at 171415 that the 9th Inf consolidate after capture of Hill 201, fill in gaps big in deep, arrange for defensive artillery fires for the night and to make preparations for tomorrow.

G-3 ordered the 23rd Inf and 25th Inf to select and secure a crossing site and make a bridghead opposite their sites by 18100. The 23rd were also directed to reconnoiter and select aid sites in each company by 18 Sep.

*M 4
/ 11*

By 181055 the 23rd Inf had reported that two squads of the 1st Bn crossed the Nhaton River and by 1800 hours, the 23rd Inf had two companies land their vehicles across the river in their zone.

The 2nd Bn 9th Inf attacked Hill 201 (11414-1800.0) at 180600 following a 15 min mortar artillery preparation. The attack was met by heavy enemy resistance conducted from skillfully constructed and selected enemy positions. Hill 201 was still held by the enemy at the close of the period.

The 1st Bn 9th Inf received heavy mortar fire on the night flank in their zone accompanied by continuous mortar fire. All other elements were held.

The 1st Div G moved on 19 Sep and entered Cham - (11414-1800.0) at 190000 Sep.

The 2nd Bn 9th Inf reported from the 1st Div zone of action to revert to AFAC Reserve in the vicinity of

Sammanjin. This Bn replaced the 3rd Bn 9th Inf which had been returned to the 9th Inf.

The 1st Bn 308th Inf reverted to Div for operational, logistical and direct control as ordered by G-3.

Hill 01 was captured by 3rd Bn 9th Inf on 19 Oct and they reorganized and continued the attack to the south to positions at 114,0-13,0. In the 3rd Inf sector, the 2nd Bn captured Hill 17 on 19 Oct and the 1st Bn recaptured the 308th Infantry in the vicinity of Hill 01 by placing effective fire on the reverse slopes of the position.

As a result of the 3rd Inf sector, the 3rd Bn had pushed the attack and the command of the 3rd Bn across the river and had secured Hill 01 by 19 Oct.

During the early hours of the morning of 20 Sep, it became apparent that the Div had successfully captured the enemy's line and could continue to advance. The 3rd Bn moved to the river and captured Hill 01 on 20 Sep. The 3rd Bn moved from positions held on previous days successfully captured Hill 01 and Hill 02. The 1st Bn captured Hill 03 and Hill 04. The 2nd Bn captured Hill 05 and Hill 06. The 3rd Bn captured Hill 07 and Hill 08. The 4th Bn captured Hill 09 and Hill 10. The 5th Bn captured Hill 11 and Hill 12. The 6th Bn captured Hill 13 and Hill 14. The 7th Bn captured Hill 15 and Hill 16. The 8th Bn captured Hill 17 and Hill 18. The 9th Bn captured Hill 19 and Hill 20. The 10th Bn captured Hill 21 and Hill 22. The 11th Bn captured Hill 23 and Hill 24. The 12th Bn captured Hill 25 and Hill 26. The 13th Bn captured Hill 27 and Hill 28. The 14th Bn captured Hill 29 and Hill 30. The 15th Bn captured Hill 31 and Hill 32. The 16th Bn captured Hill 33 and Hill 34. The 17th Bn captured Hill 35 and Hill 36. The 18th Bn captured Hill 37 and Hill 38. The 19th Bn captured Hill 39 and Hill 40. The 20th Bn captured Hill 41 and Hill 42. The 21st Bn captured Hill 43 and Hill 44. The 22nd Bn captured Hill 45 and Hill 46. The 23rd Bn captured Hill 47 and Hill 48. The 24th Bn captured Hill 49 and Hill 50. The 25th Bn captured Hill 51 and Hill 52. The 26th Bn captured Hill 53 and Hill 54. The 27th Bn captured Hill 55 and Hill 56. The 28th Bn captured Hill 57 and Hill 58. The 29th Bn captured Hill 59 and Hill 60. The 30th Bn captured Hill 61 and Hill 62. The 31st Bn captured Hill 63 and Hill 64. The 32nd Bn captured Hill 65 and Hill 66. The 33rd Bn captured Hill 67 and Hill 68. The 34th Bn captured Hill 69 and Hill 70. The 35th Bn captured Hill 71 and Hill 72. The 36th Bn captured Hill 73 and Hill 74. The 37th Bn captured Hill 75 and Hill 76. The 38th Bn captured Hill 77 and Hill 78. The 39th Bn captured Hill 79 and Hill 80. The 40th Bn captured Hill 81 and Hill 82. The 41st Bn captured Hill 83 and Hill 84. The 42nd Bn captured Hill 85 and Hill 86. The 43rd Bn captured Hill 87 and Hill 88. The 44th Bn captured Hill 89 and Hill 90. The 45th Bn captured Hill 91 and Hill 92. The 46th Bn captured Hill 93 and Hill 94. The 47th Bn captured Hill 95 and Hill 96. The 48th Bn captured Hill 97 and Hill 98. The 49th Bn captured Hill 99 and Hill 100.

During the early morning hours of 20 Sep, the 3rd Bn and the 4th Bn completely reestablished the con... of the 3rd Bn. The 1st Bn crossed the river... under a... of fire... The 2nd Bn, the 3rd Bn, the 4th Bn, the 5th Bn, the 6th Bn, the 7th Bn, the 8th Bn, the 9th Bn, the 10th Bn, the 11th Bn, the 12th Bn, the 13th Bn, the 14th Bn, the 15th Bn, the 16th Bn, the 17th Bn, the 18th Bn, the 19th Bn, the 20th Bn, the 21st Bn, the 22nd Bn, the 23rd Bn, the 24th Bn, the 25th Bn, the 26th Bn, the 27th Bn, the 28th Bn, the 29th Bn, the 30th Bn, the 31st Bn, the 32nd Bn, the 33rd Bn, the 34th Bn, the 35th Bn, the 36th Bn, the 37th Bn, the 38th Bn, the 39th Bn, the 40th Bn, the 41st Bn, the 42nd Bn, the 43rd Bn, the 44th Bn, the 45th Bn, the 46th Bn, the 47th Bn, the 48th Bn, the 49th Bn, the 50th Bn, the 51st Bn, the 52nd Bn, the 53rd Bn, the 54th Bn, the 55th Bn, the 56th Bn, the 57th Bn, the 58th Bn, the 59th Bn, the 60th Bn, the 61st Bn, the 62nd Bn, the 63rd Bn, the 64th Bn, the 65th Bn, the 66th Bn, the 67th Bn, the 68th Bn, the 69th Bn, the 70th Bn, the 71st Bn, the 72nd Bn, the 73rd Bn, the 74th Bn, the 75th Bn, the 76th Bn, the 77th Bn, the 78th Bn, the 79th Bn, the 80th Bn, the 81st Bn, the 82nd Bn, the 83rd Bn, the 84th Bn, the 85th Bn, the 86th Bn, the 87th Bn, the 88th Bn, the 89th Bn, the 90th Bn, the 91st Bn, the 92nd Bn, the 93rd Bn, the 94th Bn, the 95th Bn, the 96th Bn, the 97th Bn, the 98th Bn, the 99th Bn, the 100th Bn.

river and succeeded in getting the last elements across during darkness 19-20 Sep. The 2nd and 3rd or 30th Inf continued their forward advance and occupied high ground west of the river.

In the air, a total of 35 sorties were flown in the 2nd Div zone including three A-19 attacks. Principal targets included Lyon-pun, Sian-ai and Nye-pen. All of these towns were known to be enemy HQ and were strafed, napalmed and hit with heavy bombs with excellent results.

The Commanding General 1st Army congratulated all units of the 2nd Div on its successful crossing of the Norton River.

At noon, the 2nd or 3rd or 30th Inf attacked south-west and met heavy resistance from Hill 149 (11 P.C.-149.0) 21 Sep. Following a coordinated attack, Hill 149 was taken but the enemy offered stubborn resistance from Hill 148 (11 P.C.-148.0) and Hill 147 (11 P.C.-147.0).

In the 2nd Inf sector, the advance of the 1st or 2nd or 3rd or 30th Inf was checked by a small group of "A-19s" which offered stubborn resistance. The enemy occupied commanding positions that were well supplied with ammunition but did not appear to be well organized.

A total of elements of the 1st or 2nd or 3rd or 30th Inf equipped with 100mm Doves initiated the crossing of the Norton River. Intense small arms and mortar fire were encountered from the west bank of the river. Enemy artillery fire centered

nine of the ten DUKWs non-operational which in turn necessitated the withdrawal of a Co west of the Nakdong River.

The 2nd Amer 3 BN continued its close support of the Regimental Combat Teams. They continuously repaired DUKWs, cleared mine fields, ferried equipment and troops across the Nakdong River, constructed sandbag roadways for the DUKWs and continued work on the pontoon bridge.

On the morning of 11 Sep at 0700 hours, the enemy, estimated at one BN attacked the 1st BN of the 7th Inf and were pushed back from their positions. After receiving reinforcements, the BN secured their northwest flank prior to continued advances. The 1st BN of the 2nd Inf closed on the west side of the Nakdong River at 2100. Other elements of the regiment had captured GIN H-11 by 1600 and dug in defensive positions for the night.

At 2300, elements of the 5th Inf moved into position in the vicinity of their proposed bridge site. They were met by heavy enemy mortar and artillery fire which forced them to withdraw to their positions. All efforts to cross the river were halted and the units were moved back to their original positions.

In the afternoon, a Co, reinforced with tanks, jumped off on 10 Sep for Choryu. Only light enemy resistance was encountered along the route and by 1400 they had entered the town of Choryu.

Other elements of the 7th Inf jumped off at 0910 from Choryu to contact the enemy in determining the enemy

strength and location along the direction of advance. Slight opposition in the form of small arms and some direct fire weapons were encountered by disperses.

Along the 9th Inf sector, the 1st Bn took over the responsibility of the area vicinity Hill 311 (1140.3-1306.6) to the vicinity of Hill 409.9 (1131.5-1307.3). Their mission was to block any eastward movement of the enemy in that vicinity.

At 030530, 3rd Bn 9th Inf moved by water from their position west of the Div Floating bridge. This relief was accomplished and completed by 0444Z.

The 1st Bn 9th Inf continued to block the enemy's movement from Hill 409 and protect the Div right flank.

Elements of the 3rd Bn captured Hill 371 (1131-1307) and secured the Div Objective, vicinity 3100-01 in the left flank area. Slight opposition.

The Div moved progressively out of its bridgehead area, split into the proposed sectors, with the 3rd Inf advancing northeast out of 3100-01 and the 1st Inf fighting on the outskirts of Ayopoko, a village previously driven the enemy from strong hill-top positions west of Jao ye. Meanwhile, the 5th Inf had been given the mission of protecting the flanks of the Div, and she will be in proper position to defend the Div front east of the Haktan River.

The early morning hours of 14 Sep were extremely quiet, but the 3rd Bn was relieved from the 1st Bn and that they

were sending a reinforced company to move southeast out of Sinban-ni to contact elements of the 9th Inf. The attack on Hyopchon from the south by the 3rd Inf and from the northeast by the 5th Inf continued.

At the end of the day, the Div had successfully completed the double envelopment of Hyopchon, and enemy attempts to escape were successfully blocked and straggled there by tactical air supporting the Div.

At 04100, 2-3 issued a special Operational Directive which ordered the 3rd Inf to advance on and secure Kochang, and the 5th Inf to seize Anui. The 9th Inf meanwhile, was ordered to destroy all scattered enemy groups south of Sinban-ni and on Hill 409. The 2nd Bn 9th Inf still contained the enemy vicinity of Hill 409, and the balance of the 9th Inf were ordered to move the 02 to vicinity of Cho ye and on to further Div disposition.

During the day, the 3rd RIF closed into the bivouac area in vicinity of Cho ye, while the 5th Inf moved 30,000 yards on the road toward Kochang, with the 1st Inf in the rear behind the 5th Inf. Heavy resistance throughout the day was all out.

The 1st Inf was unable to find a road leading west out of Hyopchon and it was therefore necessary to have the 2nd Inf follow the 3rd Inf instead on the northern route. The 3rd Inf was ordered to send a rifle company just west of the Haktou River to relieve 1st and 2nd Inf with

the mission of destroying an enemy ammunition dump.

An operational directive was issued to the 2nd Recon Co ordering reconnaissance on the Div south or left flank in the area of Sinban-ni to Tiesan-dong.

Word was received on 27 Sep of the death of 1st Lt Thomas Lombardi, formerly of G-3 Section, who had joined the 38th Inf less than a week ago as a company commander.

On Sep 26, the 38th Inf destroyed the ammunition dump in the vicinity of Lpon-ni. The 38th Inf authorized movement from 2 Chong-ye south to Lpon-ni to destroy the enemy in the zone. The 38th Inf reinforced company, fighting a delaying action.

The 38th Inf on 27 Sep captured Rocking, placing roadblocks to cover all avenues of approach. Over 300 enemy were taken prisoner. In the night, the 38th Inf passed through the 38th Inf at Rocking and captured Lhaul to the south at 1930 hours.

The Div G-2 moved to Hyogechon at 0100. Lt Col Coulter, 38th Corps commander, extended congratulations on the rapid capture of Hyogechon.

At 0100, Lt Col Coulter was able to wire his congratulations also on the capture of Rocking by the 38th Inf.

He ordered the 38th to continue clearing Rocking and await further orders. The 38th Inf (32nd) was attached to the Div and ordered to protect and control the area formerly held by the 38th Div east of the Chong-ye River from

Hill 409 south to the Div ~~1116~~ boundary, relieving the 2nd Bn 9th Inf (J-60 71800).

During 27 Sep, the 1st Bn 9th Inf was given the mission of patrolling and protecting the Div HQ. The 2nd Bn established positions on Hill 409, while the 3rd Bn continued the sit on on long.

The 1st Bn of the 23rd Inf moved north to Horyang, encircling the position of the 1st Bn from the west, withdrawing from Hill 409. The 2nd Bn and 3rd Bn 23rd Inf remained in Anui, patrolling to the east and west.

The 3rd Bn remained in Hockang, patrolling to the north and northwest, planning to move toward on long.

The 1st Bn of the 23rd Inf permitted only 3 sorties by the 1st Bn support on 27 Sep. In Anui, late in the day, a small group of the 1st Bn 23rd Inf found them they would be relieved by the 1st Bn 23rd Inf in the vicinity of Hockang, 1000 m. south of the 1st Bn.

On 28 Sep, elements of the 1st Bn captured 300, which elements of the 2nd Bn captured 100, with the remainder of the 1st Bn remaining in Anui. The 1st Bn advanced approximately 60 miles to capture Chongju - a light operation. The 1st Bn 23rd Inf was reported as relieved by the 1st Bn 23rd Inf. The 1st Bn 23rd Inf left from Hockang at 0800 and arrived in Chongju at 1100.

The Div HQ moved to vicinity of Anui and 1st Bn 23rd Inf 1000.

The 38th Inf reported that they had discovered atrocities by the departing North Koreans in Chonju in which there were approximately 300 dead. The 15th Inf ordered by G-3, (J-63 221300 Sep) sent patrols to the north and prepared to proceed on road to Hanju.

A record number of air sorties (107) in support of the Div attack were flown by Tactical Air during 25 Sep.

The 9th Inf was ordered to protect on 26 Sep, the NAR east of Anui to Hocheon, with aggressive patrolling to destroy organized enemy.

On 27 Sep, the 49th Inf was ordered to take over the protection of the Div NAR from Anui inclusive to Chonju exclusive, patrolling north of Hocheon and patrolling aggressively in the area to destroy organized enemy.

The 21st Inf resumed the attack on 28 Sep toward the objectives of Hoesan and Hanju, and at 1700 were again entering Hoesan with no apparent opposition.

The 7th and 8th Bns were ordered into Div reserve vicinity of Anui. As it was necessary for the 21st Div to use the road to 27 in this area to reach their objective, they were given permission by Div to use the route of the 21st Inf in reaching their objective.

On 29 Sep, the leading elements of the 21st Inf closed into Hanju, while the 49th Inf and the 21st Inf continued on their missions. The 21st Inf reported it met no FOL, and that resistance was light. G-3 reported that 1st Corp and 1st AF

Force representative to Chonju to inspect the airfield for possible use as a C-47 strip. The Div CP moved to Chonju and opened there on 01 Oct.

ROBERT M. SCHWARTZ
Major, GSC
Asst. G-3

Staff Section Report G-3 Section
Second Infantry Division
October 1950

SECRET

G-3 problems during the month of October were minor compared to the heavy demands on the G-3 staff for the previous month. Eighth Army announced that major enemy resistance had ceased on 1 October. On 2 October, the 2d Division was given the mission of completing the destruction of all enemy groups within its zone of action. Republic of Korea National Police took over the control of all cities upon the destruction of the enemy units. Civilians suspected of being deserters from the North Korean forces were picked up and turned over to CIC agents who determined their disposition. Evacuation of North Korean soldiers, which had become a major problem during this period, was handled through the normal Prisoner of War channels. The large quantities of enemy ordnance which had been abandoned were guarded by Korean National Police until ordnance teams could collect them.

The division was directed on 3 October to assemble in the Seoul-Suwon area upon completion of its mop-up mission and go into Eighth Army reserve.

Patrols uncovered much material of intelligence value during the initial mopping-up period. Many enemy casualties were inflicted while losses among 2d Division personnel were extremely light. By the end of the first week and still during

SECRET

week most patrols submitted negative results and, on the 10th of October, the division command post was moved to Yon Dun Po.

SECRET

Upon arrival of the units to the division assembly area, all of the RCPs were broken into their component parts permitting the initiation of a period of reorganization, command inspections, and training.

The training program, which was initiated on 12 Oct addressed the integration and training of South Korean soldiers, small unit critique of past operations, weapons training, convo discipline, and tactical training.

The last elements of the division, including Headquarters 3d Division (Near) did not close into the division area until the evening of 14 October but all initiated the training program as soon as possible after closing. At this time it was believed that the combat operations might be terminated quickly and the 3d Division returned to the zone of the Interior.

On the 10th of October the division began planning for a new mission. The security of the supply line from Pyongyang to Seoul. The directive included the use of RCP which was a major element of the division and assigned to I Corps with the mission of protecting Pyongyang and surrounding Air Field.

There was, however, one highly secret operation carried out by I Corps Intelligence which entered the city of

Pyongyang with attacking elements with the mission of securing any material of intelligence value. The task force was highly successful in this mission.

The 23d RCT began its relief of elements of the 24th Division in the Haeju-Chaeryong-Sariwon area on the 21st of October in compliance with the new operational instructions regarding the assumption of responsibility for the Pyongyang-Seoul route of supply.

The 2d Reconnaissance Company moved forward on the 22d closing on Sariwon by early afternoon. All units with the exception of the 38th Infantry and the Division Artillery Headquarters had completed their displacements forward by the end of the period.

ROBERT M. SCHWARTZ
Major, GSC
Asst. G-3

Avn Sect

ARMY AVIATION SECTION
HEADQUARTERS COMPANY
2ND INFANTRY DIVISION
A.P.O. 248 c/o P.M.
SAN FRANCISCO, CALIFORNIA

September 1950

SECRET

The first day of this month started one of the most hectic periods the section had ever gone through. The night of 31 August and early morning of 1 September marked a heavy offensive on the part of the North Koreans. They crossed the Naktong River and cut off large bodies of friendly troops. The section had flown several platoon leaders and Company Commanders from the 9th RCT for a reconnaissance. A reconnaissance in force had been planned for the morning of 1 September. Instead of furnishing aerial cover for this force, we sent out observers every hour to observe the enemy situation and to try to locate our own front lines.

At about 0930 on 1 September the section got a call that several groups of friendly troops were cut off and we were requested to drop supplies to them. During the rest of the day fourteen (14) drop missions were flown, in which a total of approximately 2000 pounds of food, water medical supplies, and ammunition were dropped. During the period of 1-4 September twenty seven (27) drops were made. The pilots participating in this were Capt. Wilbert L. Armstrong, Capt. George H. Lawrence, 1st Lt. Wilford A. Baugh Jr., 1st Lt. Ralph L. Marohn, 1st Lt. John W. Roush, and 1st Lt. Barton F. Richards. Several of the mechanics also participated in these missions, dropping the supplies from the rear seat. These were Cpl. Charles W. Cathcart, Cpl. Donald J. Brosnahan, Cpl. William J. Zadai, Cpl. Roger N. Raaen, and Sgt. Elvage Holland. Cpl. John P. Thompson supervised distribution and loading of supplies. The performance of the planes was phenomenal in that with the pilot, mechanic, and load of supplies, they were greatly overloaded.

On 2 September 1st Lt. Thomas K. Ryan relieved 1st Lt. John W. Roush at Pohang and took Cpl. Oscar E. Hightower with him. 1st Lt. Wilford A. Baugh Jr. had returned from D.S. with the 15th FA. Bn. on 31 August.

On 4 September Capt. Armstrong and Lt. Baugh flew the first Horsefly mission in the L-17 which consisted of leading Air Force fighters in close support of the ground troops.

On 15 September the section moved from Miryang to Maun-ni. A strip had been prepared by the 2nd Engineer for us right by the C.P. After the Division C.P. moved out the Division Band was attached to us as a security force under the command of 1st Lt. Fred M. Petersen. Also while at this location, we acquired another plane, an L-5, and a pilot, Lt. Norman Olson.

On 20 September the section moved to Changyong where we had the best quarters of the entire war. Our strip was along side a group of school buildings in which we set up barracks, mess hall, and operations. On the same date we shipped one of our L-16s to the 89th tank Bn.

On 22 September Capt. Lawrence was placed on D.S. to work with a Bn Combat Team in the vicinity of Hill 409. On the same date the L-17 was taken to Pusan to the 47th CLAM Co. for repairs and was never returned to us. About this same time the L-5 was doing double duty as Horsefly and aerial ambulance for evacuation of badly wounded patients.

On 25 September Lt. Olson and Sgt. Bruce D. Reiser were transferred to IX Corps to form an Air Section there.

On 26 September the section moved to a strip on the Naktong River. No one who spent the night there will ever forget it because the stench from dead North Korean soldiers in the area was overpowering.

On 27 September the section moved to a strip at Hyopchon. This was a very poor strip in that it was built on soft sand. This made it very difficult for take off and taxiing and extreme caution had to be used in landing.

28 September marked the move to Kochang where we had a fine strip on top of a plateau.

On the evening of 30 September the section moved to Chonju. We were delayed by the road being torn up and blocked by a disabled tank. It was 2215 hours before the convoy was able to move again. About five miles past Anui the column came upon a patrol from the 23rd Infantry which was engaged in a fire fight with a force of 13 North Koreans. The convoy was escorted past the scene of the fight by the patrol which had a K-16 with them. The convoy proceeded the rest of the way to Chonju blacked out. This wasn't too bad since it was bright moon light. The section arrived in Chonju at 0815 on 1 October.

The flights at the end of this period are as follows:

FLIGHTS BY TYPE	NUMBER FLIGHTS
C-3	27
C-4	7
C-21	300
C-27	117
C-28	4
TOTAL 455	

1st Lt. T.K. Ryan, flew 25 missions at Pohang dong before being relieved by Lt. B.F. Richards, who flew 7 missions before returning to Miryang. Lt. Thompson, pilot for General Keiser, flew 30 C-21 missions, and 29 C-27 missions in September. Most of these were for the General staff.

ARMY AVIATION SECTION
HEADQUARTERS COMPANY
2ND INFANTRY DIVISION
A.P.O. 248 c/o P.M.
SAN FRANCISCO, CALIFORNIA

September 1950

Fri. 1 September 50

L-16	#458	Thompson	07:15	Rd - Strip	Ivanhoe 6	C-27
L-16	#996	Marohn	07:00	Front - Index	Reiser-Obsvr.	C-21
L-16	#805	Richards	08:40	Front - Index	Flowers-Obsvr.	C-21
L-16	#999	Baugh	10:20	Front - Index	Holland-Obsvr.	C-21
L-16	#805	Richards	12:00	Front - Index	Kinnis-Obsvr.	C-21
L-16	#455	Lawrence	09:00	Pohang	Chaplain	C-27
L-16	#451	Ryan	09:00	Pohang	Hightower	C-21
L-16	#998	Roush	13:40	Front - Index	Flowers-Obsvr.	C-21
L-16	#805	Richards	15:20	Front - Index	Kinnis-Obsvr.	C-21
L-16	#998	Roush	17:00	Front - Index	Flowers-Obsvr.	C-21
L-16	#996	Marohn	10:30	7drop-Missions	Cathcart	C-3
L-16	#999	Baugh	10:30	Drop-Missions	Holland	C-3
L-16	#999	Baugh	13:00	Drop-Mission	Holland	C-3
L-16	#999	Baugh	14:00	Drop-Mission	Correspondent	C-3
L-16	#999	Baugh	15:00	Drop-Mission	Thomas	C-3
L-16	#999	Baugh	15:00	Drop-Mission	Zadai	C-3
L-16	#999	Baugh	08:00	CP. R/S		C-27
L-16	#455	Lawrence	10:30	2 Drop-Missions	Brosnahan	C-3
NOTE: C-3 missions dropped approx. 2000 lb. of supplies						
L-16	#998	Roush		D.S.	Pohang	

Sat. 2 September 50

L-16	#458	Thompson	09:45	Ivanhoe - Rd/S	Armstrong	C-27
L-17	#032	Lawrence	09:40	Pusan		C-27
L-16	#455	Roush	09:40	Pusan	R/T-Lawrence	C-27
L-16	#999	Baugh	09:45	Ivanhoe - Rd/S		C-27
L-16	#455	Roush	11:00	Ivanhoe - Rd/S	Observer	C-21
L-16	#805	Lawrence	11:40	Rd/S	Armstrong	C-27
L-16	#805	Richards	13:05	Fwd - Rd /S		C-27
L-16	#998	Armstrong	13:50	Drop - Mission	Raan	C-3
L-16	#455	Lawrence	13:50	Drop - Mission	Nogelmeier	C-3
L-16	#996	Marohn	13:50	Drop - Mission	Cathcart	C-3
L-16	#455	Lawrence	14:35	Div. Arty Strip		C-27
L-16	#455	Lawrence	18:45	Forward strip		C-27
L-16	#998	Armstrong	18:20	Forward strip		C-27
L-16	#996	Roush	18:25	Front		C-21
L-16	#996	Marohn	15:30	Front		C-21
L-16	#805	Richards	16:00	C-3 Drop	Brosnahan	C-3
L-16	#998	Roush	16:00	Drop Mission	Raan	C-3
L-16	#999	Baugh	17:00	Front		C-21
L-16	#451	Ryan		D.S.	9th Inf.	

Sun. 3 September '50

L-16	#458	Thompson	06:55	Fwd Rd/Strip	Ivanhoe 6	C-27
L-16	#805	Richards	07:00	Rd/S Ivory	Courier	C-21
L-16	#996	Marohn	09:45	R/S Front	Observer	C-21
L-16	#998	Roush	09:50	38.0 - 86.2	Zadai	C-3
L-16	#458	Thompson	10:40	Rd/Strip	Ivanhoe 6	C-27
L-16	#805	Richards	11:30	R/S - Front	Observer	C-21
L-16	#998	Roush	10:50	38.0 - 86.2	Zadai	C-3
L-16	#455	Baugh	10:50	38.0 - 86.2	Brosnahan	C-3
L-16	#032	Lawrence		K-9	Gardner	S-2
L-16	#996	Marohn	13:30	R/S - Front	Observer	C-21
L-16	#998	Roush	12:45	38.0 - 86.2	Zadai	C-3
L-16	#455	Baugh	12:45	38.0 - 86.2	Brosnahan	C-3
L-16	#998	Roush	15:20	38.0 - 86.2	Zadai	C-3
L-16	#455	Baugh	15:10	38.0 - 86.2	Brosnahan	C-3
L-16	#805	Richards	15:00	R/S - Front	Observer	C-21
L-16	#996	Lawrence	16:35	R/S - Front	Observer	C-21
L-16	#451	Ryan	D.S.	Pohang	Hightower	

Mon. 4 September 50

L-16	#458	Thompson	09:30	Rd/Strip	Ivanhoe 6	C-27
L-16	#996	Marohn	09:30	Rd/Strip	Col. Mc Clain	C-27
L-16	#805	Richards	11:00	Front	Observer	C-21
L-17	#032	Armstrong	11:10	Front - Horsefly	Baugh	C-21
L-16	#455	Roush	11:30	Drop mission	Zadai	C-3
L-16	#996	Marohn	13:40	Front	Observer	C-21
L-16	#998	Roush	15:15	Front	Observer	C-21
L-16	#805	Richards	14:20	Leaflets	Observer	C-21
L-16	#996	Marohn	15:45	Granade Drop	Observer	C-21
L-16	#996	Marohn	16:50	Masan	Col. Mc Clain	C-21 C-27
L-16	#451	Ryan	D.S.	Pohang	Hightower	

Tue. 5 September 50

L-16	#458	Thompson	07:35	Front - Rd/S	Ivanhoe 6	C-27
L-16	#998	Roush	08:00	Rd/Strip	Observer	C-21
L-16	#805	Richards	12:00	Rd/Strip	Observer	C-21
L-16	#451	Ryan	D.S.	Pohang	Hightower	

RAINED OUT

Wed. 6 September 50

L-16	#458	Thompson	07:15	Rd/Strip	Ivanhoe 6	C-27
L-16	#999	Baugh	08:00	Front	Observer	C-21
L-16	#455	Lawrence	10:15	Front	Observer	C-21
L-16	#998	Roush	12:00	Front	Observer	C-21
L-16	#805	Richards	14:00	Front	Observer	C-21
L-16	#999	Armstrong	14:00	Front	Observer	C-21
L-16	#996	Marohn	18:00	Front	Observer	C-21
L-17	#032	Baugh	13:00	Horsefly	Raan	C-21
L-16	#805	Richards	08:00	Index A/S	Lt. Col. Holden	C-27
L-16	#996	Armstrong	09:35	Rd/Strip		C-27
L-16	#805	Richards	10:45	Ivory A/S	Ivanhoe 3	C-27

Wed. 6 September 50 Con't.

L-16	#999	Lawrence	10:45	Front	Maj. Hill	C-21
L-16	#455	Lawrence	13:50	Kyong-Ju	Col. Granholm	C-27
L-17	#032	Baugh	15:10	Horse fly		C-21
L-16	#996	Marohn	14:55	R/S Fwd	Armstrong	C-27
L-16	#455	Lawrence	17:05	Kyong-Ju	Col. Granholm	C-27
L-16	#451	Ryan	D.S.	Pohang	Hightower	

Thu. 7 September 50:

L-16	#458	Thompson	07:35	R/S Fwd	Ivanhoe 6	C-27
L-16	#999	Roush	08:00	R/S Front	Observer	C-21
L-16	#805	Richards	10:00	R/S Front	Observer	C-21
L-16	#996	Marohn	12:00	R/S Front	Observer	C-21
L-16	#455	Lawrence	14:00	R/S Front	Observer	C-21
L-16	#996	Armstrong	16:00	R/S Front	Observer	C-21
L-16	#455	Baugh	18:00	R/S Front	Observer	C-21
L-17	#032	Hoffman	11:00	Horsefly	Hall	C-21
L-16	#455	Lawrence	08:25	Masan	Lt. Mc Donald	C-27
L-16	#996	Baugh	08:30	R/S Fwd	Hoffman	C-27
L-16	#455	Lawrence	10:00	Masan	Benowski	C-27
L-16	#455	Lawrence	11:20	Pusan/R	Gen. Aiken's party	C-27
L-16	#805	Richards	13:00	R/S Fwd	Dr Tradup	C-27
L-16	#999	Roush	13:25	R/S Fwd	Benowski	C-27
L-17	#032	Baugh	14:30	Pusan	Gen. Aiken	C-27
L-17	#032	Baugh	16:00	Pusan R/S	Gen Aiken Party	C-27
L-16	#999	Hoffman	14:50	R/S Fwd	Hall	C-27
L-16	#805	Richards	16:30	R/S Fwd	Maj. Wilkins	C-21
L-16	#999	Roush	19:10	Pusan	Sgt. Hunsicker	C-27
L-16	#451	Ryan	D.S.	Pohang	Hightower	

Fri. 8 September 50:

L-16	#458	Thompson	08:00	R/S	Ivanhoe 6	C-27
L-16	#805	Richards	08:00	R/S Front	Observer	C-21
L-16	#999	Armstrong	08:10	R/S Front	Request (Additional)	C-21
L-16	#451	Ryan	D.S.	Pohang	Hightower	

Sat. 9 September 50:

L-16	#458	Thompson	07:15	Rd/S Front	Ivanhoe 6	C-27
L-16	#455	Lawrence	08:00	Rd/S Front	Observer	C-21
L-16	#999	Roush	13:15	Rd/S Front	Observer	C-21
L-16	#805	Richards	15:00	Rd/S Front	Observer	C-21
L-16	#996	Marohn	17:00	Rd/S Front	Observer	C-21
L-16	#455	Baugh	14:20	R/S Special	CIC	C-21
L-16	#032	Lawrence	09:30	K-9	Gen Coulter	C-27
L-16	#455	Lawrence	15:00	Rd/S Special	CIC	C-21
L-17	#032	Baugh	16:00	Inspire	Minnis-Holland	C-21
L-16	#451	Ryan	D.S.	Pohang	Hightower	

Sun. 10 September 50:

L-16	#458	Thompson	07:35	R/S	Ivanhoe 6	C-21
L-17	#032	Lawrence	09:45	Taegu	Jackson 6	C-27
L-16	#455	Baugh	07:00	R/S Front	Observer	C-21
L-16	#999	Roush	09:00	R/S Front	Observer	C-21
L-16	#996	Armstrong	11:00	R/S Front	Observer	C-21
L-16	#455	Baugh	13:15	R/S Front	Lt. Olson	C-21
L-16	#455	Thompson	17:00	R/S Front	Observer	C-21
L-16	#999	Marohn	18:00	R/S Front	Observer	C-21
L-16	#996	Marohn	09:35	R/S Fwd	Armstrong	C-27
L-16	#805	Richards	10:30	R/S Fwd	Engr. Officer	C-21
L-16	#999	Marohn	11:25	Ivory R/S	Ivory Ln.C	C-27
L-16	#805	Marohn	14:00	R/S		C-27
L-17	#032	Lawrence	15:30	Taegu		C-27
L-16	#999	Armstrong	15:20	Rd/S	Brosnahan	C-27
L-16	#451	Ryan	D.S.	Pohang	Hightower	C-27

Mon. 11 September 50:

L-16	#458	Thompson	07:15	R/S	Ivanhoe 6	C-27
L-17	#032	Baugh	06:10	Horsefly	Raen	C-21
L-16	#999	Roush	07:00	R/S Front	Observer	C-21
L-16	#455	Lawrence	08:50	R/S Front	Observer	C-21
L-16	#999	Marohn	11:00	R/S Front	Observer	C-21
L-16	#455	Armstrong	13:00	R/S Front	Observer	C-21
L-16	#455	Lawrence	18:00	R/S Front	Observer	C-21
L-16	#451	Ryan	16:45	R/S Front	Observer	C-21
L-16	#996	Marohn	13:40	R/S	Lt. Holland	C-21
L-16	#996	Marohn	07:20	Local	Marinick	C-24
L-16	#996	Armstrong	08:00	Pusan	Reiser	C-27
L-16	#999	Roush	10:30	Pohang	Thompson J.P.	C-21
L-16	#996	Marohn	09:00	Rd/S	Armstrong	C-27
L-17	#032	Baugh	16:00	Horsefly	Marohn	C-21
L-16	#455	Lawrence	11:10	R/S	Armstrong	C-27
L-16	#805	Richards	D.S.	Pohang	Zadai	C-27

Tue. 12 September 50:

L-16	#458	Thompson	07:15	R/S Fwd	Ivanhoe 6	C-27
L-16	#996	Lawrence	09:00	R/S Front	Observer	C-21
L-16	#999	Roush	09:00	R/S Front	Observer	C-21
L-16	#451	Ryan	11:00	R/S Front	Observer	C-21
L-16	#999	Marohn	13:00	R/S Front	Observer	C-21
L-16	#451	Ryan	15:00	R/S Front	Observer	C-21
L-16	#999	Roush	17:00	R/S Front	Observer	C-21
L-17	#032	Baugh	06:00	Horsefly	Reiser	C-21
L-16	#996	Lawrence	09:40	R/S		C-21
L-16	#996	Hoffman	10:00	Pusan		C-21
L-16	#451	Roush	14:10	Lcl Area Photog.	Photogr	C-21
L-17	#032	Hoffman	14:30	Horsefly	Baugh	C-21
L-17	#032	Lawrence	18:15	Horsefly	Lt. Thompson	C-21
L-16	#805	Richards	D.S.	Pohang	Zadai	C-21

Wed. 13 September 50:

L-16	#458	Thompson	07:00		Rd/S	Ivanhoe 6	C-27
L-16	#451	Ryan	07:00	08:45	R/S Front	Observer	C-21
L-16	#455	Lawrence	09:00	09:40	R/S Front	Observer	C-21
L-16	#999	Roush	11:00	11:20	R/S Front	Observer	C-21
L-16	#451	Ryan	15:00	16:00	R/S Front	Observer	C-21
L-16	#996	Marohn	07:00	08:30	Rd/S	Gen. Bradley	C-27
L-16	#996	Marohn	10:40	13:15	Index section	Dayton	C-21
L-16	#455	Baugh	13:10	14:50	Index	Kayser	C-21
L-16	#996	Marohn	13:45	16:10	Index	Dayton	C-21
L-16	#458	Thompson	18:10	19:10	Drop Leaflet	Observer	C-21
L-16	#805	Richards	D.S.		Pohang	Zadai	

Thu. 14 September 50:

L-16	#458	Thompson	07:00	14:40	R/S	Ivanhoe 6	C-27
L-16	#999	Roush	07:10	09:10	R/S Front	Observer	C-21
L-16	#451	Ryan	11:00	11:35	R/S Front	Observer	C-21
L-16	#455	Lawrence	13:00	14:35	R/S Front	Observer	C-21
L-16	#999	Baugh	15:00	16:50	R/S Front	Observer	C-21
L-16	#455	Lawrence	17:00	18:00	R/S Front	Observers	C-21
L-16	#996	Marohn	10:30	13:00	Index Rear	Adj/Fire	C-21
L-16	#455	Armstrong	08:25	09:45	R/S Fwd		C-27
L-17	#032	Baugh	08:20	09:40	R/S Fusan	Minnis	C-27
L-16	#805	Richards	09:45	12:05	Div/Rd S	Impell Blue 6	C-21
L-16	#805	Richards	13:00	14:10	Rd/S	Impell Blue 6	C-21
L-16	#996	Marohn	13:25	16:05	Index Rear	Dayton	C-21
L-16	#805	Richards	14:45	16:15	Ivory Strdp	Observer	C-21
L-16	#458	Thompson	14:50		Rd/S	Ivanhoe 6	C-27
L-16	#996	Ryan	16:15	18:25	Index rear		C-21
L-17	#032	Roush	16:40	17:45	Fusan	Minnis	C-27
L-16	#805	Armstrong	16:50	18:05	R/S	Hammon	C-27
L-16	#996	Marohn	07:40	10:05	Index rear	Dayton	C-21

Fri. 15 September 50:

L-16	#805	Richards	07:00	08:15	Front	Observer	C-21
L-16	#999	Roush	09:00	09:15	R/S Front	Observer	C-21
L-16	#455	Lawrence	11:00	11:45	R/S Front	Kay	C-21
L-16	#451	Ryan	13:00	14:15	R/S Front	Morton	C-21
L-16	#805	Richards	15:00	16:15	R/S Front	Dayton	C-21
L-16	#455	Lawrence	17:00	18:55	R/S Front	Observer	C-21
L-16	#451	Ryan	08:00	11:00	Sabre R/Track	Lt. Wood	C-27
L-16	#996	Marohn	10:00	10:40	Ivory F/S		C-21
L-16	#805	Richards	13:00	13:50	Index F/S	Index2	C-21
L-16	#805	Armstrong	10:40	11:50	Miryang		C-27
L-16	#999	Roush	13:10	17:15	Ivory F/S	Maj Schwartz	
						Insoire R/W, Blue	
L-16	#996	Armstrong	14:00	14:10	Maryang area		C-27
L-16	#996	Armstrong	15:30	16:45	K-9 Fusan	Maj. Hall	C-27
L-16	#451	Ryan	16:10	16:35		Lt. Sexton	C-21
L-16	#996	Armstrong	16:55	17:45	Front	Dayton	C-21

Sat. 16 September 50:

L-16	#455	Lawrence	07:00	08:00	Front	Morton	C-21
L-17	#032	Baugh	06:25	09:50	Front		C-21
L-16	#999	Roush	08:00	09:15	Front	Dayton	C-21
L-16	#451	Ryan	09:00	10:40	Front	Kay	C-21
L-17	#032	Baugh	10:05	13:05	Horsefly		C-21
L-17	#032	Baugh	14:00	17:50	Horsefly	Cethcart	C-21
L-16	#455	Lawrence	12:00	12:20	Front		C-21
L-16	#805	Richards	14:15	16:05	Index F/S	Maj. Sims	C-21
L-16	#999	Roush	14:00	15:30	Front	Dayton	C-21
L-16	#451	Ryan	15:00	17:00	Front	Kay	C-21
L-16	#996	Armstrong	16:00	17:25	Front	Morton	C-21
L-16	#805	Richards	17:00	18:40	Front	Dayton	C-21
L-16	#999	Roush	10:35	11:45	Front	Lt. Kanelis	C-27
L-16	#458	Thompson	13:45	14:10	W/Check	Lt. Jackson	C-27
L-16	#455	Lawrence	15:40	16:25	Ivory F/S	A/C Radio Dp	C-27

Sun. 17 September 50:

L-17	#032	Baugh	14:25	15:25	Horsefly	Lawrence	C-21
L-16	#451	Ryan	07:00	08:45	Front	Kay	C-21
L-16	#999	Roush	08:00	09:10	Front	Dayton	C-21
L-16	#455	Lawrence	08:30	09:30	Front	Holland	C-21
L-16	#805	Richards	09:00	10:40	Front	Dayton	C-21
L-16	#996	Armstrong	10:00	11:30	Front	Kay	C-21
L-16	#455	Lawrence	11:00	12:00	Front	Morton	C-21
L-16	#999	Hoffman	10:00	13:30	Pusan	Hoffman	C-27
L-16	#451	Ryan	12:00	13:05	Front	Dayton	C-21
L-16	#996	Roush	12:55	13:35	Front	Kay	C-21
L-16	#805	Richards	14:00	15:10	Front	Morton	C-21
L-16	#996	Armstrong	15:00	16:25	Front	Dayton	C-21
L-16	#451	Ryan	16:00	17:10	Front	Kay	C-21
L-16	#999	Roush	16:25	17:00	Front	Col. Porter	C-21
L-16	#805	Richards	17:00	18:20	Front	Morton	C-21
L-16	#455	Lawrence	17:30	18:10	Ivory A/S	Maj. Schwartz	C-27

Sun. 18 September 50:

L-16	#458	Thompson	10:45	11:30	Index-201	Dayton	C-21
L-16	#999	Roush	07:00	09:15	Miryang-Pusan	Capt. Price	C-27
L-16	#805	Richards	06:45	08:10	Index sector	Dayton	C-21
L-16	#451	Ryan	06:50	08:15	Imnel Sector	Kay	C-21
L-17	#032	Baugh	10:25	11:45	Horsefly	Cpl. Thompson	C-21
L-16	#455	Lawrence	08:30	10:55	Ivory F/S	Inspire observer	C-21
L-16	#805	Richards	09:00	10:10	Front	Morton	C-21
L-16	#451	Ryan	09:50	10:25	Index-201	Kay	C-21
L-17	#032	Baugh	13:30	15:15	Masan-Miryang	Al Jolson	C-21
L-16	#999	Roush	10:45	12:15	Ivory F/S	Inspire Observer	C-21
L-16	#805	Richards	11:30	12:10	Ivory F/S	Inspire Observer	C-21
L-16	#458	Thompson	11:50	12:50	Index-201	Kay	C-21

Mon. 18 September 50 con't

L-16	#451	Ryan	13:00	13:55	Front	Morton	C-21
L-16	#455	Lawrence	13:00	15:05	Impel Sector	Brosnahan	C-21
L-16	#999	Roush	13:50	14:50	Index-201	Gen. Bardley	C-21
L-16	#805	Richards	14:00	15:25	Front	Dayton	C-21
L-16	#996	Armstrong	15:00	16:45	Front	Kay	C-21
L-16	#451	Ryan	15:00	16:30	Impel sector	Adams	C-21
L-16	#458	Thompson	13:40	14:55	Ivory F/S	Maj. Schwartz	C-21
L-16	#996	Armstrong	13:45	14:25	Ivory F/S		C-27
L-16	#999	Roush	17:00	18:00	Front	Dayton	C-21
L-16	#999	Roush	15:00	15:45	Index-201	Gen. Bradley Aide	C-21
L-16	#455	Lawrence	16:00	17:10	Front	Morton	C-21
L-16	#805	Richards	16:30	18:00	Impel sector	Zadai	C-21
L-16	#455	Lawrence	17:55	18:35	Front		C-21
L-17	#032	Baugh	18:30	19:15	Horsefly	Richards	C-21
L-16	#458	Thompson	17:55	18:35	Front	Kay	C-21
L-16	#996	Hoffman	17:50	18:40	Ivory & Front	Hall	C-21

Tue. 19 September 50:

L-16	#455	Lawrence	06:00	07:15	Front	Morton	C-21
L-16	#451	Ryan	07:00	08:15	Front	Dayton	C-21
L-16	#805	Richards	08:00	09:05	Front	Kay	C-21
L-16	#999	Roush	08:00	09:20	Front	Sathcart	C-21
L-16	#455	Lawrence	08:30	11:40	Ivory F/S	Inspire 2-3	C-21
L-17	#032	Baugh	08:45	10:50	Horsefly	Zadai	C-21
L-16	#996	Armstrong	09:00	10:40	Front	Morton	C-21
L-16	#451	Ryan	10:00	11:25	Front	Dayton	C-21
L-16	#805	Richards	10:35	11:10	Sin Dan ni	Flowers	C-21
L-16	#999	Roush	11:00	12:00	Front	Kay	C-21
L-17	#032	Baugh	11:30	13:50	Horsefly	Armstrong	C-21
L-16	#805	Richards	12:00	13:20	Front	Morton	C-21
L-16	#455	Ryan	13:00	14:35	Front	Dayton	C-21
L-16	#999	Roush	14:00	15:10	Front	Kay	C-21
L-16	#996	Richards	15:00	16:20	Front	Morton	C-21
L-16	#996	Armstrong	16:00	17:35	Front	Dayton	C-21
L-16	#932	Olson	14:15	RCN	Fusan		C-27
L-16	#455	Baugh	15:15	17:25	Ivory F/S for Invest		C-21
L-17	#032	Lawrence	14:20	18:20	Horsefly	Brosnahan	C-21

Wed. 20 September 50:

L-16	#455	Baugh	06:00	08:00	Ivory F/S	Observer	C-21
L-17	#032	Lawrence	07:05	10:50	Horsefly	Observer	C-21
L-16	#458	Thompson	07:30	08:05	Ivanhoe F/S	Armstrong	C-21
L-16	#805	Richards	08:00	09:35	Ivory F/S	Observer	C-21
L-16	#999	Roush	10:00	11:45	Ivory F/S	Observer	C-21
L-16	#451	Ryan	12:00	13:50	Ivory F/S	Observer	C-21
L-16	#805	Richards	14:00	15:40	Ivory F/S	Observer	C-21

Wed. 20 September 50 Con't

L-16 #999	Roush	14:25	15:25	Impel area	Observer	C-21
L-5 #932	Olson	RON	14:50	Fusan	Observer	C-21
L-16 #455	Armstrong	15:30	17:15	Ivanhoe F/S	Baugh	C-21
L-16 #458	Thompson	16:00	17:35	Ivory F/S	Observer	C-21

Thu. 21 September 50:

L-16 #451	Ryan	06:00	11:20	Taegu	Lt. Carl.	C-21
L-16 #805	Richards	08:00	09:35	Front	Morton	C-21
L-16 #458	Thompson	10:00	11:20	Front	Kay	C-21
L-16 #805	Richards	10:45	11:50	409	Capt. Lieber	C-21
L-16 #999	Baugh	11:45	12:45	Front	Franklin	C-28
L-16 #996	Roush	12:00	13:10	Front	Dayton	C-21
L-16 #458	Thompson	13:00	14:25	Front	Morton	C-21
L-16 #805	Richards	13:25	14:10	Front	Photog	C-28
L-5 #932	Olson	14:00	14:55	Front	Dayton	C-21
L-16 #805	Ryan	15:00	16:35	Front	Kay	C-21
L-5 #932	Richards	17:00	18:00	Front	Dayton	C-21
L-17 #032	Baugh	16:30	18:00	Horsefly	Roush	C-21

Fri. 22 September 50

L-16 #455	Lawrence	06:00	08:10	H-409	Observer	C-21
L-16 #999	Roush	07:00	08:10	Front	Kay	C-21
L-17 #032	Baugh	07:35	08:40	Horsefly	Holland	C-21
L-16 #451	Ryan	09:00	10:00	Front	Dayton	C-21
L-16 #455	Lawrence	09:50	11:10	H-409	Trimble	C-21
L-5 #932	Olson	10:30	13:05	Horsefly	Dayton	C-21
L-16 #805	Richards	11:00	12:05	Patrol	Gilley	C-21
L-16 #999	Roush	10:45	12:20	Fusan		C-27
L-17 #032	Baugh	10:50	repr.	Fusan		C-27
L-16 #451	Ryan	13:40	14:45	Front	Lt. McDonald	C-21
L-16 #805	Richards	13:15	14:00	Front	Franklin	C-21
L-16 #999	Roush	15:00	16:30	Front	Gilley	C-21
L-16 #455	Lawrence	15:05	16:25	H-409	Trimble	C-21
L-16 #805	Richards	17:00	18:00	Front	Kay	C-21
L-16 #458	Thompson	16:45	18:00	8th Army	Maj. Walter	C-27
L-5 #932	Olson	17:00	18:00	Miryang	Air Evac.	C-4
L-5 #932	Olson	18:05	18:30	Miryang	Air Evac.	C-4
L-5 #932	Olson	18:45	RON	Miryang	Air Evac.	C-4

Sat. 23 September 50

L-10 #455	Lawrence	16:05	18:00	H-409	O'Brien	C-21
L-16 #805	Richards	07:00	08:10	Patrol	Dayton	C-21
L-16 #999	Armstrong	08:00	09:25	Patrol	Kay	C-21
L-16 #451	Ryan	11:00	12:05	Patrol	Dayton	C-21
L-5 #932	Olson	09:30	10:25	Horsefly		C-21

Sat. 23 September 50 Con't

L-16	#458	Thompson	09:25	10:35	Front	Ivanhoe 6	C-21
L-5	#932	Baugh	11:30	13:25	Horsefly	Holland	C-21
L-16	#451	Ryan	13:00	14:10	Front	Kay	C-21
L-16	#458	Thompson	14:30	15:30	Hill-409	Gen. Bradley	C-21
L-16	#455	Baugh	13:45	14:20	Miryang	Colonel ?	C-27
L-16	#805	Thompson	13:45	14:20	Miryang	Gen Coulter	C-27
L-5	#932	Olson	14:10	15:25	Horsefly	Dayton	C-21
L-16	#805	Baugh	15:45	16:45	Front	COL. Sloane	C-21
L-16	#451	Ryan	15:00	16:10	Patrol	Kay	C-21
L-16	#999	Roush	17:00	17:50	Patrol	Dayton	C-21
L-16	#458	Thompson	16:40	17:20	Special	Lt. Ruggiero	C-21
L-5	#932	Baugh	18:25	19:05	Horsefly Hyopchon		C-21

Sun. 24 September 50:

L-16	#458	Thompson	06:50	07:15	Hyopchon	Lt. Holland	C-21
L-16	#455	Lawrence	06:45	08:25	Hill-409	O'Brien	C-21
L-16	#451	Ryan	07:00	08:20	Patrol	Kay	C-21
L-16	#805	Richards	08:30	11:00	Miryang	Lt. Wood	C-21
L-16	#999	Roush	09:00	10:30	Patrol	Dayton	C-21
L-16	#999	Roush	11:25	11:35	Lcl	Photographer	C-28
L-16	#451	Armstrong	09:15	10:25	Front	Lt. Holland	C-21
L-16	#451	Ryan	11:00	12:35	Front	Franklin	C-28
L-16	#455	Lawrence	12:25	14:15	H-409	O'Brien	C-21
L-16	#999	Roush	13:00	14:10	Patrol	Dayton	C-21
L-16	#458	Thompson	13:10	18:15	Observer	Ivanhoe 6	C-27
L-16	#805	Richards	13:15	14:20	Patrol	Carl I	C-21
L-16	#451	Ryan	14:05	15:30	Patrol	Franklin	C-21
L-16	#999	Baugh	15:00	16:55	Patrol	Kay	C-21
L-5	#932	Olson	14:45	18:20	Horsefly	Cathcart	C-21
L-16	#455	Lawrence	15:50	17:55	Special	O'Brien	C-21
L-16	#805	Roush	16:25	16:55	Patrol	Dayton	C-21
L-16	#932	Olson	16:25	17:20	Thague	Col. Adams	C-27

Mon. 25 September 50:

L-16	#451	Ryan	08:00	09:30	F/S	Lt. McDonald	C-21
L-16	#999	Roush	08:10	09:45	F/S	Armstrong	C-27
L-16	#458	Thompson	07:30	09:35	Miryang	Holland	C-27
L-16	#455	Lawrence	07:20	09:15	Hill-409	O'Brien	C-27
L-16	#805	Richards	08:20	09:50	Miryang	Lt. Carlt	C-27
L-16	#805	Richards	10:00	11:20	Patrol	Dayton	C-21
L-5	#932	Olson	10:30	13:00	Rd/Recn	Capt. Wurla	C-21
L-16	#805	Ryan	11:50	12:10	F/S	Lt. McDonald	C-27
L-16	#451	Baugh	10:30	12:50	IX Corp Miryang	Lt. Carlt	C-27
L-16	#999	Roush	12:00	13:35	Patrol	Morton	C-21
L-16	#458	Thompson	14:05	16:05	Patrol	Kay	C-21
L-16	#455	Lawrence	13:30	15:30	Spec. Patrol	O'Brien	C-21
L-16	#451	Ryan	13:25	14:15	IX Corp F/S	Lt. Carlt	C-27
L-16	#805	Richards	14:25	17:00	F/S	Gilley	C-21

Mon. 25 September 50: Con't

L-5	#932	Baugh	14:40	15:40	Recn	Holden	C-21
L-16	#999	Roush	16:15	18:00	F/S Miryang	Col. Harris	C-27
L-5	#932	Olson	16:00	18:55	Horsefly	Dayton	C-21
L-16	#455	Lawrence	16:30	18:35	H-409	O'Brien	C-21
L-16	#451	Ryan	17:15	17:50	35-87	Hightower	C-21

Tue. 26 September 50: Moved- Changang to Naktong River

L-16	#455	Lawrence	06:15	07:20	Hill-409	O'Brien	C-21
L-16	#999	Armstrong	08:15	08:30			C-27
L-16	#458	Thompson	08:00	09:30	Front	Ray	C-21
L-16	#805	Richards	08:15	09:00	Miryang	Maj. Allen	C-27
L-16	#451	Ryan	08:15	14:55	Miryang	Gen. Coulter	C-27
L-5	#932	Baugh	09:30	09:45	Miryang F/S	Capt Bailey	C-27
L-16	#458	Thompson	11:30	12:55	Patrol	Dayton	C-21
L-16	#999	Baugh	10:15	11:40	Patrol	Kay	C-21
L-16	#455	Lawrence	10:00	11:45	H-409	O'Brien	C-21
L-16	#805	Richards	12:55	13:35	IX Corps Miryang	Maj. Allen	C-27
L-16	#805	Richards	13:40	14:20	IX Corps Miryang	Lt. Sanders	C-27
L-5	#932	Baugh	13:35	14:15	Miryang	Patient	C-4
L-16	#458	Thompson	14:00	17:10	Patrol	Dayton	C-21
L-16	#455	Lawrence	14:20	16:15	H-409	O'Brien	C-21
L-16	#999	Roush	13:15	13:55	F/S	Armstrong	C-27
L-16	#805	Richards	15:20	17:25			C-27
L-16	#451	Ryan	15:20	17:25			C-27
L-16	#999	Roush	15:25	16:45	Patrol	Borton	C-21
L-5	#932	Baugh	16:00	17:30	Horsefly	Minnis	C-21

Wed. 27 September 50: Moved- Naktong River to Hyopchon

L-16	#451	Ryan	07:15	08:30	Patrol	Borton	C-21
L-16	#999	Roush	07:25	08:00	F/S	Armstrong	C-27
L-5	#932	Baugh	08:00	10:00	Miryang	Patient	C-4
L-16	#455	Lawrence	07:50	10:55	Hill-409	O'Brien	C-21
L-16	#999	Roush	08:30	12:00			C-27
L-16	#455	Lawrence	12:10	14:00	H-409	O'Brien	C-21
L-16	#805	Richards	10:00	11:30	Patrol	Dayton	C-21
L-16	#458	Thompson	09:00	10:00	Patrol	Kay	C-21
L-16	#458	Thompson	11:00	12:00	Patrol	Kay	C-21
L-16	#805	Baugh	11:00	12:15	Patrol	Holland	C-21
L-16	#999	Roush	13:10	14:40	Miryang	Bailey	C-27
L-5	#932	Baugh	13:30	16:05	Horsefly		C-21
L-16	#805	Richards	14:00	16:15	Patrol	Dayton	C-21
L-16	#458	Thompson	16:15	17:20	Patrol		C-21
L-16	#999	Roush	16:20	17:45	Patrol	Holland	C-21
L-5	#032	Baugh	16:35	18:35	Horsefly		C-21
L-16	#455	Lawrence	15:50	17:50	H-409	O'Brien	C-21

Thr. 28 September 50:

		Moved- Hyopshan to Kolhang					
L-16	#458	Thompson	07:00	08:40	Taegue-Miryang	Gen Coulter	C-27
L-16	#451	Ryan	07:20	11:00	Samga Area	Index 3	C-21
L-16	#805	Richards	08:00	09:15	Patrol	Observer	C-21
L-16	#455	Lawrence	07:55	10:00	Patrol	Holland	C-21
L-5	#932	Baugh	09:00	12:30	Horsefly		C-21
L-16	#451	Ryan	13:00	14:00	Miryang	Wood	C-21
L-16	#805	Richards	10:00	11:30	Patrol	Dayton	C-21

Fri; 29 September 50:

L-16	#455	Thompson	08:00	09:35	Miryang	Nance	C-27
L-16	#805	Richards	10:15	12:30	Miryang	Smith	C-27
L-16	#458	Thompson	10:10	13:20	ChanJu	Morton	C-21
L-16	455	Lawrence	10:45	16:05	Adm. Recon.	Burla	C-21
L-16	451	Ryan	12:00	13:10	Patrol	Kay	C-21
L-16	#999	Roush	13:25	17:05	Patrol	Holland	C-21
L-16	#451	Ryan	14:00	18:00	Patrol	Observer	C-21
L-16	#458	Thompson	14:25	Ron		Armstrong	C-27
L-16	#805	Richards	16:00	18:00	Patrol	Observer	C-21
L-5	#932	Baugh	17:10	18:30	Miryang	Patient	C-4

Sat. 30 September 50:

		Moved- Kolchang to ChonJu					
L-16	#805	Richards	06:30	08:15	Patrol	Kay	C-21
L-16	#451	Ryan	08:00	10:40	Patrol	Observer	C-21
L-16	#805	Richards	09:30	10:15	Lcl		C-27
L-16	#999	Roush	10:00	11:05	Patrol	Observer	C-21
L-16	#805	Richards	10:50	11:45	Chon Ju		C-27
L-5	#932	Baugh	16:00	17:10	Chon Ju	Armstrong	C-27
L-16	#805	Richards	13:00	14:45	Lcl		C-27
L-16	#455	Lawrence	16:55	18:15	Chon Ju		C-27
L-16	#458	Thompson	06:55	08:15	Patrol	Observer	C-21
L-16	#458	Thompson	12:10	13:00	Lcl		C-27
L-16	#458	Thompson	15:30	16:25	Lcl	V/Gen. Bradley	C-27
L-16	#458	Thompson	16:55	18:20	Patrol	Observer	C-21
L-16	#999	Roush	13:00	14:30	Chon Ju		C-27

ARMY AVIATION SECTION
 HEADQUARTERS COMPANY
 2ND INFANTRY DIVISION
 A.P.O. 248 c/o P.M.
 SAN FRANCISCO, CALIFORNIA

1 October 1950

SUBJECT: Monthly Report of Aviation Activity.

TO : Commanding General
 Eighth United States Army in Korea

Attn : Army Aviation Officer

1. In compliance with verbal instructions, your headquarters, the following report is submitted for the month of September, 1950.

a. T/O Officer Aviator Personnel:

UNIT	NAME	GRADE	ASN	CAT	FLYING TIME		TOTAL
					DAY	NIGHT	
Hq 2d Div.	Hoffman R.L.	Capt.	01176669	III	6:00	0	6:00
Hq Co 2d Div.	Armstrong, W.L.	Capt.	0405007	III	27:00	0	27:00
	Lawrence, G.H.	Capt.	01283798	III	95:00	0	95:00
Hq Div Arty	Baugh, W.A. Jr.	1st Lt.	01339340	III	101:00	0	101:00
	Karohn, R.L.	1st Lt.	01181947	III	52:00	0	52:00
	Richards, B.F.	1st Lt.	060571	RA	107:00	0	107:00
	Roush, J.W.	1st Lt.	01320186	III	90:00	0	90:00
	Ryan, T.K.	1st Lt.	0472142	III	97:00	1:00	98:00
	Thompson, H. A.	1st Lt.	01306175	III	65:00	0	65:00
	Hammons, T.B.	Capt.	01182130	III	63:00	0	63:00
38th FA. Bn.	Kolb, R.W.	Capt.	01287898	III	18:00	0	18:00
	Lewis, M.E.	1st Lt.	059904	RA	34:00	0	34:00
15th FA. Bn.	Aure, G.O.	1st Lt.	01184616	III	151:00	0	151:00
	Guffey, M.C.	1st Lt.	01118723	III	147:00	0	147:00
503rd FA. Bn.	Valdez, I.S.	Capt.	01997748	III	167:00	0	167:00
	Littell, J.L.	1st Lt.	01174632	III	173:00	0	173:00
37th FA. Bn.	Hopkins, P.F.	1st Lt.	02019744	III	170:00	0	170:00
	Woolridge, R.	1st Lt.	01173514	III	123:00	0	123:00
37th FA. Bn.	Black, W.G.	Capt.	01166438	III	184:00	0	184:00
	Morrow, C. Jr.	1st Lt.	058983	RA	169:00	0	169:00

SUBJECT: Monthly Report of Aviation Activity

UNIT	NAME	GRADE	MOS	ASN
Hq. Co. 2d Div	Flowers, Clarence R.	Sgt.	0747	RA 13114563
	Heifner, Claude C.	Sgt.	0747	RA 18060186
	Holland, Elvage	Sgt.	0747	RA 34547172
	Smith, Charles W.	Sgt.	0060	RA 14082814
	Brosnahan, Donald J.	Cpl.	0747	RA 16321543
	Cathcart, Charles W.	Cpl.	0747	RA 19291780
	Dolezal, James F.	Cpl.	0060	RA 16303250
	Hightower, Oscar E.	Cpl.	0747	RA 14065719
	Mermuys, Ralph J.	Cpl.	0861	RA 16276359
	Minnis, Charles E.	Cpl.	0826	RA 19329305
	Nichols, Ralph M.	Cpl.	0648	RA 33968243
	Nogelmeier LuVerne W.	Cpl.	0648	RA 39499451
	Raen, Roger N.	Cpl.	0747	RA 39462038
	Thompson, John P.	Cpl.	0747	RA 14324421
	Zadai, William J.	Cpl.	0747	RA 13349967
	Alberico, Francis A.	Pfc.	0062	RA 11187040
	Kalk, Robert L.	Pfc.	0745	RA 36924520
	Marinick, Nicholas L.	Pfc.	0835	RA 12306920
	Thomas, Llewellyn	Pvt.	0745	RA 13253095
	Hq. Btry 2d Arty	Carr, Harlan O.	Sgt.	0747
Page, Charles A.		Sgt.	3649	RA 6879425
Drozdowski, Edmund		Cpl.	0014	RA 16291978
Fitzgerald, Edward F.		Cpl.	0747	RA 44044182
Hall, James P.		Cpl.	0747	RA 17013960
Hodge, James P.		Cpl.	0060	RA 34258421
15th FA. Bn.		Kasson, Allen R.	Pfc.	4745
	Burnsed, William N.	Cpl.	4844	RA 14237211
	Brursema, Lambert E.	Pfc.	0747	RA 16309585
37th FA. Bn.	Scott, Neal A.	Pfc.	0747	RA 15357465
	Scanlan, John P.	Sgt.	0747	RA 15357379
38th FA. Bn.	McKee, Robert J.	Pvt.	0747	RA 17268852
	Finney, Thomas B.	Sfc.	0014	RA 34904531
	O'Neal, Charles P.	Sgt.	0747	RA 6863728
503rd FA. Bn.	Hill, Darwin W.	Cpl.	0060	RA 17257889
	Warren Kenneth W.	Pfc.	0747	RA 18298102
	Gray, Benjamin	Sgt.	0932	RA 37448858
	Jackson, Joe	Cpl.	0747	RA 57200425
	Jackson, William	Pfc.	0747	RA 12288721

SUBJECT: Monthly Report of Army Aviation Activity

c. Aircraft:

UNIT	NO. AUTH	NO. ASCD	SECRET		MONTHLY TIME
			TYPE	SERIAL NUMBER	
Hq. Co. 2d Inf Div	8	7	L-16B	48-451	110:00
			L-16B	48-455	102:00
			L-16B	48-458	64:00
			L-16A	47-999	81:00
			*L-16A	47-996	63:00
			L-16A	47-805	112:00
			L-17B	48-1032	61:00
			L-5G	45-34932	41:00
Hq. Btry	2	2	L-16A	47-988	147:00
			L-16B	48-456	17:00
15th FA. Bn	2	2	L-16B	48-441	175:00
			L-16A	47-989	173:00
38th FA. Bn.	2	2	L-16A	47-1086	97:00
			L-16A	47-1085	196:00
37th FA. Bn.,	2	3	L-16A	47-1083	47:00
			L-16A	47-998	171:00
			L-16B	48-452	26:00
503rd FA. Bn.	2	2	L-16A	47-1082	126:00
			L-16A	47-1087	176:00

* Indicates plane shipped

d. Aircraft Grounded:

L-17B 48-1032

e. Supply & Maintenance

Need engines and brake clips, for L-16s

f. Flight Information:

- (1) Total number of flights: 1315
- (2) Number of passengers flown: 1180
- (3) Flyable days during month: 30

g. Remarks

- (1) L-16A Shipped to 8th Army 21 September 1950
- (2) L5G Received from 8th Army, 14 September 1950

FOR THE COMMANDING GENERAL:

SECRET

ARMY AVIATION SECTION
HEADQUARTERS COMPANY
2ND INFANTRY DIVISION
A.F.O. 248 c/o P.M.
SAN FRANCISCO, CALIFORNIA

October 1950

SECRET

The 2nd Infantry Division Army Aviation Section arrived at Chonju at 0815 on 1 October 1950, and remained there until the morning of 11 October 1950.

During this period most of the missions were administration and evacuation of patients. Only three or four missions per day were reconnaissance type. The last were mostly south to the vicinity of Mokpo in search of guerilla activity.

On 2 October 1950, L-16 number 47-805 was shipped to 8th Army and was later turned over to a ROK unit. This left us with only five planes in the section.

The sick and wounded that were evacuated were flown to hospitals at Miryang which was a long haul. This was later changed to Suchon on the south coast which was just as far. Finally a few were evacuated to Taejon.

On 11 October 1950, the section moved to Seoul. At this time the Division became Army reserve and all the flights were administrative.

On 13 October 1950, the section received word that three of the officers had been promoted to Captains. They were Captains T.K. Ryan, J.W. Roush and H.A. Thompson.

On 14 October 1950, Capt. G.H. Lawrence and Capt. T.K. Ryan with Cpl. Donald J. Brosnahan and Cpl. Oscar E. Hightower were sent on D.S. to operate with I Corps. They were relieved on 26 October by Capt. F.A. Thompson and 1st Lt. B.L. Richards with Cpl. Raean and Cpl. Zada as mechanics. Capt. Lawrence's plane had to be returned by truck because of a bad engine. This left us with only two planes available at the section.

On 29 October 1950, the section moved to Pyongyang. That trip was the longest one trip made to date. A tire to trailer locked a wheel and has to be repaired. Then one of our three Russian trucks blew a head gasket and had to be towed until another truck of the same model could be found along the roadside. As soon as one was found, the head and head gasket were replaced. All together a delay of over five hours resulted and the section arrived at Pyongyang at K-23 Air Force Field at 0005 on 30 October 1950.

SECRET

The section had a very nice sod strip on the west side of what had been the main airport for Pyongyang.

Several awards were made during October for previous service in September. The following named officers and enlisted men received decorations as follows:

Capt. Armstrong	-	three clusters to Air Medal.
Capt. Hoffman	-	one cluster to Air Medal.
Capt. Lawrence	-	one D.F.C. and five clusters to Air Medal.
Capt. Ryan	-	one D.F.C. and six clusters to Air Medal.
Capt. Roush	-	one D.F.C. and five clusters to Air Medal.
Capt. Thompson	-	one D.F.C. and three clusters to Air Medal.
Lt. Baugh	-	one D.F.C., one cluster to D.F.C., and five clusters to Air Medal.
Lt. Marohn	-	one D.F.C. and two clusters to Air Medal.
Lt. Richards	-	one D.F.C., one cluster to D.F.C., and five clusters to Air Medal.
Sgt. Holland	-	Air Medal.
Cpl. Brosnahan	-	Air Medal.
Cpl. Cathcart	-	Air Medal.
Cpl. Zadal	-	Air Medal.

HEADQUARTERS 2D INFANTRY DIVISION
A.P.O. 248 & Postmaster
San Francisco, California

1 November 1950

SUBJECT: Monthly Report of Aviation Activity

TO : Commanding General
Eighth United States Army in Korea
APO 301 & Postmaster San Francisco, California

ATTN : Army Aviation Officer

1. In compliance with verbal instructions, your headquarters, the following report is submitted for the month of October, 1950.

a. T/O Officer Aviator Personnel:

UNIT	NAME	GRADE	ASN	CAT	FLYING TIME		TOTAL
					DAY	NIGHT	
Hq. 2d Div.	Hoffman, R. L.	Capt.	01176669	III	7:00	0	7:00
Hq. Co. 2d Div	Armstrong, W. L.	Capt.	0409007	III	16:00	0	16:00
	Lawrence, G. H.	Capt.	01283798	III	45:00	0	45:00
	Boush, J. W.	Capt.	01320186	III	45:00	0	45:00
	Ryan, T. K.	Capt.	0472142	III	58:00	0	58:00
	Thompson, H. A.	Capt.	01306175	III	49:00	0	49:00
	Baugh, W. A. Jr.	1st Lt.	01330340	III	58:00	0	58:00
	Marohn, R. L.	1st Lt.	01181947	III	00:00	0	00:00
Hq. Div. Arty	Richards, B. F.	1st Lt.	060471	RA	50:00	0	50:00
	Hammans, T. B.	Capt.	01182130	III	20:00	0	20:00
	Kalb, R. W.	Capt.	01287898	III	34:00	0	34:00
	Lewis, M. E.	1st Lt.	059904	RA	22:00	0	22:00
15th FA. Bn.	Littell, J. L.	Capt.	01174632	III	38:00	0	38:00
	Valdes, I. S.	Capt.	01997748	III	42:00	0	42:00
	Teitelbaum, R. J.	1st Lt.	01180071	III	16:00	0	16:00
37th FA. Bn.	Black, W. G.	Capt.	01166438	III	51:00	0	51:00
	Morrow, C. Jr.	1st Lt.	058983	RA	29:00	0	29:00
38th FA. Bn.	Aure, G. O.	1st Lt.	01184616	III	42:00	0	42:00
	Guffey, M. D.	1st Lt.	01318723	III	49:00	0	49:00
503d FA. Bn.	Hopkins, P. F.	1st Lt.	02019744	III	22:00	0	22:00
	Woolridge, R. H.	1st Lt.	01173514	III	25:00	0	25:00

SUBJECT: Monthly Report of Aviation Activity

UNIT	NAME	GRADE	MOS	ASN	
Hq. Co. 2d Div.	Flowers, Clarence R.	Sfc.	0747	RA 13114563	
	Heifner, Claude G.	Sgt.	0747	RA 18060186	
	Holland, Elvage	Sgt.	0747	RA 34547172	
	Rosen, Roger N.	Sgt.	0747	RA 38462038	
	Smith, Charles W.	Sgt.	0060	RA 11062814	
	Bronnahan, Donald J.	Cpl.	0747	RA 16321543	
	Cathcart, Charles W.	Cpl.	0747	RA 19291780	
	Daleal, James F.	Cpl.	0060	RA 16303250	
	Hightower, Oscar E.	Cpl.	0747	RA 14065719	
	Mormuys, Ralph J.	Cpl.	0861	RA 16276359	
	Minis, Charles E.	Cpl.	0826	RA 19329305	
	Nichols, Ralph M.	Cpl.	0648	RA 33968243	
	Nogelmeier, Lu Verne W.	Cpl.	0648	RA 39499451	
	Thompson, John P.	Cpl.	0747	RA 14324421	
	Zadai, William J.	Cpl.	0747	RA 13349967	
	Kalk, Robert L.	Pfc.	0745	RA 36924520	
	Marinich, Nicholas L.	Pfc.	0835	RA 12306920	
	Thomas, Llewellyn	Pvt.	0745	RA 13253095	
	Hq. Btry 2d Arty	Carr, Marlan O.	Sgt.	0747	RA 17271012
		Page, Charles A.	Sgt.	3649	RA 6879425
Drowdowski, Edmund		Cpl.	0014	RA 16291976	
Fitzgerald, Edward F.		Cpl.	0747	RA 44044162	
Hall, James P.		Cpl.	0747	RA 17013960	
Hodge, Marvin E.		Cpl.	0060	RA 34258421	
Kasson, Allen R.		Pfc.	4745	RA 11154559	
Burnsed, William H.		Cpl.	4844	RA 14237211	
Brussons, Lambert E.		Pfc.	0747	RA 16309585	
Scott, Neal A.		Pfc.	0747	RA 15357465	
37th. FA. Bn.	Scanlan, John P.	Sgt.	0747	RA 15357379	
	McKee, Robert J.	Pvt.	0747	RA 17268852	
38th. FA. Bn.	Finney, Thomas E.	Sfc.	0014	RA 34904531	
	O'Neal, Charles P.	Sgt.	0747	RA 6863728	
	Hill, Darwin W.	Cpl.	0060	RA 17257889	
503rd. FA. Bn.	Warren, Kenneth W.	Pfc.	0747	RA 18298102	
	Gray, Benjamin	Sgt.	0932	RA 37448858	
	Jackson, Joe	Cpl.	0747	RA 57200425	
	Jackson, William	Pfc.	0747	RA 12288721	
	Mathews, Elbert	Cpl.	0060	RA 34028268	

SUBJECT: Monthly Report of Aviation Activity

c. Aircraft:

<u>UNIT</u>	<u>NO. AUTH.</u>	<u>NO. ASCD</u>	<u>TYPE</u>	<u>SERIAL NUMBER</u>	<u>MONTHLY TIME</u>
Hq. Co. 2d Inf. Div.	8	7	*L-16A	47-805	4:00
			L-16A	47-999	52:00
			L-16B	48-451	65:00
			L-16B	48-455	60:00
			L-16B	48-458	61:00
			L-50	45-34932	68:00
			L-17B	48-1029	73:00
			L-17B	48-1032	00:00
			L-16A	47-988	51:00
			L-16B	48-456	16:00
Hq. Stry	2	2	L-16A	47-989	50:00
15th FA. Bn.	2	2	L-16A	47-989	50:00
			L-16B	48-441	56:00
38th FA. Bn.	2	2	L-16A	47-1085	54:00
			L-16A	47-1086	44:00
37th FA. Bn.	2	1	L-16A	47-998	94:00
503rd FA. Bn.	2	2	L-16A	47-1082	28:00
			L-16A	47-1087	25:00

d. A/C Grounded:

- (1) L-16A 47-1087
- (2) L-16B 48-455
- (3) L-17B 48-1032

e. Supplies & Maintenance

- (1) Need engines & brake clips for L-16s
- (2) Need engine propellor & Batteries: For L-17s

f. Flight Information:

- (1) Total number of Flights: 500
- (2) Number of passengers flown: 318
- (3) Flyable days during month: 26

g. Remarks

- (1) L-16A shipped to 8th Army 2 Oct. 50
- (2) L-17B received from 25th Div 28 Oct. 50

FOR THE COMMANDING GENERAL

SECRET

ARMY AVIATION SECTION
HEADQUARTERS COMPANY
2ND INFANTRY DIVISION
A.P.O. 248 c/o P.M.
SAN FRANCISCO, CALIFORNIA

October 1950

	TYPE	AC/NO.	PILOT	OUT	IN	DESTINATION	PASSENGER	TYPE MISSION
Sun. 1 October 50:								
	L-5	#932	Baugh	0600	0745	HoChang		C-21
	L-5	#932	Baugh	0700	1200	NamWan	B/G Bradley	C-27
	L-16	#999	Baugh	1600	1700	Anui	Cpl. Pruett	C-27
	L-16	#455	Lawrence	1000	1110	Lcl		C-27
	L-5	#932	Lawrence	1745		Miryang	Patient	C-4
	L-16	#805	Richards	0730	0820	Lcl		C-27
	L-16	#805	Richards	1200	1300	Lcl		C-27
	L-16	#805	Richards	1440	1540	Patrol	Observer	C-21
	L-16	#455	Armstrong	1720	1820	Patrol	Observer	C-21
	L-5	#932	Roush	1300	1600	Miryang	Patient	C-4
	L-16	#455	Ryan	1600	1730	Patrol	Observer	C-21
	L-16	#999	Roush	0810	0840	Lcl		C-27
	L-16	#999	Roush	1105	1140	Lcl		C-27
Mon. 2 October 50:								
	L-16	#805	Richards	0730		Taegu		C-27
	L-5	#932	Lawrence	RON	0710	Miryang		C-27
	L-5	#932	Baugh	0930	1505	Taegu	Richards	C-27
	L-16	#999	Roush	0745	0855	Namwon	Feavy	C-27
	L-16	#455	Ryan	0830	1215	Miryang	Tanner	C-27
	L-16	#458	Armstrong	0845	0940	Patrol	Jones	C-21
	L-16	#999	Roush	1230	1345	Anui	Sloane	C-27
	L-16	#455	Lawrence	1230	1515	HoChang	Grubb	C-27
	L-16	#458	Thompson	1230	1345	Anui	Gilliam	C-27
	L-5	#932	Baugh	1555	1715	Suchon	Patient	C-4
	L-16	#458	Thompson	1610	1700	YangYong	Perloe	C-27
	L-16	#999	Roush	1615	1805	Anui	Sloane	C-27
Tue. 3 October 50:								
	L-16	#455	Lawrence	0800	1255	Taegu	Div. F.I.O.	C-27
	L-5	#932	Baugh	0750	0730	Suchon	Patient	C-4
	L-16	#999	Roush	0925	1210	KongJu	Maxwell	C-27
	L-16	#458	Armstrong	0905	1200	Kangwong	Perloe	C-21
	L-5	#932	Baugh	1050	1115	Lcl	Cpl. Thompson	C-27
	L-16	#999	Roush	1300	1700	Taejon	Webster	C-27
	L-5	#932	Baugh	1515	1710	Taegu	M/G Margaret	C-27
	L-16	#455	Richards	1420	1730	Namwon	Col. Sinsel	C-27
	L-16	#458	Thompson	1220	1305	Amirillo		C-27
	L-5	#932	Baugh	1330	1505	Suchon	Patient	C-4
	L-16	#458	Thompson	1535	1635	Namwon		C-27

TYPE	A/C NO.	PILOT	OUT	IN	DESTINATION	PASSENGER	MISSION
Wed. 4 October 50:							
L-16	#451	Ryan	1000	1500	Miryang	Barr	C-27
L-5	#932	Hoffman	1330	1435	Lcl	Hall	C-27
L-16	#999	Hume	1600	1745	Lcl	Lidsay	C-21
L-16	#455	Lawrence	1730	1805	Chin Ju	Tennet	C-27
L-16	#455	Ryan	1650	1710	Patrol	Morton	C-21
L-16	#458	Ryan	1730	1815	Patrol	Morton	C-21
L-16	#458	Winley	1435	1535	Lcl		C-27
Thu. 5 October 50:							
L-5	#932	Baugh	0745	0920	Suchon	Patient	C-4
L-16	#458	Thompson	1300	1540	Taegu	Miller	C-27
L-16	#451	Ryan	1300	1620	Taegu	Wilson	C-27
L-16	#999	Roush	0800	1215	Chin Ju	Col. Tanner	C-27
L-5	#932	Baugh	0955	1120	Taegu	Patient	C-4
L-16	#455	Lawrence	0955	1715	Taegu	Sanford	C-27
L-5	#932	Baugh	1200	1410	Suchon	Patient	C-4
L-16	#999	Roush	1345	1500	Kong Ju	King	C-27
L-5	#932	Baugh	1530	1845	Taegu	Miscarson	C-27
Fri. 6 October 50:							
L-5	#932	Baugh	0800	1010	Taejon	Patient	C-4
L-16	#458	Thompson	1300	1640	Taegu	Strom	C-27
L-16	#999	Roush	1330	1615	Kong Ju	B/G Bardley	C-27
L-16	#451	Ryan	1135	1255	Patrol	Morton	C-21
L-16	#455	Armstrong	1300	1515	Patrol	Ray	C-21
L-5	#932	Lawrence	1620	1730	Taejon	Patient	C-4
L-16	#455	Baugh	1700	1855	Munsan		C-21
Sat. 7 October 50:							
L-16	#451	Armstrong	0800	1040	Patrol	Ray	C-21
L-16	#455	Lawrence	0830	1115	Patrol	Observer	C-21
L-16	#458	Richards	0630	1520	Taegu	L/Col. Sinsel	C-27
L-16	#999	Ryan	1000	1415	Taejon		C-27
L-16	#451	Baugh	1300	1435	Impel	Wood	C-27
L-16	#455	Thompson	1300	1512	Patrol	Morton	C-21
L-5	#932	Roush	1430	1555	Taejon	Patient	C-4
L-16	#451	Armstrong	1450	1715	Patrol	Dayton	C-21
L-16	#999	Baugh	1450	1555	Index	Wood	C-27
L-16	#455	Ryan	1520	1625	Munsan	Hightower	C-27
Sun. 8 October 50:							
L-16	#455	Armstrong	0800	0950	Taejon	Dayton	C-27
L-16	#455	Lawrence	1015	1245	Patrol	Morton	C-21
L-16	#458	Thompson	1345	1530	Patrol	Ray	C-21
L-5	#932	Baugh	1535	RON	Miryang-Taegu		C-27

TYPE	A/C NO.	PILOT	OUT	IN	DESTINATION	PASSENGER	MISSION
Mon. 9 October 50:							
L-16	#999	Roush	0630	0925	Taejon		C-27
L-16	#458	Thompson	0715	1755	Kong-Ju	Ivanhoe 6	C-27
L-16	#455	Armstrong	0800	1100	Patrol	Kay	C-21
L-16	#451	Richards	0830	1100	Taejon	Marinick	C-27
L-5	#932	Baugh	RON	0900	Taegu		C-27
L-16	#999	Ryan	1050	1430	Taegu	COL. Ellis	C-27
L-16	#451	Roush	1100	1720	Taegu	Farnom	C-27
L-16	#455	Lawrence	1300	1715	Patrol	Morton	C-21
Tue. 10 October 50:							
L-16	#999	Baugh	0630	0815	Taejon	Morton	C-27
L-16	#451	Armstrong	0800	1035	Patrol-South	Kay	C-21
L-16	#458	Thompson	0900	RON	Suwon		C-27
L-16	#999	Ryan	1300	1345	Patrol Lcl		C-21
L-16	#455	Richards	1300	1505	Patrol-South	Morton	C-21
L-16	#451	Roush	1050	1340	Suwon	Kay	C-27
L-16	#451	Baugh	1545	1800	Suwon	Morton	C-27
Wed. 11 October 50:							
Moved- Chonju to Seoul							
L-5	#932	Baugh	0625	1715	ChonJu-Seoul		C-27
L-16	#455	Lawrence	0700	0840	Seoul		C-27
L-16	#451	Ryan	0700	0820	Seoul		C-27
L-16	#999	Roush	0700	0840	Seoul		C-27
L-16	#458	Roush	1300	1600	Chonju		C-27
Thu. 12 October 50:							
L-16	#999	Ryan	0955	1300	Taejon	Capt. Bailey	C-27
L-16	#458	Hoffman	1315	1710	Taejon	Col. Epley	C-27
L-16	#455	Lawrence	1000	1230	Taejon	Col. Carle	C-27
L-5	#932	Baugh	1400	1755	ChonJu	Col. Tanner	C-27
L-16	#999	Thompson	1355	1800	Taejon	Capt. Bailey	C-27
Fri. 13 October 50:							
L-16	#455	Lawrence	1100	1355	Taejon	Roush (Jaran)	C-27
L-16	#999	Richards	1245	1600	Taejon	Capt. Bailey	C-27
L-5	#932	Baugh	1310	1705	Miryang	Cathcart	C-27
L-16	#451	Ryan	1030	1730	ChonJu-Taejon	Maj. Hoffman	C-27
L-16	#458	Thompson	1530	1730	Taejon	Maj. Rolfe	C-27
Sat. 14 October 50:							
L-16	#999	Richards	1015	1400	Taejon	Capt. Bailey	C-27
L-5	#932	Baugh	1445	1630	Taejon		C-27
L-16	#455	Lawrence	1045	Remain	I Corps	D.S.	C-27
L-16	#451	Ryan	1045	Remain	I Corps	D.S.	C-27
L-16	#455	Lawrence	D.S.		I Corps	Brosnahan	
L-16	#451	Ryan	D.S.		I Corps	Hightower	

	TYPE	A/C NO.	PILOT	OUT	IN	DESTINATION	PASSENGER	TYPE MISSION	
Sun. 15 October 50:									
	L-16	#458	Thompson	1400	1635	Taejon	25 Div Air Sec	C-27	
	L-16	#455	Lawrence	D.S.		I Corps	Brosnahan		
	L-16	#451	Ryan	D.S.		I Corps	Hightower		
Mon. 16 October 50:									
	L-5	#932	Baugh	1315	1415	Miryang	Capt. McGowen	C-27	
	L-16	#999	Roush	1230	1425	Kimpo		C-27	
	L-16	#455	Lawrence	D.S.		I Corps	Brosnahan		
	L-16	#451	Ryan	D.S.		I Corps	Hightower		
Tue. 17 October 50:									
	L-16	#458	Thompson	0940	1245	Kumchon	Col. Holder	C-27	
	L-5	#932	Baugh	1330	1510	Miryang	Capt. McGowen	C-27	
	L-16	#999	Richards	1045	1430	Kumchon	Col. Sloane	C-27	
	L-16	#999	Baxter	0940	1000	Lcl		C-27	
	L-16	#455	Lawrence	D.S.		I Corps	Brosnahan		
	L-16	#451	Ryan	D.S.		I Corps	Hightower		
Wed. 18 October 50:									
	L-5	#932	Roush	1010	1045	Miryang	Capt. McGowen	C-27	
	L-16	#455	Lawrence	D.S.		I Corps	Brosnahan		
	L-16	#451	Ryan	D.S.		I Corps	Hightower		
Thu. 19 October 50:									
			No Flights due to bad weather						
	L-16	#455	Lawrence	D.S.		I Corps	Brosnahan		
	L-16	#451	Ryan	D.S.		I Corps	Hightower		
Fri. 20 October 50:									
			No Flights due to bad weather						
	L-16	#455	Lawrence	D.S.		I Corps	Brosnahan		
	L-16	#451	Ryan	D.S.		I Corps	Hightower		
Sat. 21 October 50:									
			No Flights this date						
	L-16	#455	Lawrence	D.S.		I Corps	Brosnahan		
	L-16	#451	Ryan	D.S.		I Corps	Hightower		
Sun. 22 October 50:									
	L-5	#932	Roush	0930	1000	Lcl		C-24	
	L-5	#932	Roush	1030	1700	Pyeongyang	Col. Epley	C-27	
	L-16	#458	Thompson	1230	1400	Lcl	Maj. Hall	C-27	
	L-16	#455	Lawrence	D.S.		I Corps	Brosnahan		
	L-16	#451	Ryan	D.S.		I Corps	Hightower		

	TYPE	A/C NO.	PILOT	CUT	IN	DESTINATION	PASSENGER	TYPE MISSION
Mon. 23 October 50:								
	L-5	#932	Baugh	0800	1015	Fyongyang	Col. Holden	C-27
	L-16	#999	Roush	1000	1030	Lcl	Lt. Thomson	C-28
	L-16	#455	Lawrence	D.S.		I Corps	Brosnahan	
	L-16	#451	Ryan	D.S.		I Corps	Hightower	
Tue. 24 October 50:								
	L-16	#458	Richards	0845	1100	Sariwon	B/G Bradley	C-27
	L-5	#932	Baugh	1000	1325	Miryang	Capt. Mar.	C-27
	L-16	#999	Hoffman	1050	1645	Fyongyang	Maj. Hall	C-27
	L-16	#455	Lawrence	D.S.		I Corps	Brosnahan	
	L-16	#451	Ryan	D.S.		I Corps	Hightower	
Wed. 25 October 50:								
	L-16	#999	Richards	1000	RON	Anju I Corps	Zadai	C-27
	L-16	#458	Thompson	1000	D.S.	Anju I Corps	Raaen	C-27
	L-5	#932	Roush	0935	1800	Haegu-Fyongyang	Col. Coughlin	C-27
	L-16	#455	Lawrence	D.S.		I Corps	Brosnahan	
	L-16	#451	Ryan	D.S.		I Corps	Hightower	
Thu. 26 October 50:								
	L-5	#932	Baugh	0855	1500	Fyongyang-Sariwon	Maj. Websier	C-27
	L-16	#999	Ryan	RON	1300	Anju I Corps	Hightower	C-27
	L-16	#455	Lawrence	Return from		I Corps by truck		
	L-16	#458	Thompson	D.S.		I Corps	Raaen-Brosnahan	C
	L-16	#451	Richards	D.S.		I Corps	Zadai	
Fri. 27 October 50:								
	L-16	#999	Roush	0900	1630	Lcl		C-27
	L-5	#932	Baugh	1400	1540	Fyongyang	M/Gen Fieser	C-27
	L-16	#458	Thompson	D.S.		I Corps	Raaen	Brosnahan
	L-16	#451	Richards	D.S.		I Corps	Zadai	
Sat. 28 October 50:								
	L-16	#999	Ryan	0900	1040	Lcl		C-27
	L-5	#932	Baugh	0900	1615	Lcl		C-27
	L-17	#029	Roush	Pickup	1725	Taejon		C-27
	L-16	#458	Thompson	D.S.		I Corps	Raaen	Brosnahan
	L-16	#451	Richards	D.S.		I Corps	Zadai	
Sun. 29 October 50:								
	L-16	#999	Ryan			Seoul to Fyongyang		
	L-5	#932	Baugh	1200	1335	Fyongyang		C-27
	L-17	#029	Roush	1155	1445	Fyongyang		C-27
	L-16	#458	Thompson	0855	1005	Fyongyang	Armstrong	C-27
	L-16	#451	Richards	D.S.		I Corps	Raaen	Brosnahan
	L-16	#451	Richards	D.S.		I Corps	Zadai	

	TYPE	A/C NO.	PILOT	CUT	IN	DESTINATION	PASSENGER	TYPE MISSION
Mon. 30 October 50:								
	L-16	#999	Ryan	0900	1620	Anju	Maj. White	C-27
	L-5	#932	Baugh	0900	1605	Anju	Forean Inter- patter	C-27
	L-16	#458	Thompson	D.S.	I Corps	Raaen-Brosnahan		
	L-16	#451	Richards	D.S.	I Corps	adai		
Tue. 31 October 50:								
	L-16	#999	Ryan	0830	0945	Anju	Maj. White	C-27
	L-5	#932	Roush	1015	1635	Haeju	Col. Sinsell	C-27
	L-16	#458	Thompson	D.S.	I Corps	Raaen-Brosnahan		
	L-16	#451	Richards	D.S.	I Corps	adai		

G-4

HEADQUARTERS
2d Infantry Division
APO 248 c/o Postmaster
San Francisco, California

C-4 Historical Narrative Report

Period: 1 September - 30 September 1950

The first of September found the Division disposed along the Nakdong River over approximately a forty-five (45) mile front. Division Headquarters was at Maan-si.

The Division had been consolidating its recent gains in August and was re-organizing and probing the enemy positions west of the Nakdong River.

The night of 31 August - 1 September marked the beginning of the greatest attack to be launched by the North Korean Peoples Army. They crossed the river in hordes at many points and rapidly pushed heavy mortars, artillery, AF guns and tanks across. The enemy's primary objective was Nonsan.

Three enemy Divisions plus elements of several others attacked the 2d Division. This mass of humanity overran the 9th Inf Regt, surrounded elements of the 23d Inf Regt, and then hit the 38th Inf Regt with much less strength.

Extremely large amounts of U.S. equipment were lost, destroyed and damaged through this attack and tremendous amounts of time were expended before, with able assistance of the 1st Marine Brigade, the attack was halted and repulsed. The Division was reorganized at its best ground by the middle of September, reorganized, and about 10 September departed from the defense to the offense. At the end of the month the Division had successfully crossed the Nakdong River and was engaged in pursuit of a stubbornly resisting enemy.

Tremendous quantities of enemy weapons and equipment were overran and captured thus adding to an already increased burden on the supply services. A burden caused principally because of the lack of heavy mortar supporting troops and installations.

The crossing of the Nakdong was a feat in itself in as much as the Division had only 270 feet of M22 bridging and the river was 400 feet wide. By field expedient methods the bridge was literally stretched, approaches built out, and finally developed into a Class II bridge. This bridge became the lifeline of the Division from the middle of September to the end of the period.

The end of September found the Division CP in Chonju on the west coast of Korea. The Division had penetrated the enemy lines, had completely severed his lines of communication to the South, and had reached the Yellow Sea on the west Coast of Korea.

This rapid movement was a tremendous strain on the supply services. As the Division moved forward, the only army supply points available were the original railroads at In-ju (for all Classes except Class V) and the NSP at Puchon (Class V).

The only major assistance given to the Division by Army and/or Corps was 12 Truck Companies. These units were the sole logistical assistance rendered to the Division in its advances to the Yellow Sea. Without them (60th Truck Company, 2 of the 541st Truck Company) it is improbable that supplies could have been kept up with the tactical troops.

It is to be noted that many times the truck companies had over half their strength in trucks assisting tactical units in order to motorize the Infantry and to expedite the advance. Thus supply pipelines were further strained to the limit.

The continually stretching supply line thru the rough mountains, over narrow (and in part one way) mountain roads, the Corps necessitated (because of blown out bridges) taxed supply facilities to the utmost. When the Division arrived at Chonju, it had a supply line of well over 200 miles long, one way, by mountain road from MUMUK - CHANGKONG - CHONG - HONGCHON - KONGKONG - ANGI - CHONGJU - MUMUK. One trip for one truck required over 48 hours and drivers were unable to get much sleep. The trucks received severe beatings from roads and wear and tear but managed to keep going and kept supplies rolling.

Ammunition was the most pressing requirement during the first half of September and it was never in good supply. Army could not keep up with expenditures and it was necessary to allocate ammo; particularly artillery, mortar and carbine ammo. Illuminating shells of all types were in great demand as well as trip flares but neither were available in any but extremely limited quantities.

After the Nakdong River was crossed, the critical supply problems were Class III, with Class III having the greatest importance. Class IV no longer presented problems and units suddenly realized they were overloaded and wanted to turn in parts of their basic load. This was refused and all units were required to maintain a full basic load.

IG's received a problem for evacuation for the first time as they began to arrive in large numbers. Food for IG's was obtained from the counter side as no provisions were authorized for IG's.

The 70th and 60th and 51st Company performed well for several units which is established in the manual. The 70th and 60th did most of the maintenance for the Division and with an extremely competent staff and several programs kept the Division on wheels. Practically no replacement vehicles were obtained during the period. This was accomplished even though a Division and one Company is normally expected to do only 10% of the maintenance work of a Division.

The 2d Company operated railroads, trackheads and over a supply line that stretched in a matter of days from 20 miles to over 200 miles one way. In spite of this difficulty they ended the period with 120 vehicles load, coal to and operational.

The 2d Engineer BN performed notably both as a unit and as Engineers. The normal mission of a Divisional Engineer Battalion was completely overruled as no Corps or Army Engineers were available for back up support. Therefore it was necessary for the Division Engineer Battalion to maintain an ER over 200 miles long, operate a ponton bridge and Class 50 ferry, operate underwater fords, repair an extended ER and render support to the advancing units. In spite of minor breakdowns on some jobs the BN rendered extremely capable support.

All services suffered from lack of supporting installations and troops. Division was forced to take care of itself and fend for itself.

In spite of all handicaps of terrain, lack of support, demands of the tactical situation, the Division trains managed to keep abreast and sometimes in the middle of the tactical troops. Guerrilla activity harassed the supply trains but all but a very few trucks arrived safely at their destinations.

Altogether it was a period of intense activity and covered a period of defense, a period of attack, and a period of pursuit.

During the defense phase, Army supplied three battalion size air drops that aided materially although the first one failed to reach the target on time. The last two were excellent. In addition the Division Milson aircraft were profitably employed to drop supplies to small isolated units caught in the mass attack of the NVA People's Army. Supplies dropped to besieged units included medical, food, water and ammunition.

The lack of medical support had necessitated very long ambulance rides for wounded. It was impractical to send severely wounded men with belly, chest or head wounds to the rear by ambulance. Therefore helicopter evacuation was initiated and proved to be a great success.

It was also possible to evacuate patients from badly isolated positions which the ambulances could not reach. The 1st Marine Brigade made excellent use of its helicopters for this purpose as well as for supplying units in inaccessible terrain.

Organized resistance had practically ceased by the end of the period and the Division was attempting to rebuild its maintenance reserve of Class I, II, and III IV. The weather had become quite cold and winter underwear and sweaters were requisitioned for delivery as soon as possible.

HEADQUARTERS 2D INF DIVISION
APO 248 Q/O FM San Francisco California
A/C of S G-6

HISTORICAL NARRATIVE REPORT

1 - 31 OCTOBER 1950

On 1 Oct the 2d Inf Div, Hq moved into the Chonju area with the three Regiments employed to the North and South of the town mopping up the areas along the KSR. During the entire period, 1 - 31 Oct, the Division was more or less inactive with the mission of mopping up guerillas from Anul - Chonju - Nonsan areas North to Seoul.

Supply lines initially were quite extended, the railhead being still at Miryang, and a truck head at Chonju better than 200 miles away. Considerable strain was experienced from such a long supply line but on 6 October a rail head was established at Chinju for the Division. Considerable difficulties were again experienced when the rail line broke down and trucking was accomplished from Masan a distance of some 400 miles round trip.

On 8th Oct an LST arrived in Kunsan with Class I and III supplies for 2d and 25th Div. 2d Division received 75,000 gallons gasoline and 38,000 "B", "C" and 5-1 rations from this source.

Div Hq moved to vic Seoul on 10 Oct where the immediate needed supplies, Class I and III were readily available and for the first time since about 15 Sept., supply lines were reduced to normal length. The Class II and IV supplies were still critical, and due to shortage of shipping space from Pusan and Miryang very limited amounts of these items were received.

During the period 10 - 25 October units were catching up on much needed 1st and 2d echelon maintenance on all types of equipment, submitting requisitions for combat shortages which had been experienced and acquiring ammunition to complete their basic loads. On 22 Oct a directive was received that the 2d Inf Div would furnish 300 - 2 1/2 ton trucks to haul supplies from Inchon to Pyongyang for I Corps. This was accomplished and continuous trips were made over this route continuing thru 31 October.

On 27 Oct the Div again moved forward to Pyongyang and again supply lines were stretched out to great lengths. Some supplies were at this time being received thru the Port at Masju which was being operated by the Div Q.M.

Due to the continuous operation of the 300 trucks running on the supply route, these trucks originally having been used for long supply runs, a marked increase in breakdowns was experienced during this period and with very few parts available to repair these vehicles. Front springs were chattering and breaking, tires and tubes were in very short supply and anti-freeze was practically non-existent even though the weather was getting quite cold.

1 - 31 OCTOBER 1950
2 - 31 OCTOBER 1950
3 - 31 OCTOBER 1950
4 - 31 OCTOBER 1950
5 - 31 OCTOBER 1950
6 - 31 OCTOBER 1950
7 - 31 OCTOBER 1950
8 - 31 OCTOBER 1950
9 - 31 OCTOBER 1950
10 - 31 OCTOBER 1950

11 - 31 OCTOBER 1950
12 - 31 OCTOBER 1950
13 - 31 OCTOBER 1950
14 - 31 OCTOBER 1950
15 - 31 OCTOBER 1950
16 - 31 OCTOBER 1950
17 - 31 OCTOBER 1950
18 - 31 OCTOBER 1950
19 - 31 OCTOBER 1950
20 - 31 OCTOBER 1950

Quartermaster winter clothing was very slow in arriving to the Seoul area and as yet due to the shortage of transportation has not been brought forward for issue to troops.

8 Incls:

- 1 - Daily G-4 Journal
- 2 - Div Quartermaster Report
- 3 - Div Signal Report
- 4 - Div Chemical Report
- 5 - Div Transportation Report
- 6 - Div Engineer Report
- 7 - Div Ordnance Report
- 8 - Div Surgeon Report

G-4 Journal 2d Inf Div

TELEPHONIC MESSAGES (October)

1 Oct 50

- 0815 1. Hq Moved from ~~Mani~~ ^{Amni} to vic of Chonju, arrived about 1500
- 2015 2. C/S called ref Brockway, leave Brockways and equipment at river for present, Concurrred w/General. Requested road from Amni to Namson to Chonju be given reconn.
- 2030 3. Capt Nelson called and said four trucks from 38th Inf were on hand for POL. Told him to hold tonight and have report to G-4 in morning.
- 2050 4. Talked to Lt Col Berendt and promis.d to give him five trucks to haul signal supplies from Changyong.

2 Oct 50

- 0425 1. Capt Peacock called in ref to location of the 23d Inf Trains.
- 1315 2. Col Sinsel to Maj Frizzle about changing Regt Colors. Also gasoline coming in and when it arrives it will fill the rest of his vehicles.
- 1530 3. Called Maj Frizzelle re ration request for 4491 rations. He stated it was needed as he had so many attachments. He was requested to list his units so as to inform Qi as several units are drawing from him and from own parent units. Call made at request of Div QM.
- 1545 4. Request for gas allowance from QM 72d Tk Bn requested 4000 gallons, 2d Sig 350 gallons - Div arty unlimited. Authorized 350 to 2d Sig and remainder (above 750 gallons) to 72d Tk Bn.
- 1545 5. Capt Tennant (Asst Div Q-) called re procurement of rice for POW's
- 1545 6. Maj Webster to IX Corps. Reported that GI I & III daily train will arrive at Chnju tomorrow morning. Must have Qi personnel to handle. First LST to arrive Kunsan on 4 Oct. approximately 1/2 of load available for 2d Inf Div. See TWX from IX Corps for amounts. 2d Div to advise IX Corps of standing order for 600 tons of supplies to arrive every ten days at Kunsan. Suggested priority gas, rations, and ammo. To notify IX Corps.
- 1615 7. Request for water purification units from 65 RCT forwarded to Major Fry for necessary action to procure same and issue to 65 RCT.
- 1700 8. Msg received from Div ~~Q~~ which had arrived at Chnju. It will close by night-fall. Requested 35 trks which will not be available. Will furnish 15 and move to be made in two shuttles.
- 1710 9. Major Frizzelle called and said a recheck of his ration report revealed some duplicate drawing and that he would check to prevent it in the future.
- 1730 10. 38th Inf wants more gasoline. They have 7 trucks waiting to get it now. Maj Webster to check and see if they are to get anymore.
- 1950 11. Col Sinsel to G-3, tempest advance located here, but no staff as yet.
- 1955 12. Col Sinsel to Maj Fry, concerned road conditions in 19th Inf area. If they are OK for tanks, to call back later.
- 2045 13. Col Sinsel called requesting plane to go to Miryang tomorrow in connection with moving railroad from Miryang to Chonju.
- 2045 14. Called Maj Nabors and informed him that captured weapons were available thru Capt Nelson Hqs Cndt.
- 2110 15. Maj Fry reported on roads from Wonsan to Kongju - no tunnel on road - okay for all types traffic, one bad dip but everything can cross it. Straight W of Knogju across Kum River is a ford that will carry anything we have. Good ford, "C" Co built it. N of Kum river near horseshoe curve there is a road that connects Kum-hung ni to Ferry site. Road doesn't show on map. Ren N to Wolsan Hi not as good as road S of river but will still take anything Div has.
- 2120 16. Called S-4, 23rd re ration request for POW's - 275 -. Informed him no rations were authorized and suggested he turn them in to PWE. He will check in morning and let us know situation.

3 Oct 50

- 0735 1. Col Sinsel called Col Gillian in regards to supply. Capt Slater was sent to Chnju as the representative of the 2d Infantry Division.
- 0737 2. Col Berendt called and has 2 truck loads of wire and wants to know if they could be shipped back to Amni.
- 0743 3. Maj Huffman called DQM in reference to Col Berendt's shipping of wire to Amni if a trip is going to be made.

- 0800 4 Lt Stoner called requesting approximately 3 drums of gasoline for DQM. Request granted.
- 0810 5 Issued yesterday POL - 18 to Hq Co, QM - 21, 23d - 40, 38th - 293, 2d Sig - 13, 82d - 70, 2d Engr - 38, 541st - 1, 72d - 98, Div Arty - 9, 702d - 36, 2d Med - 15, 76th Engr - 18, 37th FA - 12, 2d Field Hqs - 9, MP - 4, (503 - 15, Hq - 3) Bal 10 on hand.
- 0900 6 Call from W/O Sikes, 38th RSO, re furnishing transportation to mobilize one Bn. (Maj Huffman - 25 trucks).
- 0905 7 Mr. Sykes, Impel 4, stated Impel needs 25 trucks at 0630 4 Sept 50.
- 0906 8 Maj Zackerelli on way to Ivanhoe CP
- 0907 9 Col Gilliam on way to Ivanhoe CP.
- 0930 10 Maj Huffman departed for Ivory CP to see Maj Earnshaw re trucks for Impell Movement.
- 1030 11 Last of 5 TC Trk Company Trailers returned from 23d Inf.
- 1035 12 Maj Earnshaw agreed to furnish 13 Trks to Impel CP, 4 Sept 50 at 0730 arrival time at Impel.
- 1125 13 Maj Earnshaw to Col Sinsel told 37th FA Trk blown up. Will have Maj Huffman call back ref transportation.
- 1130 14 Col Sinsel to L₁ vent request for mine sweeping of road North of CP area in connection with ammo trk being blown up.
- 1230 15 Col Grubb called. Wants Col Sinsel to call him. Also Maj Howell to call Cpt Tanner.
- 1315 16 Col Sinsel to Col Grubb re shipment of supplies to Knasan, will check on same with Corps Hqs on visit today.
- 1320 17 Col Sinsel to Maj _____ re moving of bridge out of river bed. Placing under trees.
- 1350 18 QM notified to issue 18 drums POL to 37th BN.
- 1145 19 Maj Zackerly called in reference to the ammo explosion. He states that he will send a mine sweep unit but believes that it will be useless. Also one of his officers was riding 100 yds in the rear when the explosion occurred. He states that the truck was hardly damaged but the trailer was thoroughly demolished. He does not believe that a mine caused the explosion. Maj Zackerly further states that his personnel are not experienced men when it comes to the demolition of hand grenades etc.
- 1445 20 Col Gilliam notified that 72d Tk Bn. collecting together vic Yosan, rations & POL to them.
- 1450 21 Engrs report water points located at Hyopchon, Mansan, Anui, Chinan, Chonju and 1 mobile.
- 1530 22 Issued 150 gals to Hq Co now wants more, have Maj Howell call Sgt Rodden.
- 1540 23 Request for gas by Hq Co disapproved by Maj Howell. QM notified.
- 1600 24 Signal needs 900 gals gas, can get by tonite, will be able to issue some tomorrow.
- 1630 25 Report from QM. 400 gallons gas on hand.
- 1650 26 Major Huffman called Indigo (Col Grubb) asking as to whether they would do the dirt work and greasing for division. Col Grubb stated they would.
- 1830 27 Maj Zackerly called and said the "Navy Cube bridge is at Puyo.
- 1840 28 There is a Ford at Kongju which will handle any traffic as reported by Engrs.
- 1845 29 Capt Nelson got generator from Div Arty, now Hq Co. cant find it, will check with Engrs on 3 DV and let know back.
- 1900 30 24 - 2 1/2 ton trks departed 1530 for Chinju for POL. 3 - 2 1/2 ton dump trks departed 1430 hrs for Chinju via 9th Inf to deliver two loads of Signal Supplies. 14 - 2 1/2 ton from TC trk Co in Ord - 11 more tonite. All to clear by 0800 4 Sept 50.
- 1900 31 Maj Webster contacted 2d Div G-4, 4 Corps G-4, and talked w/Col Ritter G-4 Opns officer of 8th Army. Following info obtained. Rail is now open from Pusan to Waegwan. Waegwan RR bridge still under construction and time of opening expected to be midnight 5 Oct 50. Construction at time of opening expected to be midnight 5 Oct 50. Train run by train from TAEJON to WHEGWAN apparently successful. Trains able to travel as far N as SUWON. Rail terminal at TAEJON needs work before being utilized as a railhead. Road from Miryang to Taejon okay for heavy traffic (tanks and Brockways etc) according to G-4 of I Corps and 24th Div. Army stated that administrative instructions are being issued today, reference new SP. Should arrive tomorrow late. 24th Div G-4 agreed to share cemetery facilities at Taejon. 2d Div QM to contact Capt Berry of 24th Div QM GR Reg section for coordination. Distance Waegwan - Taejon approx 80 Miles. No supply is arriving from Seoul-Inchon area and apparently there will not be any in the early future according to Corps & Army. The 3d TMSIS is now supervising operation of railwayservice.
- 1905 32. Contacted Major Zackerly re condition of Miryang - Taejon road. He stated they should assemble all bridging from Nakdong and move into Miryang. Would try and notify us of trks necessary to haul bridging sometime tomorrow. Plans

- to hold equipment at Miryang until notified by G-4 as to whether to move by rail or road.
- 1910 33 Notified Capt Tennant (Div QM) that G-4 24th Div was agreeable for 2d Div to use the 24th Div Cemetery at Taejon. Also notified him that the Engrs are preparing to take up bridge across Naktong.
- 1940 34 Col Berendt re Capt Ban procuring Sig Supplies, Called army (no action) Some from Pusan) LST to go around to Kusan. Sig supplies at Pusan will put on Supplies.
- 1945 35 18 trks of gasoline arrived from CHINJU. 82d tank waiting to draw. 23d given one more load. 4 for 38th Inf.
- 2000 36 Maj Banner of Div Sig notified b. Maj Howell to pick up 1000 gals gasoline on 4 Oct at QM.
- 2100 37 To FM - OK to put POW's on QM trucks in the morning, remainder to go on ration trucks this afternoon.

4 October 1950

- 0820 1 Div Arty notified they can pick up 1 - 2 1/2 KV generator at Hqs Co., 2d Div. Will send after, will retain ammo on hand, let know later about trks to haul 1200 rds 105, Div Arty can probably furnish.
- 0910 2 Maj Fry in, going to Corps Engr re Engr maint teams, need with us will let G-4 know.
- 0925 3 Capt Grienstaff in badly need of tires, tubes, 750 x 20 - 200 each. Fan belts for GMC 2 1/2 ton, front springs for 2 1/2 ton GMC.
- 1036 4 Col Messinger & C/S in re winter clothing, Col Gilliam was ca led and reported he is going to Chinju tomorrow. Capt Chigolen has reported the clothing being shipped from Miryang to Chinju, will get it here soonest.
- 1055 5 G-3 reported that 65th was pulling its guards off of Ponton bridge Engrs notified, water pt with 65th can be brought fwd to rejoin 2d Inf also.
- 1110 6 Message received from IX Corps instructed Ivanhow to have POW to Kuryan for loading on LST due to arrive evening 4 Oct. Capt English 25th Div Liaison Officer stated LST is standing by at Kusan for the harbor to be swept for mines. He stated possibility of LST landing evening of 4 Oct. 800 PW at Amul now with 9th to be picked up by POL convoy enroute to Chinju the afternoon of the 4th. All remaining PW's to be taken to Kunjan by trucks picking up POL from LST. 25 Div Liaison officer stated the 25th Div has a large civilian prison it is now using as a PW enclosure and could handle our PW's.
- 1125 7 Major Huffman called CIC in re to PO dump.
- 1130 8 Maj Huffman called Col Gilliam at eng. Reported about fuel at POL dump.
- 1158 9 Lt Hendren called states shower unit was located 14 miles up the MSR from here.
- 1400 10 Col Gilliam to Maj Webster reference ration strengths. Air section included in Bn strength. 27 CIC for Hq co for rationing. Maj Webster to call Div Arty.
- 1405 11 Maj Webster to Ivory - 4 (Maj Earnshaw) air section wants 75 rations. (will issue 50 C's).
- 1415 12 Maj Webster to Col Gilliam will issue enough rations (5 in 1) for air section. Will have to support Corps Hqs and troops.
- 1420 13 Maj Webster to W/O Adams re proper method of ration requesting and accounting.
- 1640 14 Col Gilliam to Maj Webster re no rations in Chinju Railhead. LST due in at Kusan today.
- 1700 15 Col Sinsel to G-4 IX Corps re ration section of train being tied up. Dispatched Q1 Officer to Chinju by air to pick up ration convoy in Chinju and meet train.
- 1820 16 82d AAA has enemy ammo. Capt Burma, 702d Qrd Co refused to take enemy ammo and weapons.
- 1825 17 Talked with Lt Col Grubb, M-5 have had two engines burnt ^{due to} lack of Oil and two others due to lack of organization maintenance not head gaskets as stated by Major Earnshaw. Stated 82d AAA has a truck load of US ammo which as been tampered with and is unsafe to handle. Col Grubb reports ammo at Changnyong and across Naktong River has not been touched. Requests instructions on disposition of ammo. Stated 20 trks can do it in 5 to 6 days.
- 1830 18 Talked with Maj Earnshaw and explained Qrd story as above and he will check w/s-4 of 82d AAA. Told Major Earnshaw that Col Grubb would accept any and all enemy material providing normal safety precautions are taken. Major Earnshaw promised to check and explain to AAA.
- 1840 19 Div Q1 called and stated he was going by road to Chinju tonight, leaving immediately to check on ration and POW status.

- 1930 20 Called G-4 at Tempest in re to rations, read the message that was sent to Army in above re also what happened to LST. A liaison plane from 25th Div flew out to sea to try and spot the LST. No ship in sight, the 9th have nothing for breakfast in the morning. Tried to fly an officer to Chinju but bad weather prevented it. A QM officer is enroute to Chinju.
- 1940 21 Called Invent 6 in re to removal of bridge before the ferry. The 65th have a convoy out. The ferry is very slow. The CO of the 65th was notified of the removal of bridge but was not pleased with the removal. The DUKWs have returned to SA on the 28th Sep. One DUKW was left in the mud. The launch has been put into use again.
- 1950 22 Maj Howell returned from recon of Kusan area re arrival of LST due in 5 Oct AM, 25th Div will notify and unload.
- 2050 23 Maj Luthi sent men to Sonngangjin to intercept train and reroute to Chinju. Major Luthi and four men. Reported by S i Goddrell of DQM who came in from Miryang. All QM left Miryang by 1200 hrs today.
- 2100 24 Call Lt Col Sanford (Asst G-4, IX Corps) and told him of above. He stated he had been in communication w/Army and that the daily train for 2d Div left Pusan last night Car Nos: Class I - 154, 4226, 10784, Class III - 846, 752, 4099, 10016, 6439, 27927, 7843. All cars except 27527 are at Masan waiting call forward by us. Corps requested Army to forward pronto. Army to order forward by RTO. 48,000 B rations reserve at Miryang. Requested information from Col Sanford stated Corps was staying out of picture. That they had requested the 3d TRMS to contact them but the 3d TRMS had failed. Lt Col Sanford informed Army that our trucks had been waiting all day and that it was essential to get daily train in damn quick. Army stated that would so instruct the rail service.
- 2125 25 Called Capt Tennant of Div QM on above infor. He will notify 9th Inf by radio. Msg sent to Div Rear at Chinju on above also to be passed to Div QM representatives there. Msg sent to 9th Inf for their info.
- 2210 26 Lt Marohn called in regards to a flight in the morning. Maj Webster said to cancel it.

5 October 1950

- 0710 1. Call to 25th G-4 re arrival of LST, is in contact with Australian Mine Sweeper at 0800, will find out at that time and call back. ASP personnel from Puchon arrived last night, ready to set up new ASP at Kusan.
- 0737 2 Called Invent 6 in regards to trks shipping bridge to Miryang. There are 6 brook loads ammo to be shipped.
- 0745 3 Maj Marshaw in regards to the trks of 105 and msg from Army that Basic load will be carried.
- 0920 4 Maj Marshaw in will have 15 FA Bn pick up 105 ammo from Anui, they are now in that area.
- 0930 5 LST not in sight as yet, some complications have arisen re mine Army personnel and mine sweeper personnel have mtg at 1100 today, will call back outcome.
- 1010 6 S-2, 72d Tkn reports some ammo Japanese in Yosan. 702d Ord notified, PM notified.
- 1035 7 PM called nas 800 PWs here in Chonju, 800 in Anui, 400 have been hauled only in last 2 days from here to Chinju. Maj Huffman notified.
- 1330 8 Call from 25th Div re LST not in sight of Kusan still checking on same, will check on any additional rations the 25th might have and call back.
- 1330 9 There are no communications from Masan to Chinju. Its 4 hrs by truck. A 3-9 car train comes in and has to go back to keep the track clear. Gil sent 10 trks to Masan at 0900 to draw CI I and bring to Chinju. ETA 0500 6 Oct. There are 80 more waiting in Chinju. QM has sent Shegolin to Masan but won't know until this PM what has going to get. Set up for haul is CI I - 16 trks. CI II & IV 12 trks, CI III - 83 trks twice, or 166.
- 1400 10 Call to QM told to acquire 3 day additional rations by 8th Oct in view of contemplated moves in near future.
- 1410 11 C/S was called re flying officer to Army see about getting rations in by plane to Kusan. Said wait until Corps got back from Army.
- 1600 12 3 rear Ech trks (organic) left Chinju for Miryang to bring up Band instruments. Teter wants Nelson's 8 trks back as soon as possible, and wants to know about borrowing 10 or 12 or the 80 now waiting in Chinju. Can do?
- 1620 13 2 - 500 lb bombs in vicinity 3rd Bn., CP (38th Inf) Songdam-MI. 3 Mi S of Yongi.
- 1640 14 Talked with QM at 25th Div stated he had 9 cars of rations at Chinju, would release 20,000 to 2d, msg sent to Col Gilliam at Chinju.
- 1845 15 Wreck between Masan, Chinju cause of delay reported by Col Sanford. Wreck should be cleared sometime tonight. Effective 8 October last trains in Chinju open Erie or Nonsan 9 Oct. No yds in Taejon. Lst out this evening. Tomorrow nite or early next AM 70,000 gal gas probably most of it (boat load) comes to us will let us know.

6 October 1950

- 0620 1 Capt Tennant, Ipana called said 20,000 rations have arrived.
0625 2 Call to Ipana ref POL 9 trk loads of 55 gal drums arrived Ipana.
0835 3 Request from Div Arty S-4 for winter clothing. Sweaters to be in today.
Extra rations to be issued for move.
0845 4 Maj Webster to Indigo (Col Grubb) re DUKW turned in by Ivory 4. Support of
65th RCT to cease. DUKW not in Ordnance.
0850 5 Maj Webster to Ivory 4 (Maj Earnshaw) re DUKW not at Ivory.
0855 6 Call from Lt Edwards (rear) re request for trucks.
0900 7 Maj Webster to Ipana (Capt Tennant) re approval of gas issue to Signal.
0910 8 Maj Howell to 38th RCT.
0915 9 Call from Col Gilliam to Col Sinsel re 6 trucks at Chinju loaded with AG rear
belonging to QM
0920 10 Call from 38th S-4 to Col Sinsel re gas and rations being in. Rat train for
38th Inf left here yesterday. Will draw for 2d Ron Co. Rations issued on
basis of strength returns. QM issued to 38th Inf for 2d Ron Co. 38th Inf did
not include 2d Ron Co. But included in strength of RCT Maj Webster to re-
check with Div QM.
0925 11 Maj Webster to Ipana (Capt Tennant) about Rations for 2d Ron 38 ration slip not
indicating issue to include Ron Co. 82d AAA Btry "C" drew rations separately.
Possibility of 82d drawing double rations. Ron to be issued 5 in 1's by QM
for today.
1110 12 C/S called re American Flags for units, 1 ea Regt, 1 Div Arty & 2 Hqs. QM
notified.
1145 13 Issued 20,000, approx 18000 on hand rations received 40,000. Now breaking down
tomorrow's rations.
1310 14 Call from Maj Becker to Maj Huffman re hauling prisoners, will have to haul
by train.
1915 15 Call from Lt McDonald G-2 to Maj Webster re 800 prisoners to Chinju for ship-
ment by rail truck to Chinju.
1320 16 Maj Webster to Ivory 4, cannot locate flag for Div Arty. Will try to get from
Pusan.
1405 17 Call from C/S to Maj Webster re information on extra rations for Div Arty Move.
1410 18 Maj Webster to Ipana clarifying extra rations for Div Arty (Confirmed LST
bringing more rations and POL. POL report will be called in by Capt Tennant.
1500 19 Call from Capt Tennant, 10,5000 gas - 8,000 left after days issued. No trks
on gas run at present time. 60,000 gals due in on LST.
1530 20 Call from Col Gilliam to Maj Webster - arrangements for JM representative to go
to Pusan.
1830 21 Maj Earnshaw called in behalf of Gen Haynes to thank Col Sinsel for the Rations
and Gasoline.
1830 22 Maj Webster to Col Grubb - 24 tanks to be shipped to Suwan above 11 Oct. Guards
to arrive Pusan 18 Oct.
1845 23 Maj Webster and Col Grubb - 1st Platoon N and of ford by underwater bridge.
76 Vehicles to go yet.
1845 24 Maj Earnshaw wanting to know if ammo over basic load can be turned in for the
82d AAA. Maj Webster informed him that it can if it is over basic load.
1900 25 Pilot reported LST sighted 50 miles down coast from Kusan.
2045 26 Chief Operator called relaying msg from Impel Blue (Lt Wagner) 3.5" Head avail-
able.
2200 27 Col Sinsel called Col Gilliam to concentrate on gasoline. Must get telegram out
to Army for additional gas. Requesting 100,000 gals at Suwan soonest. Make it
a matter of record and Col Sinsel is flying to Army in morning. State in tele-
gram to accomplish future mission of following missions.
2210 38 Called Airstrip in regards for air priority to go to Taegu, to leave around
0630 or 0700.

7 October 1950

- 0650 1 Called Ipana for gas status. Sgt Rodden will call back.
0655 2 140 Drums more gas, 11 drums avn gas on hand at Ipana.
0730 3 QM issued 10 BCT 21 Sep 3,000 lbs bread, 23 Sept 500 lbs bread, 24 Sep 1,367
lbs bread, 28 Sep 500 lbs bread, 30 Sept 90 B rations, 28 Sept 1,375 C, 1,375
5 in 1. Issues to 10 BCT for rations went direct to them.

0810 4 Call from Maj Zachele to Maj Webster reference moving Cat to Suwon on 13 Oct Will be able to move by rail.

0815 5 C.I.L from Col Berendt to Maj Webster request for 30 weight Oil.

0815 6 Maj Webster to Ipana to issue 5 gals 30 Wt Oil to Signal.

0815 7 Maj Friszelle called and wanted to know if he could turn in enemy material.

0830 8 Call fr Maj Earnshaw to Maj Webster. 1st Serial 0600, 8 Oct clear check point #1 0830, Last serial 0830, 8 Oct clear check point #1 Nonsan by 1100. Is coordinated with 38th Inf.

0845 9 Call from Maj Earnshaw to Maj Webster re Ord Evac unit will be ahead at new Army Reserve area.

0900 10 Lt Metro, Div Arty, re requesting 1 ea 2 1/2 ton trk. Will call back.

0915 11 Col Berendt called in re of out of radio set, will be get radio set. One truck in ordnance being repaired.

0920 12 C.I.L from Col Berendt Maj Webster request Info on extra truck add one in for repair.

0940 13 Maj Cunningham has weapons carrier ready for signal.

0940 14 Maj Webster to Sig Off notified of above vehicle. Needs another weapons carrier. Maj Webster will try to procure.

1300 15 Maj Webster to Impel 4 (yellow) Maj Friszelle request for oil for 2d Recon. 38th is out. Rations for 2d Recon (60 C-4's) to help out 38th inf.

1330 16 Maj Webster authorized 40 C rations for the 74th Truck Company.

1410 17 Lt Sowel, QM called wanting to know who was moving today. Informed by Maj Webster that only small units were. Tomorrow I, try, 503d had part of the 38th The remainder of 38th to move on the following day.

1430 18 Maj Brubaker reported that about 30 trk loads of ammo, enemy, was located near OSANG-NI and that a lot of communist came down from the hills every night there.

1535 19 Col Berendt to Maj Webster re moving radio equipment.

1540 20 Maj Webster to Ipana (Capt Tennant) I & III train diverted to NONAN Movmt Of II & IV from Chinju.

1630 21 Col Gilliam called Maj Webster and Maj Webster said that Nonsan train due at Chinju via Nonsan. Only 2000 gals of gas left. 15 to 20 trk loads of rations and gas. Must need room to break out Class II & IV.

1720 22 Maj Webster to Invest, Col Brubaker re Clearance of area for Col Gilliam, Clearance confirmed.

1745 23 Called Col Gilliam and informed him that the place at Sangsan has been cleared with Indst for his use.

1815 24 PM notified to make one way traffic on road North on MSR.

1820 25 Col Berendt to Maj Webster send some signal equip down by trk, but Corps wants to take trk so he wants some transportation.

1950 26 Maj Webster to Indigo, tires got in. But must fill back orders before trk Co. are rationing them out now, but will do the best he can. Have one captured trk at Konju. Maj Webster will arrange for someone to go and pick it up.

2000 27 Maj Webster to Col Berendt stating that the captured trk is at Konju and for him to have it picked up.

2010 28 Col Sinsel to Capt Tennant re rations on hand at Ipana.

2020 29 Maj Huffman to Capt Otiker asking how many trucks he could spare. Capt Otiker to call back later.

8 October 1950

0635 1 Call to Ipana re FOL status

0650 2 Lt Sowl called stating that they have 7,000 gals of gasoline.

0750 3 C.I.L fr Col Berendt re moving to Nonsan of Signal at 0930 (Serial of 16)

0755 4 Maj Webster to Ipana (Col Gilliam) opening at Nonsan, will put out msg to all units. Open new point at Nonsan and close out present pt today.

0835 5 Call from Col Tetler in re to reconnaissance at Suwon. Also 2 bags of mail at Chinju.

0840 6 Col Sinsel called Col Gilliam in re to a couple of bags of mail at Chinju and if he could bring it up forward.

0845 7 Maj Webster called in re to the radio to Chinju was in.

0900 8 Call for Major Webster in regards to drawing rations. Moving of signal equip convoy.

0925 9 Call from Col Berendt msg to be sent by radio to Chinju.

1240 10 Capt Windsband called in re to instructions also if he should deliver the msg to the English forces.

1255 11 Called Capt Carson in regards to Sniper Scope report needed by BUSAK. Give report on serviceable and unserviceable. Will call back.

1300 12 Called QM (Capt Tennant) in re to Hsg and TWX in regards to Class B rations. (operational) Iuthi reported 160,000 gals of gas on hand at Chinju at 1200 hrs 6 Oct - w/40,000 gals on way in on 7 Oct. QM requested this to be shipped fr Chinju to Nonsan. No news from Nonsan as yet.

1315 13 23d Regt to furnish 27 for movement of Index White.

1320 14 Capt Windeband called and was instructed to divert all trains from Taejon to Kunsan.

1330 15 Called 38th Inf S-4 and requested following msg be relayed to Lt Col Sinsel "Q/S requests info possibility of rail movement of 9th Inf. G-3, IX Corps indicates possibility exists. Div Transp Off states approx 70 cars will be needed plus clearance from Taejon to Suwon from 3d TARS. Please inform someone". 38th Inf to acknowledge when msg is delivered.

1400 16 Col Sanford G-4, Corps, called and was informed of the necessity of procuring fr Army a priority for mvt of supply trains from Chinju to Munsan. He is also attempting to put some control on train operating in our area and will attempt to secure 70 cars for Index movement on 13 Oct and box cars for GI I & III from LST at Kmya. Will call back.

1430 17 G-4 IX Corps. (Lt Col Sanford) called and said Army authorized mvt of equipment from Chinju & Masan yesterday. Will give GI III cars highest priority. Will advise later of train for 9th Inf on 13th and train a.d cars for Kunsan. One supposed to start very soon for Kunsan.

1432 18 Capt Utiker (S-4) 23d Inf called and asked name of tom that 23d Inf is to send trucks. Told him to Chokel-re.

1440 19 Capt Larson (S-4, 2d Engrs) reports on Sniperscopes as follows: Total authorized 3.5, On hand 250, Unserviceable to, total serviceable 200-Note: of these 200 serviceable Sniperscopes a probably high percentage cannot be used due to deterioration of batteries.

1510 20 Call fr Capt Huffman to Maj Webster re letter to carry by air to Miryang.

1550 21 Col Stebbins called from Army and promised three trains of gas from Masan would go to Suwon (approx 150,000 gals of gas) Class II will get next priority (winter clothing). 30,000 gals coming into Chonju tomorrow, 40 trk loads (36,000) arriving Chonju today, plus approx 75,000 gals off LST going to Munsan. because he had about 2000 on hand. Info furnished Col Stebbins Army G-4. Capt Stebbins also informed that as a result we had about 300 drums on hand and these would be shipped back from Munsan.

1620 23 Capt Sanford gave Maj Huffman permission to retain 74th Trk Co. He stated that the Index movmt on 13 Oct could be handled.

1810 24 Maj Webster to Sgt Ogle (Ivanhoe 4 Adv) stating that the LST was being unloaded this afternoon and that trains were on hand to take care of the cargo.

1900 25 Scotch called stating that daily train has gone to new location and will arrive tonite. Also our msg 072115 Item will be shipped up North to Suwon as soon as possible.

2100 26 Capt Farnham (2d Engr Bn) re bridging (M4A2) to Taegu. This bridge unit is excess to the T/O&E requirements of 2d Div and ordered us to get this bridge moved. To be shipped to Taegu for 65 Engr Bn. Want plane to take this msg to Miryang. Col Thomas wants Co "A" 76th Engrs to go to Incheon instead of Pusan.

9 October 1950

0630 1 No lines in to Ipana.

0645 2 Call for rations from Capt Platt, 250 replacements at TAEJON. Told to contact G-4 IX Corps.

0700 3 Maj Huffman, to Kunsan, Munsan and Taejon. To arrange transportation for 250 replacements from Taejon to Munsan, to get report on LST unloading at Kunsan, to get report on QM Railhead at Munsan. To expedite daily train from Taejon and to drum up trains for movement of 9th Inf on 13th.

0715 4 Two trains at Taejon ready to roll. G-4 IX Corps stated trains will move out as soon as they have assurance line is clear. Will fly line to notify IX Corps from airfield at Taejon. Drop msg to Qi at Munsan to prevent any mvt of trains beyond Munsan.

0800 5 Capt Farnum - re flight to Miryang to give instructions to Lt Bergner re disposition of excess bridge equipment.

0830 6 Sgt of Engr Section will deliver msg to Co "A", 76th Engrs re move to Incheon instead of Pusan.

0830 7 Msg from Army stating no tanks being held at 30 Ord Co for 2d Div. Notified Col Gabb who will check w/corps ord & checked w/Col Dugan, G-4 of Corps who will call us back.

- 0840 8 Talked with Col Sinsel - Try to get Suwon open as soon as possible. Request all possible trks to Suwon or Osan.
- 0845 9 Lt Col Grubb reported that DUKW was stripped and two wheels removed. Will try to salvage if possible. If not will report to Corps. No answer on tanks from Corps ord officer as yet.
- 0850 10 G-1 requested three trks at 1200 to Div Rear to haul mail to Wonsan and return Trks dispatched from Hqs Co 0915.
- 0920 11 Capt Farnum reports IX Corps wants all M4A2 bridging to be turned over to Corps. Order received from Col Thomas Corps Engr. Gave him information received from pilot who went to Miryang.
- 0930 12 C/S okayed plane for Engrs to go to Miryang to straighten out bridge situation Will be ready at 1030. Notified Maj Fry.
- 0945 13 Msg prepared for Capt Mar instructing him to load everything out of Miryang to Suwon as soon as he could. He is to move out as soon as possible.
- 1000 14 Lt Gilmore called re evacuation of 925 POW's at Chonju and approx 200 at Anui. He has no channel of evacuation at present.
- 1345 15 Lt Stoner (Hqs Co) brought in requisition to procure a new waterpump assy for the 5 KW generator. Engr stated no replacement part available except at Pusan to try and procure pump. If not available Lt Stoner to leave req with Capt Windebank with instructions to expedite.
- 1415 16 C/S cancelled plane due to other requirements. Sent part to Ord for rebuildin. if possible. They will try but it will probably take three days.
- 1445 17 Msg from Maj Huffman re no trains at Wonsan.
- 1515 18 23d Inf called re trk co units attached for move. Told Capt Shoemaker to hold at destination until we contacted them.
- 1520 19 Maj Barnshaw Anyang-ni, halfway between Seoul & Suwon. Maj Fry - river point okay. Will move to new location on 11th and set up water point on water for all of Div Arty. Check with Maj Fry.
- 1600 20 Lt Gilmore POW Ivanhoe Rear #9 has another problem please call.
- 1900 21 Sent msg to Col William - SUSAK is sending daily trains tomorrow to Suwon. Advise sending Railhead section soonest. Please acknowledge.
- 1900 22 Maj Webster called in regards to the evacuation of POW's from Chonju. He gave instructions to Sgt Barone to relay to Lt Gilmore at the PNE that he was arranging for the evacuation of POW's by train. and that he would call him of his progress.
- 1910 23 Sgt Barone called Lt Gilmore at the PNE and notified him of Maj Webster's instructions. Lt Gilmore stated that there are 77 POW's in a Korean Hospital that he is leaving them there until the evacuation is effected. The total POW's that are now in the PNE total over 1,000.

10 October 1950

NO CHANGE

11 October 1950

NO CHANGE

12 October 1950

- 0800 1 37th FA Bn - 1 trailer blown up and destroyed last night. Reported by Maj Barnshaw. 4 incidents: 5 Oct - 1 trlr at Chonju - 37th FA Bn, 7 Oct - Trk and trlr North of Chonju - 37th FA Bn. 10 Oct - 17 trks etc - 38th FA Bn, 11 Oct - 1 trailer - 37th FA Bn.
- 0810 2. Notified Ord who has Capt Carson and several ammo men out checking loading condition of ammo ect. Also will contact Army today for additional technical help if available.
- 0815 3 Lt Col Gordon left to report as technical advisor to Board of Officer investigating explosion of Ammo train of Sv Btry, 38th FA Bn.
- 0840 4. Gen Haynes appointed board to investigate fire (not explosion) in trlr. Trlr was abandoned in vic Chonan. Fire was extinguished. Col Byrs to head board.
- 1110 5 C/I from Maj Gonzales to Maj Webster to daily trains for 10,11,12th, arrivals and if Div will be supplies by 2d or 2d Log Command.
- 1115 6 Maj Howell reported 74th Tpk Det departed for Taejon at 1030. 60 Trks depart 1300 for Wonsan to report to 9th Inf. If 9th Inf gets trains these trks will report to Div rear to move rear forward, also 12 trks loads of Sig Supply to move forward. 38th Inf reportedly left several trk loads of equipment at Chonju.
- 1415 7 Maj Gonzales Scotch 4, called said he has 19000 "B" rations for your Div. At 6th GJ Group at Yongdong'g. Due to other commitments cannot outload it. Is desired that you send Div Trains to pick them up. At same time bring Daily Telegram for following day to Col Simpson same place. This information was give to Col Sinsel two days ago.
- 1430 8 Gen Haynes visited G-4 to confer w/col Sinsel.

- 1620 9 Start drawing from Yongdongpo on 13th for CI I SP. CI III from ASCOM city 5 miles West of Yongdongpo.
 1640 10 C/S approved 10% spot check by Ord Teams.
 1650 11 8076 HDB Army Surg Hosp will arrive Suwon 13 Oct 50.
 1800 12 Col Grubb notified to be here tomorrow at 0930 on tanks in 2d Division
 2000 13 Sgt Myles, Signal, wants to know when trucks will be available for Sig Supplies. Would like them at 1000 - 7 trucks enough. Capt Barr needs 7 trucks at above 1000 hrs at Suwon. To Incheon for Signal Supplies.

13 October 1950

- 0740 1 Call to Maj Cunningham re men to escort new tanks (Delivery cancelled).
 0820 2 7 Tpts laid on with Capt Otker from 23 Inf for DSSO to haul wire from Incheon.
 0830 3 G-3 in with TWK from EUSAK states usually reliable sources indicated possibility of enemy air activity 13 Oct. Passed to G4, Sig, Ord, Cml, Trans.
 0845 4 Maj Huffman to Col Grays re embargo on trains. Informed there are no restrictions.
 0910 5 Maj Earnshaw on trucks for M-5 tractors, informed him DDO is working on it. S-4 is sending report on ammo status of Arty units. Report on 503d M-5 tractors which Lt Col Grubb reported at Chonju as having burnt out motors due to lack of oil.
 0930 6 Contact Capt Otker or Lt Hendren of Service Co for representative to guide team to units. To inspect and repair (if possible) sniperscopes and snoperscopes of the 23d Inf Regt.
 0930 7 Ord, QM arrived for conference with Col Sinsal.
 0935 8 Maj Earnshaw called re establishment of showers unit vic Anyang-NI told him it was ordered established yesterday for use of troops in that vicinity. Wanted to know what to do with WP on hand and was told to hold it until tomorrow and then return to H & S Co. of 2d Engrs.
 1040 9 Call from Capt Schoglin to Army re getting winter clothing. Request 1st priority from Pusan.
 1045 10 Col Gilliam called Army requesting Army take over operation of Miryang Cemetery. Army will take over cemetery. Also talked about procurement of Non-Farrif size shoes.
 1100 11 Maj Webster to Maj Cunningham re Flag pole for Div Hqs. 3 prong pole for UN, Korean and US Flag.
 1105 12 Call fr Maj Luthi - drawing of rations by B Co., 519 MP. Army has QM CP at Yongdongpo. Army will find out and call Ivanhoe 4.
 1150 13 Maj Roth (Armed Advisor) IX Corps arrived for discussion of tank status report.
 1410 14 Maj Webster to Maj Luthi re not leaving B Co 519 MP, draw rations at Div QM (Ath A Order) wanted fresh meat, trying to get double rations.
 1450 15 Maj Cunningham called stating 38th FA wanted priority on vehicle maintenance, was told first come, first served.
 1450 16 Maj Webster called to QM asking if 10 BCT had been issued any rations. It Seoul will call back.
 1800 17 Maj Howell to Maj Luthi when train arrives w/9th Inf put an interpreter and send to Anni-NI.
 1945 18 Call from SA to Maj Webster thought we were shifting railhead and was informed DQM will remain in Suwon.
 2000 19 Call from Col Sloan to Maj Webster re moving 9th RCT. Everything loaded and would like to use trucks set up by Maj Howell and is very well pleased with the arrangements made.

14 October 1950

- 0745 1 Maj Huffman called Ipana 6 re arrival of 9th Inf trains. Will call back.
 0800 2 Maj Morehead stated 4 cars had been sent to Suwon from Yongdong-po Train 960 on the way from Taejon will be stopped at Suwon. QM notified.
 1020 3 Maj Howell to Ipana (Capt Tennant) re size 14 shoes, will try to purchase locally.
 1325 4 Maj Howell to Index (yellow) fastest on trains, 3 consolidated into 2 first in from Taijon 1400, 2d due in 1700, at Suwon. 1 hr run after that.

- 1330 5 Capt Walker, 23rd, called for repair team for sniperscopes and snooper-scopes. Will send out.
- 1335 6 Maj Howell to Invent 6 Capt Farnum to send out repair team for 23rd on Sniperscopes and Snooper-scopes.
- 1520 7 Capt Schoelin reported, he states GI I & III will be shipped daily from Yong-dong-po by Army to Suwon. Critical shortages of oil and subs at present time. Also S-4 Div Arty and S-4, 9th Inf reported in stating special service supplies were issued today.
- 1525 8 Maj Howell to Igana about Bath units for 82d AA will find out location and call back.
- 1530 9 Maj Howell to Ivory - 4 shower unit attached to 82d AA trains will revert to Div Arty Control.
- 1535 10 Maj Howell to Scotch, request use of 500 rds 105mm for training Inf off in fire adjustment. Scotch 4 will call back (Col Tracy).
- 1540 11 Maj Howell to 23rd requesting location of bath unit.
- 1555 12 Call from 60th Trk Co, re trucks moving Rear Echelon, will return as soon as they arrive.
- 1605 13 Maj Howell to Maj Luthi re bath unit at 82d AA to be used by all personnel at Div Arty in the area. (Proposed laundry schedule) doing in at ang-yong. Can do 1500 pieces per day. Units notified.
- 1750 14 Capt Mar called and reported that the first train of 9th Inf is in Suwon.
- 1755 15 Lines out to 9th Inf, So Major Howell called Div Arty 4 requesting that they send a messenger to 9th Inf stating that the first train of the 9th Inf has arrived in Suwon and will be arriving at anyong in approximately 1 hour.
- 1805 16 Major Gives of 8th A G-4, stated Co C.O. to report to KMAO Hqs in Seoul not later than 0800 morning 17th October.
- 1930 17 Div Arty stated 9th Inf received Msg re trains going to ang ang-ni 1655. Msg received by Mr. Howe.
- 2000 18 Col Sinsel to Maj Earnshaw in regards to reassignment of vehicles 1 ea 2 1/2 ton available for reassignment at Army. Request for extra ammo has been approved by Army. Maj Earnshaw to bring recommendations in tomorrow.
- 2110 19 Capt Marr called stated he needs 4 more trucks to haul personnel. Maj Webster called Col Gilliam and he is sending 4 down to Capt Mar at railhead.
- 2230 20 Col Jones called Maj Howell in regards to ammo for training purposes stated that Army would not authorize any at this time for training.

15 Oct 50

- 0800 1 S-4, 23rd Inf re Mr Holland Asst 4 with 5 rail cars in Taegu started Miryang on 10th. Rail is overcrowded, he should be in within next few days, I Corps has had priority but should release within next few days.
- 0810 2 IX Corps notified G-4 at 2230 hrs, 14th that as of 0001 hrs 15 Oct, 2d Div came under Army Control.
- 0815 3 9th Infantry reported that elements from 2 trains closed in area 2330 14 October 1950.
- 0900 4 Col Sinsel to Div QM requesting decals for MP vehicles and helmets. Col Gilliam will call back. 38th Inf requested Regimental colors and Guidons be replaced. Col Sinsel wants date of request to QM. Requisitioned by unit 14 September forwarded to Army 15 September 1950.
- 1025 5 Capt Carson wanted to know where Class V ASP was located.
- 1030 6 Call from Col Winter, SA, to Maj Webster re arrival of tanks, should be enroute from Pusan.
- 1306 7 Maj Gilliam is coming up in the morning to find a new location.
- 1545 8 Maj Earnshaw to Col Sinsel in regards to turn in of excess ammo due to shortage of trucks.
- 2114 9 Col Sinsel called with Col Silbert in re to tanks crossing the Han River.
- 2115 10 Maj Webster called Maj Luthi in regards to trucks of a 503d Tanks. Give priority to Index. Are moving sooner than was expected. Maj Huffman talked with Maj Luthi in regards to a truck being returned to the 8046. Truck was abandoned in the 702d Ord area. No job order with the truck (undetermined). It is believed to belong to the 19th Inf. Markings on bumper are 8046. Maj Luthi will call later.
- 2120 11 Maj Cunningham called in re to abandoned truck. Truck was definitely abandoned. It had a bent frame, broken clutch housing and bent Trk rod. Damaged beyond the scope of Div Ord. Should advise Corps.

16 Oct 50

- 0810 1 Call to Col Gilliam re arrival of winter clothing... 3 carloads of Cl II & IV in. 2 cars of rations in for 2d, 4 cars of gas in, will get one or more.
- 0820 2 HQ notified to procure an American Flag size of UN & SK flag of cotton material (G-4 will pay) will try to get. Found that Hqs Comdt has required flag.
- 0830 3 Maj Schwartz in re Bridge platoon of 2d Engrs, delivered Bridge to I corps. They ordered personnel to remain with bridge. Check on TWX states bridge platoon of 65 BCB to pick up equipment from Ivanhoe.
- 0850 4 Call to 72d Tk Bn re Tk dozers, 2 on hand both unoperative, 23rd.
- 0900 5 4 cars POL, 2 cars rations received in Suwon last night.
- 1210 6 Call to Army S-4 re 2d Div bridge platoon. Personnel and Brockways will stay with I Corps. C/S notified.
- 1215 7 Engrs report 5 KU generator has been repaired for Hqs co.
- 1315 8 Call 2d GM re PX rations last week for Air Section, supposedly issued to Hqs Co, they did not receive. Go down and pick up.
- 1325 9 Call from Bomb disposal at Army will be down within next few days to assist in destroying duds from arty fire. Ord off notified.
- 1400 10 Call to Col Gilliam re move going East of Inchon open all class of supply there on Wed 0800, 18 Oct (Old Marine Bakery Area). 0700 this AM - 6 POL - 40,000 2 Class I 18,000 3 cars class II & IV. 1400 this PM - 2 Class I - 18,000. Reported to Col Davis.
- 1450 11 Col Grubb states trucks on M-5 vehicles (503d) have over 300 miles wear left except for 3 which are being replaced.
- 1700 12 Capt Mar called and Signal cars from Chonju are in at Suwon.
- 1900 13 Requested Lt Col Gilliam to hold 1500 C rations and 5000 gals of gas in reserve for immediate use. Continue priority to 9th Inf.
- 1915 14 Called Div Ord (Capt Jamison) re tank tracks for 9th Inf. Requested to expedite replacement as fast as possible and give G-4 a reading tomorrow noon of estimated life left in trucks still in place. Two with narrow tracks are being replaced. Seven are having rubber tracks replaced w/steel tracks. One finished tomorrow. Rest of rubber tracks serviceable for 500 miles. 38th Inf Tk Co has 60% life still left. 23d Trk Co is in worst shape.
- 2114 15 Col Sinsel called in regards to the tanks that crossed the Naktong.
- 2115 16 Maj Webster called Maj Luthi - repairing the tracks of 503d tanks. Give priority to Index. Maj Huffman talked with Maj Luthi in regards to a truck being returned to the 8046. One truck abandoned in the 702d Ord area. No job order with the truck. The motor was frozen. It is believed to belong to the 19th Inf. Markings on bumper are 8046. Major Luthi will call later.
- 2120 17 Maj Luthi called Maj Huffman regarding trucks. Truck was abandoned. It had a bent frame and bumper broken clutch housing and bent fork. Should advise Corps. Damage beyond this scope.
- 2130 18 Col Sinsel called with Col Seibert in re to tanks crossing the Han River.

17 Oct 50

- 0705 1 Call by Maj Huffman to Maj Kuhns, 9th Inf re required transportation to move 9th Infantry (60) trucks.
- 0800 2 Maj Earnshaw to Maj Webster requesting ammo. Told to draw from Ascom City.
- 0820 3 Called Lt Sowl (DCM) who stated that GI will continue to issue Class I & III from Suwon today. Plenty of gas and rations on hand now. Reserved gas and rations for T F Foster.
- 0930 4 Notified 72 Tk Bn to have 5 gas trks ready to roll plus 1 or more ammo trks for support of T F Foster. Msg sent to 72d Tk Bn via Tk Bn Ln Off.
- 1015 5 Major Earnshaw called requesting information as to replacements for M5 tractors of 503d FA Bn. Col J.J. Karnes 8th Army Arty, informed Gen Haynes that sufficient tanks were available to completely fill shortages of 4 for 503d FA Battalion.
- 1030 6 Maj Gonzales at BUSAK and Lt Col Jones at BUSAK 4 section re availability of M-5 tractors. Jones will investigate and call back as soon as possible.

- 1035 7 Capt Windler of 2d Recon Co called re 70 B rations for feeding T F Foster. Told him we would call X Corps and authorize same.
- 1040 8 Talked to Div Ord to check on M-5's. Stated tracks were available for two on hand and that they were waiting for 503d FA Bn to come and turn same. Ref shortage of 4, the DOO will call Army.
- 1045 9 Informed Maj Barnshaw of above contacts and information.
- 1055 10 Called Lt Sowl re rations for TF Foster. Told save 70 rations for 2d Recon Co. for additional personnel.
- 1110 11 Maj Koeber - re TF Indianhead supplies. Gave him information of where to draw supplies and get ammo and food.
- 1125 12 Maj Webster to Ipana task force Indianhead to pick up 5 trk loads of gasoline and 1200 rations, plus 1 drum of oil.
- 1130 13 Maj Webster to Indianhead, 5 gas trucks furnished from 72d Trk Bn. Maj Koeber will pick up.
- 1140 14 Maj Webster to 38th Inf (Capt Lowry) 11 - 2½ tons to accompany company only 8 came. will check and call back.
- 1145 15 Call from Koeber to Maj Webster only need one more track and rations needed.
- 1245 16 Call by Maj Webster to Indianhead re arrival of truck, should be there in 20 minutes.
- 1250 17 Call from 9th Infantry to Maj Webster re 25 2½ tons for 9th Inf.
- 1445 18 Maj Howell to Div Arty re basic loads of ammo. Training among units overages and shortages to bring up to basic loads.
- 1515 19 Major Huffman called Capt Baker of Div Arty will send 20 trks tonight. Capt Otiker of 23rd will send 19 trucks to index tonight. Capt Lowry will send 25 trucks to Index Sv Co tonight.
- 1540 20 Capt Otiker called and wanted to know if the baggage car has come in yet.
- 1545 21 ColKels Army Transportation Section stated he would issue the necessary instruction to RTO at Yondong-po to spot all Ivanhoe cars at Gryudong instead of Ascom City.
- 2120 22 Call from 8th Army to Col Sinsel 2124 cases of beer in Ascom City.
- 2125 23 Col Sinsel called Maj Luthi for Ipana to pick beer up.

18 Oct 50

- 0710 1 Col Sinsel to Col Messinger - vehicles of one Regiment in another Regiment, is reported, some vehicles are abandoned.
- 0730 2 Maj Huffman departed CP to supervise motor movement of 9th RCT.
- 0910 3 C/S called re 2 2½ ton trucks of military police which were traded by 23d Inf. Requests 1st priority to these trucks by Ordnance. Ordnance notified.
- 1110 4 Call to Ordnance Officer re report on shortage of vehicles and to what units, will turn same in this P.M.
- 1330 5 Major Frizzelle, General Bradley there this A.M. States desire for all personnel to have decales for all helmet liners. PI officer notified to order.
- 1530 6 Call from Major Luthi to Col Sinsel re no Russian tires available.
- 1800 7 38th Infantry re decales. G-4 is attempting to get them as soon as possible. Will have more information tomorrow.

19 Oct 50

- 0700 1 Capt Mar called Maj Huffman. Wants Maj Huffman to call him.
- 0730 2 RTO called 4 carloads Ord, 2 Sig in from Suwon and Miryang, tech agencies notified.
- 0750 3 Call to CM re squad tents for 38th Inf, being issued today, need 2 boxes mimeo paper for MO, will call back.
- 0940 4 Call from Div Arty to Maj Howell concerning certificates covering burials losses and requisitions covering same.
- 0945 5 2 ea Bullet Proof vests sent to 38th Inf for trial by drivers and Comdt request Co
- 1715 6 Contents of incoming trans reported by Mr Maron. 27 ¼ ton trucks, 12 - 2½ ton Cargo, 3 2½ ton Dump, 18 3/4 ton, 32 water trailers. Mr Maron with train w/12 M4 tanks.

2200 7 Maj Webster conversed with DQM - Everything except woolen underwear. Try to borrow off 3d Log Cnd. 9th Inf to draw tomorrow morning. Everybody to get pile jackets instead of Ike Jacket if CG approves. Pile Jackets best. Slougher from DQM to display equip and explain if CG desires. Units are trying to draw stuff which will make immobile. Beer-6 cans per man 2 can per man for 3 days. Handled on roster. Trousers, flannel shirts for everybody. Recommend issue wool trousers field trousers cotton, pile jacket, sweater (already issued). Wool gloves insert wool - Shells - A ration tomorrow. Day after tomorrow Mr Slougher Note praise by arty. Only div to get beer. Discovered oil dump - SAE 30 in short supply - In dump 30 & 50. Estimated 35,000 gallons. Food Items: Salt - Army plenty coming in. Coffee - 435,000 rations over issued. Conserve for awhile. PX Rations - 50 in 1 pack stationery inside must be distributed for all men. 50 packs of cig only, chewing gum etc. Can get limited supply of cots if wanted. But units must remain mobile can issue up to officer strength of div. Get decision Paper for PIO - Tomorrow from 3d Log Cnd. 11 tents to 38th QI Co from QM Co T/OS&E teatage.

20 Oct 50

0715 1 adv Party for CP move to depart 0900. 1 Jeep, 1 trailer, 1 off & 2 EM.
 0830 2 30 1/2 ton, 17 3/4-21 volts, 12 ~ 2 1/2, 32 water trailers, 4-2 1/2 ton Dumps, 12 tanks on way, as reported b. Ord. Wants breakdown. Fill all units to TD and E on water trailers. 1 to air Section (leaves 5) Dumps 4 to Engr issue 16 3/4 ton as short. 1 to Sig. issue ton RCW 3 Hq Co - 10, 9th Inf 7, 23d 3, 38th 2, Div Arty 2, Retain 3, in Ord. Breakdown of 13 tks, 9th 2, 72d A - 4, D-4, C-3, Breakdown of 2 1/2 ton - 1-38, 11-38 FA Bn.
 0900 3 TO QM issue Pile Jacket to units, get hands on all teatage possible but don't issue.
 0915 4 G-4 to EUSA&K G-4 supposed to have 13 tanks enroute, please check and let us know. Lt from 24th Div tk Co in to pick up 5 M4A3 tanks.
 1100 5 Col Jones called from Scotch stating tanks had not departed from Fuson due to shortage of flat cars. Have 91 loads awaiting cars.
 1105 6 AG re purchase of uniforms for officers specifically ARO personnel, issue same and turn in prior to departure from theater.
 1310 7 Div QM requesting air lift for 33 tons better be rail priority shipment, trans. OFF acting on spec. Col. Gilliam checked with Arty QI will issue suit of winter underwear from A&S&C GITE this PM.
 1745 8 Col Gilliam states will issue rations tonight "A" to the 23d. Also winter underwear, same for 37th, 82d In & 2d Engr Bn, units notified by G-4 to pick up.
 1805 9 Col Sinsel called Maj Becker in regards to the 8075 Mob Surg Clearance at 0400 tomorrow to go to Sinnach. M's will escort them through town. Will pick them up at 0500 at the traffic signal and will escort them thru Seoul.
 1810 10 Maj Huffman called Scotch (Transportation Officer) for assignment of Truck Co for movement of Div to new Assembly area (TO, 8A will Call).
 1815 11 Maj Huffman called Maj Stewart in regards to movement of the RCT. Maj Huffman will call later.
 1825 12 Maj Huffman called Ivory 4 in regards to the above telephonic messages. Gen Haynes to Col Sinsel in regards to abuse of vehicles, addibility of tractors. Col Sinsel promised to call the artillery tomorrow and get all information on track vehicles and is to call the general after obtaining that information.
 1910 13 Trucks to report to 23d Inf 10 ea from 72d Tk 20 ea from Div Arty 30 from 38th 23d to send guide to 38th Inf.
 2220 14 Capt Larson Invent #6 called in regards to C-4 rations for B Co, 2d Engr wanted 163 for move tomorrow. Called DQM and arranged for rations as per Major Howell instructions. Capt Larson is to pick up rations tonight.

21 Oct 50

- 0745 1 Call to Div QM re issue of winter clothing and rations.
0945 2 Div move cancelled due to lack of logistical support. 9th & 23d RCT's have moved.
1015 3 PH called Col Sinsel reference move called off and tonnage to be carried over 50 ton bridge.
1020 4 Col Gilliam requested units to notified to draw winter underwear.
1030 5 Call to 2d Engrs re decals for 2d Div to be procured locally. Still attempting
6 Call to (red) re issue of winter underwear etc. Wait then all notified again to pick up same.
1150 7 G-4 representative returned from I corps with information as to supply for 23rd RCT, possibly 9th RCT later.
1400 8 G-4 to Div QM regarding supplying 23d and 9th Inf. 155 mi to Sarwon, 1 way. Take 50 trks (25 per day) to supply one RCT or 80 (40 per day) for RCT's (2). This will give us a slight build up.
1430 9 G-4 to Army G-4 re supplying 23rd and 9th Inf in Sariwon. Need assurance of 30,000 gal gasoline per day for div for date only scattered amounts rec'd can assure 30,000 gal/day (Col Davis).
1435 10 G-4 to Army Trans Co., as to availability of trucks Co's need one to help supply our personnel in Sariwon area, will check and call back.
1530 11 G-4 to Army G-4 re 8076 Evac Hospital move today, should retain sufficient transp to support themself.
1550 12 Col Sinsel to DQM requesting personnel to accompany 20 trucks loads of supplies to be issued to forward units. (Part A & Part Res) left to Q. for decision on rations, all on QM trucks.
1555 13 Call to Inform to draw 2 days extra rations.
1620 14 Call by Col Sinsel to Col Davis at 8th A regards availability of gasoline.
1640 15 Call for SA, Col Matten, G-4 to Col Sinsel reference support of Hospital moving up with assignment made w/Army Surg and Div Surg, 8076 transportation to be used to move tks Hosp. on return trip. 8076 will retain enough transp to supply themselves.
1915 16 Col Sinsel to Scotch 404 in regards to gasoline 30,000 gal for 1 RCT. 9th RCT not included if 9th is included will have to have more. 2400 gal to make turn around, and for small build up. Gas decided to supply patrol elements of 23rd Inf. Recon groups and 1 RCT on patrol. Red Ball turn around which will take two days. 100 gals for 2 1/2 trk on turn around estimate.
2000 17 Capt Wendebank to deliver Gen Sgdan by 1300 tomorrow. Cleaned shined and in tip top shape by order of col Sinsel.
2100 18 Hosp 8964 to move out with 24th Inf. 8076 to remain in Surawon. Information received from Div Surg.
2115 19 Call from G-4 SA in regards to gasoline for troop movement promise 30,000 gal a day for movement all taken by Col Sinsel.
1920 20 Col Sinsel to 2d QM in regards to the 30,000 gals gas to be picked up every day QM has priority on this pickup 30,000 gal promised by Army notify that 8076 Hosp will be located at Surawon.

22 Oct 50

- 0800 1 Call from Col Davis, SA for Col Sinsel: QM on 600 drums of ROL, mostly Mo gas.
0815 2 WO Teckner called stating a priifer in Seoul woul furnish sample of Decal today, if occupied price would be 50 Won or 2¢ each.
0830 3 Maj Earnshaw to Maj Huffman in regards to trucks. Maj Earnshaw was asked to furnish 20 trks for Red Ball express. Stated that he could. Maj Lowell to Maj Earnshaw regards to ammo: Excess ammo to be turned in to ASP Auth: Mag CG EUSAK.
0910 4 Call to Engrs re generator of Div rear, is it possible to repair, will check further today.
0915 5 Call to Div QM re gasoline, Col Davis EUSAK G-4, Supply assures us we can draw 600 drums, 30,000 gal/day for 2d Div.

- 0945 6 Call to Ivanhoe advance re 23d Inf trucks returning. 55 each have supplies for them, should be on way back, 20 returning. 300 to be furnished I Corps from 2d Div. 9th Inf setting up 75. 225 from remainder of Div.
- 1st 1st Gp of 50 - Ascom City for rations, next 100 to Yongdong do for gasoline, next report to 4 Corps G-4 representative at Pyongyang for disposition. 2 driver per truck, 1 off for 25 trucks. 300 trucks forwarded this afternoon will inform you on above call from PM to Col Sinsel.
- 1330 7 Div QM notified to send some Class A rations to 9th Inf also beer ration.
- 1340 8 Col Stebbins G-4 BUSAK notified that 50 trucks would be at ASCOM CITY by 1600 to transport Class I supplies next 50 trucks out also this PM to transport POL, other 100 - to each (class I & Class III) out early in AM. Col Sinsel wants 25 or 30 trks put on the road to come back here to load. They have 45 on the road. They are to furnish 75 total. Trucks need to support I corps, total of 50 from 23d for their own support 25 for their own support to be sent immediately.
- 1400 9 Div Arty called re trucks for transp personnel to Bob Hope Show. SF SO off will be contacted by G-4.
- 1430 10 Call from BUSAK can set up rail head at Munsan-Ni if desire will check and call back.
- 1459 11 23d to get their trks rolling, 45 on way should be 25 later to be sent direct. 180 trks to be loaded today at 1600 other 75 will be out tomorrow. Recn & Hqs pers just arrived. We will have 2d Recn priority over Sabre, on movement.
- 1900 12 5 trks QM ROK depot vic Seoul RR Sta for rations. 30 Cl I ASCOM CITY 40 POL Incheon City.
- 2130 13 Div Arty can furnish only 25 trks leaving 0715, 23 Oct, called by Maj Earnshaw to capt Windebank. 3/4 tons will be used to take troops to Special Service show at Seoul 1100 hours 23 Oct.

23 Oct 50

- 0800 1 Maj Earnshaw report 30 trucks departed for North 0715 (2 Off in charge) 50 went out at 1515 yesterday.
- 0815 2 Capt Hounds reports 20 trks from the Bn will depart for Incheon for POL 0900
- 0820 3 Capt Larson reports 5 trks departed for ROK QM depot vic Seoul RR Station to haul ROK rations to G-4 I corps.
- 0825 4 Capt Lowery reported 25 trks will report to ASCOM CITY for rations for G-4 I corps at 1300 hrs or sooner.
- 0935 5 Maj Earnshaw re radios on jeep turned in to Div Hq. Want to turn in mosquito nets and head nets, will let know later, mosquito nets and head nets to be handled 50 to bundle, turned in any time.
- 1435 6 Call from Officer incharge of check point, regards to truck convoys. Check point to be through today, 12 only checker through without officers in charge.
- 1630 7 Call to 2d Engr re repair of Lights and heating system in Bldgs occupied by 2d Div. Can pay for labor, will get more info and call back.
- 1900 8 Call from Maj Luthie near Pyongyang about winter clothing, PX rations for 9th 5 trucks up tomorrow with some of above items not full PX ration, I corps supposed to draw for them.
- 1910 9 Call from Adv, G-4 representative told 28,000 gal gas, 1-B, 1-A ration up today for 23d & Recn, 13,000 gal gas and 5 trucks woolen clothing, PX rations etc for 9th. Phone will be there for Gen Bradley provided weather is OK, jeep for Eichnor cancelled.
- 2200 10 Message conveyed to Maj Luthie inclosed with this Journal.

24 Oct 50

- 0835 1 Lt Hawkins with 3 trucks went to Miryang 4 days ago. Someone to Fly down
Get equipment moving.
- 0905 2 Replacements to be sent out 190 - 9th Inf, 153 - 23rd Inf setting up trans
for these personnel with call AG back.
- 0930 3 Call to Div QM re stoves and tents of units of Div.
- 0940 4 Col Sinsel cleared plane trip to Miryang for Capt Mar as expeditor for rail
shipments.
- 1020 5 Call to Div Ord re support for 3d RCT. Will check on basing them with unit,
that area or moving 19th Ord forward. Let G-4 know later.
- 1250 6 Call to Engrs re purchase of electricity fuel, put into use turn axes etc,
will have answer after conference this PM.
- 1410 7 Maj Earnshaw called for Col Sinsel request that Col Sinsel call him back.
- 1415 8 Disp Motor Pool Called, 8 trks to QM Rep Depot, had just been dispatched.
- 1550 9 Capt Smitheron of 2d Reprn Co res 8 trks to replacement Co at Sarawon to
get rations to take along.
- 10 Capt Mar's report on rail cars at Miryang.
14 Box Cars - 23d 5 box cars
Ivanhoe Rear 1
9th = 7 box cars
Signal 1
- 7 Heavy flats
1 light flat (2½)
Loaded Flats
D-4 537; 1 Lumber 2321; 1 assault boat 2469 and 1 barbed wire 4156.

25 Oct 50

- 0745 1 Call to Div Ord re Ord support for 23rd Inf. Can send platoon there, Ord
Co, as large contact team, after decision is made.
- 0855 2 Maj Howell called Col Gilliam: 9th RCT will revert to our control short-
ly. When time comes, the 9th will have to support themselves. However,
they will need supply to Pyongang at this time. Strength of units on
TF Indian head:
GIC - 14, 38th - 155, 72d - 44, 2d Ren - 50, 2d Engrs - 15, 82d - 16,
Med - 3, Total - 297.
- 0100 3 Call from S-4, 23d in regards to tentage. Informed that tentage should be
requisition through regular channels, QM is in for 1300 squad tents and
stoves, will probably take several weeks.
- 1400 4 23rd Inf has drawn some prestone, have appx 300 gal left. Issued 4400
gal so far 4000 still coming probably today. 19th Ord Co to Sariwan to-
morrow, take 2 days rations with them.
- 1530 5 Col Cassidy called, support as much of 2d Div fr Haeju as possible, other-
wise from Pyongyong. Barge in at 0600 at Haeju. Passed to Div QM.
- 1715 6 Col Cassidy at Scotch4 called in regards 90 EM Jackson is using at the
airstrip says they are doing a good job and he would like to continue to
use them.
- 1900 7 Maj Huffman called Col Miles at Army and requested T.C. people to operate
R.R. from Haeju to Sariwan. Request granted. People to report to Col
Gilliam on 26 Oct 1950.
- 2015 8 Call from Col Davis Scotch 404 Line out.
- 2030 9 Intelligence summary of Haeju. Port Finished DQM
- 2045 10 Col Sinsel called Maj Ganyobs, 8 A, requesting call to Col Davis asking check
on message from Col Davis.
- 2100 11 Message cleared: Col Davis wanted to call to Index.

26 Oct 50

- 0750 1 Maj Howell to Col Grubb, 19 Ord Main to move today.
- 0815 2 Call from Maj Earnshaw to Col Sinsel told class I & II will still be oper-
ated from Yongdung-po. Some winter clothing being shipped north by truck
by QM. Div Arty to send up Reserve for distribution of officers lockers.
90% complete on antifreeze to 30 degrees below zero. 4000 more gallons due
in today to make 100% to 30 degrees. 19th Ord Co to move north for
div support tomorrow.

- 0830 3 Col Widder called and 2d Inf Div will operate supply lift to 1 Corps, and furnish info on Haegu port facilities.
- 0900 4 Call to 2d QM, Sig personnel at Ivanhoe advance now composed of 72 personnel to be subtracted from strength here.
- 1335 5 Call from Maj Ray re anti-freeze, for 9th Inf, same will be sent forward tomorrow by 19th Ord Co to Sariwon can be picked up there. Tires and tubes are critical even has trailers on blocks now to operate trucks. Ord Off notified to send anti freeze forward.
- 1400 6 Call to Army G-4 states plenty of tires in Japan, low priority on shipment told trailers jacked up, will check into it.
- 1425 7 Call to Army G-4 re arms and equipment with ROK soldiers when they leave the 2d Div. Take up bag sleeping Matn and OD-7 Field coat issue wool sleeping bag.
- 1630 8 Ipana notified 19th Ord moving north for support.
- 1700 9 9th and 187 RCT to be supported by air lift. 600 tons on trail at Haegu port. Call from Chief of Staff.
- 1830 10 Col Widder, G-4 Army, called and wants 50 trk loads of rations at Kaesong to be handled to Pyongyang. Trks to report to WD Ludamity at Class 1 Dump. Col Widder stated a Post Co is on the way to Chinan-go to open the port. It will be 10 days more.
- 1900 11 Capt Schoglin has 15 trks to go north early tomorrow, 6,00 A Rations, 6,500 C rations 4025 5 in 1 rations, will be sent to Haegu unless directed different by Col Sinsel (Ordered to Sariwon).
- 1945 12 14 Trk loads of rations left 0500 this date for Haegu with Col Gilliam. 10 trks II & IV; 3 trks loads I, to Sariwon. Scheduled out 0600 tomorrow; 15 trk loads CI I to Sariwon, 15 trk loads CI III to Sariwon.

27 Oct 50

- 0830 1 Call to Ord Off re anti-freeze for 2d Sig 100 issued, 66 gal still due will issue on arrival.
- 0935 2 Col Harpo Army Trans re unloading of 7 barges at Haegu, when will be completed when railroad in operation. Msg sent this a.m. will call back when answered.
- 1010 3 Band is requesting issue of OD wool trousers and shirts, will be issued 1300 today. Lt Peterson notified.
- 1130 4 Sect DAO, Sect Supply & 2d remain to support troops in this area. Capt Searcy in charge, front springs critical, QM only has 4 on requisition so better get in for the 11, will give them priority. QM notified.
- 1400 5 Col Grubb in, moving 702d (-) forward on Sunday, going forward tomorrow contact Webster see above going in vicinity Pyongyang. Leaving here 1 Maint. Plat, 3-DAO personnel and few supply personnel. Making arrangements to draw supplies in this area from 60th Ord Gp for these units remaining here.
- 1800 6 Maj Webster to Col Sinsel: Barges very small, 5 unloaded. LST is present. Lt Col Spear in charge (Cmd Craft) (3d Log (Cmd Craft) keep Class I at Yongdongpo. 1 & 3 must be maintained at this area. Div arty will have control except for opns. New port can handle 1000 tons per day if equipped w/crews. Class A & B rations not being kept up by Capt Schoglin. (He has been notified) Maj Luthi to draw from this area by truck daily. 6000 28th Oct, 6000 5 in 1 & CSs and gas. Collect truck for 9th, 25 trks 1 Off in charge and instruct what to land and where. 1 convoy to Maj Luthi. 23d has 3 convoys on road now. Everything to go thru Maj Luthi for clearance. SA to give instruction where and what to load on empties not to move any trucks otherwise. 10 trains per day each way when they started. D.M. recommends stoves and tentage be shipped by water to Haegu from Pusan. Col Sinsel desires QM representatives use own judgment.

28 Oct 50

- 1015 1 CG I Corps requested 300 trucks from 2d Inf Divs
 1st 50 CI I - Ascom City, 2d 50 CI III - Yongdongpo,
 3rd 50 CI III - Yongdongpo, 4th 50 CI I - Ascom City.
 25 trks from last increment to come from 23d Inf. Trucks to have 2 drivers per truck and 1 Off per 25 trucks. Note: loading to proceed to Pyongyang and report to G-4 Section I Corps there. CG I Corps approved above. 2d Division to be immobilized and also 1st Cav. No missions. 23d Inf authorized only 2 & 3/4 ton patrols.

- 1305 2 Tell Major Webster or Major Schwartz to fulfill his mission. Must have an additional 25 trucks from the 23rd. This will make a total of 75 trks. Put on road to his soonest. Call Col Sinsel.
- 1355 3 100 loading this evening. 50 at Mascom City & 50 at Yongdongpo. Load at 1600. Col Stebbins notified. Total of 215 will be enroute by tomorrow. 3 empty trks will arrive G-4 from 23d tomorrow evening. 9th will provide direct.

29 Oct 50

- 0700 1 W/C called regarding message to 702 Ord. W/C is unable to contact 702 Ord.
- 0930 2 Maj Webster requesting winter clothing for two war correspondents for trip to Yalu River (187 RCT) will call back.
- 0940 3 Call from Index 4 issue "A" rations at air head. Will issue if someone will set up central drawing agency.
- 1110 4 Maj Webster to Maj Luthi requesting him to relay the following msg to Maj Stewart (23rd Inf) to send the two convoys of 25 trucks to Aesong to pick up 50 trk loads and bring to Kongyang. Also for Maj Luthi to check in and out all 2d Div convoys going through his area. Also to notify Col Gilliam to come and see Col Sinsel. "A" rations to be drawn from Maj Luthi.
- 5 All messages & Trk requirements for Army come through 8 Army G-4 at Pyongyang to G-4 2d Div. Per telephone conversation of Lt Col Davis. Request a report by 2400 re winter clothing in hands of troops.
- 1315 6 Col Sinsel called Maj Seward at Inspire asked him if he brought up 50 trks from Insong. 2 Convoys in or coming into Aesong. There are 50 trks out now.
- 1320 7 Col Sinsel called Scotch 604, Maj Biggers, in reference to the Div boundary. G-3 had copy of the fragmentary order put out by USAK (To Col Davis) How long will we have to support these units? If we take over this additional area, will have to put two battalions there.
- 1330 8 Call for Maj Webster from Maj Luthi in reference to 25 trks left from Stewart and 25 more to Sariwon. Maj Webster asked about the empty drums. As soon as Maj Luthi gets ours he's to load, these drums. North Koreans will be paid in North Korean Currency.
- 1500 9 Call from G-5 requesting water point for PWE by 0800, 30 Oct.
- 1510 10 Maj Luthi relayed message from Col Gilliam requesting No of indigenous enemy laborers in 9th Inf and 2d Recon. Total figures only for report of USAK.

30 Oct 50

- 0825 1 50 trucks to Aesong today, some 100 tons of ammo from Sariwon to Haeju as collected but not transported to Taeju as yet, will get answer from Army and let you know. LST in last mile.
- 0840 2 Call to Army G-4 re captured equipment collect in Haeju, ship out to destination of incoming boats.
- 0845 3 Called Maj Luthi (Sariwon) reference ration receipt.
- 0910 4 Call from 9th Inf re Signal supplies still back in Yongdongpo area, should send back for requirements.
- 1120 5 Div Engr in told to move H & S D Co. Invd vic Pyongyang soonest, also study and establish water pts as required throughout this area. Div Ord Off in moving south edge of Pyongyang, set up assembly line there to service trucks on I Corps Commitment.
- 1245 6 Major Huffman & Maj Howell call Invent. Call to Col Sinsel, 30 trucks going to 9th Inf to assist in move to Chinampo this P.M.
- 1400 7 CO, 19th Ord Co in, has to send maint section back to Aesong to help clean up maintenance of vehicles there, possibly take 1 week. Will look into possibility of moving vic Sinwon-ri or in between 3 Bns of 23rd Infantry and make recommendations.
- 1410 8 Call from 2d Recon, drew 143 rations today, someone in G-4 gave that figure to 9th Inf. Check with G-1 shows strength as 147 plus 67, (8 on DS) 9th Inf notified.
- 1800 9 Maj Huffman called Major Luthi for data on possible loads at Sariwon. No loads as yet.
- 2010 10 Call by G-4 to 9th Inf CO re Med Clear Pl. t. Recommend not be split, not his intent will leave as is.
- 2015 11 Lt Montague - Asst S-4 of 187 RCT called requesting ammo to complete basic load. Cleared with Army G-4 to draw at airport and or ASP 16.
- 2045 12 Maj Webster called Maj Luthi - 1 truck, beer for 9th Inf, 85 to 90 cases.

4 trucks of rations. 5 trucks to depart early in the morning Col Sinsel talked with Maj Cunningham in reference to ordnance section at truck ops center. Put on ordnance team there tomorrow morning early. Trucks being on call and wanting direct support. 44th rd moved yesterday and it is understood that they have some parts. No tires, no tubes. Capt Windevank needs on the spot support.

- 2235 13 Col Davis (Scotch Advance 604) requests 50 of Capt Windevank's trucks be at Munsan-ni at 0900 hrs 1 Nov 50 to move personnel and equipment of 10th BCT. Requested Major Webster to notify Capt Windevank

31 Oct 50

- 0800 1. Call from Maj Luthi - Has 20 Truck loads supplies to pick up. 4 truck loads "C" Rations. 4 Truck loads Signal Equipment. 12 Truck loads 5 in 1. Signal Equipment marked for 24th Inf Request transfer be sent soonest. If trucks are not all 6x6's will require 25 trucks.
- 0820 2. Capt Worden of "K" Co., 38th Inf wants clean HBT's (for Maj Webster).
- 0830 3. Notified Capt Worden to send truck back to 38th Inf for purpose of obtaining clean HBT's, new clothing, beer, mail, etc.
- 0920 4. Destination of 10 BCT - Anju, assigned to I Corps Col Davis states I Corps being notified to receive them. approximately 2400 1 Nov., release our trucks immediately.
- 0930 5. Col Sloan to Col Sinsel in regards to Helmet liners, 1000, for ROK Police Col Sinsel is to try to get them from Army.
- 1300 6. Gravy 4 called concerning authorization of tentage for 187th RCT. Major Howell to check and call back.
- 1305 7. Maj Howell to Scotch Adv, 604 (Col Davis) requesting information as to authorization of tentage for 187th RCT. Col Davis to call back.
- 1610 8. Major Kuhns water point for Bn at Chinnampo. Water point will be in tomorrow night Maj Webster.
- 1855 9. Mr Harol of the CIC called in re to the Flags that Maj Howell requested. He said that he tried to get in contact with Maj Young but they have no phone connected at the present time. However he is working in trying to get the Flags and will keep Maj Howell informed of his progress.
- 2100 10. Lt Price (AngrBn) will report to Maj Huffman for temporary duty on 1 Nov 50
- 2100 11. Col Carle will have a Medical Officer report to Vanhoes Security Force Hqs at 1000 hrs (Vicinity of City Hall). He will check at City Hall by 0900 hours tomorrow to Col Coughlin.
- 2130 12. Lt Col Davis (EUSAK G-4 Section) okayed issue of 1 additional B&L C to 9th RCT tonight. Major Kuhns notified.

Cnl Sect

HEADQUARTERS
2d INFANTRY DIVISION
APO 248

1 October 1950

HISTORICAL REPORT, DIVISION CHEMICAL SECTION

1. During the month of September, 1950, the Division Chemical Officer maintained his office with the Division Command Post (Forward) and the enlisted personnel under the direct command of the Assistant Division Chemical Officer remained attached to the 702d Ordnance Maintenance Company.

a. On 1 September, the Division Chemical Officer and the Division Chemical Section continued in location in the vicinity of SONGDONG-NI.

b. On 13 September, the Division Chemical Section closed vicinity SONGDONG-NI and opened 7 miles North of CHANGYONG.

c. On 19 September, the Division Chemical Officer accompanied the CP, which closed vicinity SONGDONG-NI and opened vicinity T'ONGCH'ON-NI, 2 miles South CHANGYONG.

d. On 24 September, the Division Chemical Office closed vicinity T'ONGCH'ON-NI, and opened vicinity CH'UNGGE, on the Hwang River.

e. On 27 September, the Division Chemical Section closed vicinity CHANGYONG and opened 4 miles West of KOCHEANG.

f. On 28 September, the Division Chemical Office closed vicinity CH'UNGGE and opened 1 mile West of ANUI.

2. On 15 September 1950, JASPER C. WELLS appointed Warrant Officer, Junior grade. Oath administered by Division Chemical Officer at the Adjutant General's Office located at Division Command Post, Rear, in MIRYANG. Warrant Officer WELLS assigned to duty with the 702d Ordnance Maintenance Company.

3. On 7 September 1950, Lt COLHOWARD P. MCCORMICK, Chemical Officer, EJSAX, telephoned the Division Chemical Officer to briefly discuss policy matters.

4. During the period, the Chemical Officer submitted reports to the Division Assistant C/S G-3 on the subjects: Coca-cola bottle concussion grenade, Russian N-50 type 15 pound wooden mine, demolition kit, and Japanese civilian defense gas mask.

Historical Report, Division Chemical Section, September 1950.

5. On 13 & 14 September, demonstrations were made for personnel of each of the Infantry Regiments in a method of improvising an explosive incendiary from an AN-M14 incendiary grenade.

6. On 5 & 8 September, Chemical Section personnel made trips (one each day) to PUSAN to the Pusan Logistical Command for the purpose of expediting the flow of Class V supply to ASP#4, which serves the Division. As a result of conference between the Chemical Officer, PLC, and the Division Chemical Officer on 5 September, the flow of chemical materiel and supplies was improved.

7. During the period, 49 portable flame throwers were modified from the M2-2 type to the M2A1 type by the Division Chemical Section. An additional 22 M2A1 type flame throwers were received from PLC together with 12 additional M2-2 type flame throwers. The Division is now completely equipped with authorized standard flame throwers or substitute limited standard type (12 of the latter). A shortage, not critical, exists in certain auxiliary flame thrower equipment.

a. Maintenance, filling and pressuring of 33 flame throwers was performed for divisional units and for units of the 1st Provisional Marine Brigade during the period.

b. Salvage of one air compressor (7 cubic feet per minute) by battle field recovery was made.

c. Division Chemical Section personnel prepared 280 gallons of thickened fuel (Napalm, 46).

8. During the period 4 to 20 September, 1840 M15 white phosphorus grenades were issued to troops through ASP#4.

9. Lessons learned.

a. The Division entered into combat with an unsatisfactory Class V ammunition supply procedure. By trial and error, a satisfactory arrangement was obtained.

b. In any situation calling for the intensive use of flame throwers (Class IV materiel), the Division Chemical Section is entirely inadequate in personnel and facilities to properly accomplish its mission. A suggested solution would be the attachment of a Chemical Service Platoon of two (2) officers and perhaps thirty (30) men to augment the T/O staff, together with necessary equipment. Experience has shown that combat units cannot or will not perform any echelon of maintenance on the flame thrower.

Richard O. Gordon
RICHARD O. GORDON
Lt Col Col C
Div Cml O

HEADQUARTERS
3d INFANTRY DIVISION
APO 243

1 November 1950

HISTORICAL REVIEW, DIVISION CHEMICAL SECTION

1. During the month of October, 1950, the Division Chemical Officer maintained his office with the Division Command Post (Forward Echelon) and the enlisted personnel under the direct command of the Assistant Division Chemical Officer remained attached to the 70th Ordnance Maintenance Company.

2. The Division Chemical Officer moved on the dates: (1) 1 October, closed KUI, opened CHUNJU; (2) 3 October, closed CHUNJU, opened KUNSAN; (3) 11 October, closed KUNSAN, 17 October, opened vicinity SECHU; (4) 27 October, closed vicinity SECHU, opened vicinity P'YONGYANG.

3. The Division Chemical Section moved on the dates: (1) 2 October, closed vicinity KUCHANG, opened CHUNJU; (2) 13 October, closed CHUNJU, opened vicinity SINCHONG-NI; (3) 29 October, closed vicinity SINCHONG-NI, 30 October, opened vicinity P'YONGYANG.

4. 1st Lieutenant ROBERT W. KAPP promoted to temporary grade of captain effective 27 September 1950. Notification of this promotion received on 5 October.

5. During the month the Division Chemical Officer investigated and reported on: (1) a asbestos mine, the mine of the oil, vicinity airport, opened near SINCHONG on 12 October; (2) the KYONGP'IC IRON WORKS COMPANY (iron and steel plant and steel works), KYONGP'IC, on 30 October; (3) the KIM IL SUNG ELECTROCHEMICAL LABORATORY, vicinity P'YONGYANG, on 31 October.

6. Portable flame thrower instructions was conducted for the 1st Battalion, 3rd Infantry on 17 October and for the 2d & 3d Battalions, 3d Infantry on 18 October. Operation of the mechanized flame thrower demonstrated to the Tank Company, 3rd Infantry on 22 October.

7. On 7 October, excess Class II chemical equipment consisting of 37 each apparatus, including 11, 21 prepared for shipment to 3d Logistic Command. This item turned in at 3d Logistic Command (Ascom City). On 21 October, excess Class IV chemical equipment

Historical Report, Division Chemical Section, October 1950

consisting of:

- 7 each, flame thrower, portable, M2-2
- 19 each, flame thrower, portable, M2A1
- 1 each, kit, service, mechanized flame thrower
- 2 each, kit, service, portable flame thrower
- 3 each, kit, fuel filling, for portable flame thrower

turned in at Ad Logistic Command.

6. During October, the Division Chemical Section filled and pressured a total of 24 portable flame throwers and filled and pressured the mechanized flame thrower with five fillings. For this, 380 gallons of thickened flame thrower fuel (napalm) were prepared.

7. The Division Chemical Officer served as a technical witness, Board of Investigation of ammunition fire and explosions on 17 October.

8. Nothing new in operational experience is noted during this period, and no lessons of significance other than those already noted were learned.

Richard O. Gordon

RICHARD O. GORDON
Lt Col Col C
Div Chl C

Ord Sect

HEADQUARTERS
2D INFANTRY DIVISION
DIVISION ORDNANCE OFFICE
APO 848

CSHIS-5
4 Oct 1950

COMMAND AND UNIT HISTORICAL REPORT
(CSHIS-5)

Period of Report - 1 Sep 1950 - 30 Sep 1950.

1. Unit - Special Staff - Ordnance Section.
2. Mission - The mission of the Ordnance Special Staff Section, 2d Infantry Division is as follows:
 - a. Advise and make recommendations to the Commanding General and Staff on all matters as pertain Ordnance, both technical and tactical.
 - b. Preparation and execution of Ordnance Plans.
 - c. Supervise Ordnance Field Maintenance Activities.
 - d. Provide information on the characteristics, capabilities and limitations of Ordnance equipment, and ordnance ammunition.
 - e. Determine requirements, initiate procurement action, and supervise the distribution and storage of ordnance general supplies and ordnance ammunition.
 - f. Investigate and make recommendations, on instances of improper supply economy and any abuse of ordnance equipment and ordnance ammunition.
 - g. Investigate and make recommendations on mechanical and safety engineering matters as affects ordnance equipment and ordnance ammunition.
3. Organizational Statistical data.
 - a. No organizational changes within Special Staff Section during period.
 - b. Roster of Officers, duties (See Incl 1)
 - c. Breakdown of operation (See Incl 2)
 - d. Daily Journal of activities (See Incl 3)

COMMAND AND UNIT HISTORICAL REPORT (Cont'd)

4. Principal problems encountered.

a. Due to lack of sufficient Tank Recovery equipment, approximately twenty two track vehicles were not recovered. Of these abandoned vehicles five were known to be combat loss and through cannibalization a large percentage of the remaining seventeen could have been put in serviceable condition. The complete lack of Army Ordnance Maintenance support, until the last two weeks of the period covered by this report, aggravated this problem.

b. Ammunition supply has been a major problem during this entire operation. Due to long supply lines, shortages of several types of fast moving items, lack of ASP operating personnel and required transportation, this Division established three Division Ammunition Supply points. Upon rapid move of the Division forward, it was necessary to turn these ASP's over to other than Divisional units due to lack of operating personnel and necessary transportation to displace these ASP's forward.

5. Miscellaneous:

a. The over-all value of utilizing well-organized and equipped contact teams has been thoroughly proven. Due largely to their on-the-spot repairs and instructions to gun crews, a total of only five (5) 105mm Howitzers and two (2) 155mm Howitzers were evacuated to Ordnance Field Shops during the six week period of heavy firing. Most of these could have been repaired on the battery sites, however in order to avoid loss of the guns for several hours, replacement was made when the job was estimated as requiring more than four (4) hours. Contact teams were also responsible for immediate return to service of numerous Armored and General Purpose vehicles which could otherwise have been evacuated with resultant loss of perhaps several days of operation.

b. The need for increase of organic Division Ordnance to a size capable of full support in combat, or at least the attachment for operational control of an Ordnance Medium Maintenance Company, has become more apparent as a result of this operation. When a Division moves at a rapid rate, as is more or less normal in modern tactics, the delay occasioned by the necessity of clearing a movement of the additional company through several Headquarters renders the company fairly useless to the immediate needs of the Division.

c. The need for sufficient organic ordnance troops for full support is further illustrated by the fact that the organic company, while designed for "approximately 80% of supply (less ammunition) and maintenance support of the Division in combat, was called upon during current operations for:

COMBAT AND UNIT HISTORICAL REPORT (Cont'd)

- (1) Full supply and maintenance support of the Division
- (2) Extensive location and evacuation of captured enemy materiel.
- (3) Transportation of ammunition and operation of three forward ammunition dumps for the Division.
- (4) Evacuation and repair of unserviceable ordnance equipment abandoned along the MSR by rapidly moving Division units under ordinary circumstances this could be accomplished by Army Ordnance Units.

d. The urgent requirements for, and indispensability of, the M-35, Tank retriever has been thoroughly proven. In the type of terrain encountered in the Korean Theatre, this type vehicle should be issued in lieu of the heavier and cumbersome Tank Transporter.

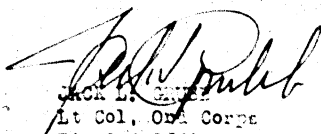
Jack L. Grier
Lt Col, Ordnance Corps
Dir Ordn Officer

3 Incls.

1. Roster of Officers and unit assignments
2. Breakdown of operations
3. Daily Journal of activities.

HEADQUARTERS
2D INFANTRY DIVISION
DIVISION ORDNANCE OFFICE
APO 248

BREAKDOWN OF OPERATIONS

The following is a breakdown of operations during period
1 Sep - 30 Sep 1950.

1. SUPPLY:

a. Requests for parts and secondary assemblies totaling 9750 line items has been received during period, of which 73% or 7117 have been filled immediately.

b. Twenty-five G.P. vehicles issued of which 5 were rebuilt from battle field recovery.

c. Twelve G Combat vehicles issued of which 7 were rebuilt from battlefield recovery.

d. Approximately 3000 items of small arms issued of which 1500 were rebuilt from battlefield recovery.

e. Four artillery pieces reclaimed and issued on a direct exchange basis.

2. MAINTENANCE:

a. Work Order processed:

G.P. Vehicles	429
Combat Vehicles	141
Small Arms	3138
Instruments	435
Artillery	21

Note: The above Job order figures do not reflect a true picture inasmuch as the bulk of the small arms and artillery jobs and a large percentage of automotive jobs are done by Ordnance Contact Teams within the using units area and are not accomplished on Job Order.

3. AMMUNITION:

a. Transportation request processed	457
b. Total tonnage	3812
c. Number of rounds by type:	

155MM GUN, M2	
155MM - Steel, Illum., M118	652 rds
40MM AA Gun	
PTWJ-B- Cart., AP-T	3266 rds
155HV- Cart., HE-T	12386 rds

MEMORANDUM OF OPERATION (Cont'd)

90MM GUN, M2 & M3

SECRET

P88M-H - Proj., AFC-T 650 rds.
 P88V-U - Shell, HE, M71 w/PDF 4000 rds
 M71M-S
 P88M- Shot, M71M-T 360 rds

57MM RIFLE

R13F- Shell, HE-A1 M300 190 rds
 R13K- Cart., HE, M300 1450 rds
 R13A- Cart., Smoke, M3, M300 600 rds

76MM M2

R26H- Proj., AFC-T, w/c Fuse 700 rds
 R18C- Shell, HE, SC, M71 1400 rds
 R18C- Shell, Smoke, M7 300 rds

76MM RIFLE

R18F- Cart., HE-A1 600 rds
 R18K- Cart., HE, w/PDF 1400 rds
 R18A- Cart., Smoke, M7 300 rds

76MM GUN

R18H-H - Proj., AFC-T, M71 600 rds
 R18H-K - Shell, HE, w/PDF 4000 rds
 R18H- Shell, Smoke, M7 1400 rds
 R18C- Shot, M71M-T 700 rds

105MM HOW., M2A

R14J- Shell, HE-A1 1900 rds
 R14S- Shell, HE, w/PDF 7350 rds
 R14V- Shell, HE, w/PDF & Smoke 38340 rds
 R14C- Shell, HE, w/TSQ 7350 rds
 R14W- Shell, HE, w/TSQ
 and S. Chg 900 rds
 R14J- Shell, HE, w/c Fuse, w/
 sup. chg 1300 rds
 R14J- Shell, Smoke, M3 80 rds
 R14C- Shell, Smoke, M7 1700 rds

160MM HOW.

R26A- Charge, Proj., M3 (S) 694 rds
 R26M-C- Charge, Proj., M3 (M) 700 rds
 R26L-G- Shell, HE, M107, w/
 sup. chg 10100 rds
 R26Z- Shell, Smoke, M3 14 rds
 R26B- Shell, Smoke, M1 211 rds
 R26Y- Shell, Smoke, Yellow 11 rds

BREAKDOWN OF OPERATION (Cont'd)

FUZES AND PRIMERS:

R3F1- Fuze, PD, M51A4	8204 rds
R3F1- Fuze, TSQ, M54	408 rds
R3F4- Fuze, TSQ, M58A1-A3	4472 rds
R3E3-D- Fuze, Time, Meck, M57A1-A3	220 rds
R3F3- Fuze, V2, M58 (TSQ)	1402 rds
R3FV- Fuze, V2, M57 (TSQ)	4892 rds
R3E1- Primer, percussion, M52A1	1114 rds

60MM MORTAR

R3C1-L- Shell, HE, M49	24886 rds
R3C2-B- Shell, Ill., M49	1646 rds
R3C3-B- Shell, Smoke, M49	100 rds

81MM MORTAR

Shell, HE, M49, w/PT, M50	11100 rds
R3F1- Shell, HE, M50, w/TSQ, M50	5441 rds
R3F2- Shell, HE, M50, w/TSQ, M50	4170 rds
R3F3- Shell, Smoke, M50	1010 rds

4.2" CHEM. MORTAR

R3M1- Shell, HE	2000 rds
R3M2- Shell, Smoke, M1	104 rds

LAND MINE

M5A1-C- Mine, AT, M5	80 rds
R3E1-B - Mine, AP, M5	140 rds
R3A5-B-C- Mine, AT, M5, M5	1000 rds
M5A5-B-C- Mine, AT, M5, M5	200 rds

DEMOLITION MATERIAL

M5E1- Block, Demo, M5, M1 (Chin)	40 rds
R3M1-C- Block, Demo, M5 (Block)	200 rds
R3M2- Block, Demo, M5 (Block)	100 rds
R3M3- Cap, Blasting, Electric	1000 rds
R3L3-J-Cap, Blasting, Non- Electric	1000 rds
R3M4- Charge, Charges, Demo (C.A.)	80 rds
R3M5- Cord, Detonating (M5)	1000 rds
R3M6- Detonator, M5-Sec. delay	200 rds
R3M7- Cord, M5, L Block	100 rds
R3M8- Fuzing Device, M5, Detonator, M5	400 rds

ARMORY OF OPERATION (Cont'd)

E7KS-	Firing Dev., Ball- M1	250 rds
R7KT-	Firing Dev., Release M1	400 rds
E7ER-	Fuze, Blasting, Time	4000 rds
E7KC-	Lighter, Fuse	1000 rds
E7FA-	Mit, Bangalore, Torpedo	
	MLAL	10 rds
	Mine, Chu	700 rds

HAND GRENADES

S43I-L-	Fragmentation	4000 rds
S4K-	Offensive	1100 rds
S43C	Fuze, M1400 & M100	1000 rds

RIFLE GRENADES

S4VE-	AT M1001	1000 rds
S4VI-	Smoke, M1	300 rds
S43C-O	Adapter, M1	1000 rds

FLARES

S51C-	Trl, Parachute M1	300 rds
-------	-------------------	---------

SIGNAL CODES

S6RI-	Amber Star Cluster	100 rds
S6FO-	Amber Star Parachute	100 rds
S6IF-	Green Star Cluster	70 rds
S6IQ-	Green Star Parachute	100 rds
S6IC-	Red Star Cluster	100 rds
S6II-	Red Star Parachute	100 rds
S6IL-	White Star Cluster	100 rds
S6IS-	White Star Parachute	100 rds

ROCKETS

S9AK-	2.36" HE-M1	1000 rds
S9AM-	Smoke, M1, 2.36"	270 rds
S9AK-	HE-M1, 2.36"	1000 rds

CANNON AMMUNITION

T1CA-	Cart., Ball, Caliber	100000 rds
T1CC-	Cart., Tracer, Caliber	100000 rds

CANNON C.L. .30

T1ED-	AP in ctn	20000 rds
T1EL-	AP in 2 rd clips	80000 rds
T1ED-	AP M1 Belted	190000 rds
T1EW-	Ball in Ctns	31000 rds
T1EM-	Ball in 2 rd clips	100000 rds
T1ET-	Tracer in Ctns	10000 rds

CANNON C.L. .50

T1LA-	AP M1 Belted	10000 rds
-------	--------------	-----------

MISCELLANEOUS SMALL ARMS

T1AA-	Cart., Ball, Cal. .50	100000 rds
-------	-----------------------	------------

BREAKDOWN OF ORDNANCE (Cont'd)

CHEMICAL CORPS AMMUNITION:

C1 Cylinder, Ignition for PPT ea	100 rds
C7 Grenade, Smoke, WP 15 ea	2471 rds
C8 Grenade, incendiary, AM-M14 ea	1428 rds
C4 Grenade, Smoke M18 (Green) ea	250 rds
C5 Grenade, Smoke, M18 (Red) ea	250 rds
C6 Grenade, smoke, M18 (Violet) ea	250 rds
C7 Grenade, smoke, M18 (Yellow) ea	275 rds
C8 Grenade, smoke, HC, AM-M18 ea	210 rds

HEADQUARTERS
2D INFANTRY DIVISION
DIVISION ORDNANCE OFFICE
APO 248

ROSTER OF OFFICERS AND DUTY ASSIGNMENTS

1. DIVISION ORDNANCE OFFICER. Lt. Col. Jack L. Grubb.
 - a. Commands Divisional Ordnance Unit.
 - b. Preparation and execution of Ordnance plans.
 - c. Advises Division Commander and Staff on all matters as pertains ordnance equipment and ordnance ammunition.
 - d. Provides information to the characteristics, capabilities and limitations of ordnance equipment and ordnance ammunition.
 - e. Supervises operation of field maintenance, procurement storage and distribution of ordnance materiel.
2. ASSISTANT DIVISION ORDNANCE OFFICER. Maj. Leo C. Cunningham
Assists Division Ordnance Officer in all phases of operation as may be required to enable him to accomplish his mission efficiently.
3. DIVISION MAINTENANCE OFFICER. Capt. Walter G. Jameson.
 - a. Advises Division Ordnance Officer on maintenance policies and problems of ordnance equipment.
 - b. Accumulates and evaluates information and prepares Statistical reports on status of ordnance equipment.
 - c. Conducts technical inspections of ordnance equipment in the hands of troops and supervises the rehabilitation of such equipment withdrawn from combat areas.
 - d. Prepares plans and policies for ordnance maintenance support.
4. DIVISION SUPPLY OFFICER. Capt. Frank E. Davidson.
 - a. Informs Division Ordnance Officer on supply policies, procedures and problems.
 - b. Supervision of the ordnance general supply situation including the procurement, storage and issue of such supplies.
 - c. Provides information on excessive rates of consumption and suspected infractions of supply economy.

ROSTER OF OFFICERS AND DUTY ASSIGNMENTS (Cont'd)

d. Maintains liaison with Supply officers of Corps and Army and Supply Officers of back-up ordnance depots responsible of the replenishment of stocks.

5. DIVISION AMMUNITION OFFICER. Capt. David M. Carson.

a. Notifies Division Ordnance Officer on policies, procedures and supply problems of ammunition.

b. Exercises Technical supervision and administration of ammunition supply.

c. Approves transportation orders from units and directs them to appropriate supply points.

d. Inspects the basic loads of units to insure availability and serviceability.

e. Maintains liaison with Corps and Army ammunition Officers responsible for the replenishment of stock.

HEADQUARTERS
2D INFANTRY DIVISION
DIVISION ORDNANCE OFFICE
APO 248

DAILY JOURNAL OF ACTIVITIES

- 1 Sep 1950 Company alerted for move to rear area 0930. Officer dispatched to Pusan 0830 to P.L.C. for purpose of getting weapons and supplies.
- 2 Sep 1950 Three additional vehicles dispatched to Pusan for supplies.
- 3 Sep 1950 Normal operation.
- 4 Sep 1950 Contact Team departed for Chon-do to 23d Inf. Critical shortage of the following ammunition:
 - 57mm Rifle Recoilles
 - 105 Howitzer
 - 60mm Mortar
 - 81mm Mortar
 - 4.2 Mortar
 - Flare, Trip
 - Rocket 3.5
 - Cartridge Cal. .45
- 5 Sep 1950 Established collecting point at Yongsoen (Collecting point No. 1). Ammunition shortage continues. Capt. Kenneth F. Searcy placed in command of 703d Ord. Co. 1st Lt. Carl E. Williams appointed Assistant Maintenance Officer. 1st Lt. William J. Anderson appointed 2d Platoon Leader.
- 6 Sep 1950 Ammunition shortage continues.
- 7 Sep 1950 Conference with Lt. Col. Grubb of 2d Division Ordnance, Major Schreiber and Capt. Federlin of 8046 Ordnance Group and Capt. Emmons of 68th Ord. Bn., for advisability of support of Divisional units. Established collecting point approximately 12 miles Northwest of Changyong (Collecting point No. 2)
- 8 Sep 1950 33th MM Co., located 1.4 miles East of Songso-Dong to provide limited support to Divisional units north of Changyong. Ammunition critical.
- 9 Sep 1950 Roads in poor condition due to rains. No track vehicles permitted on roads. Stop all recovery work.
- 10 Sep 1950 105 & 155 Ammo., zero balance at ASP. Condition of roads very bad. No evacuation possible.

DAILY JOURNAL OF ACTIVITIES (Continued)

- 11 Sep 1950 Received 105 & 155 Ammunition, alleviating temporarily the critical shortage. Restriction of 25 rds per gun per day - Carbine in critical short supply. 1st Platoon M32 caught fire, completely destroyed.
- 12 - 15 Sep
1950 Normal Operation.
- 16 Sep 1950 2nd Platoon and Section of Supply Platoon moved forward to new location, approximately 1 1/2 miles Northwest of Changnyong
- 17 Sep 1950 Balance of company moved to New location.
- 18 Sep 1950 Normal operation.
- 19 Sep 1950 Dispatched men to Miryang to pick up 10 DUKS for delivery to 9th Inf., attempted crossing of Naktong River.
- 20 Sep to
22 Sep 1950 Normal operation
- 23 Sep 1950 1st Platoon and Ammunition Section moved to new area across Naktong 1134.2 - 1400.9. Critical shortage of ammunition.
- 24 Sep 1950 2nd Platoon clearing out all work in Changnyong area.
- 25 Sep 1950 Normal operation.
- 26 Sep 1950 Entire company closed in approximately 6 miles east of Anui.
- 27 Sep 1950 Normal operation.
- 28 Sep 1950 Forward ASP established Anui.
- 29 Sep to
30 Sep 1950 Normal Operation.

HEADQUARTERS
2D INFANTRY DIVISION
DIVISION ORDNANCE OFFICE
APO 248

CSHIS-5
7 Nov 1950

COMMAND AND UNIT HISTORICAL REPORT
(CSHIS-5)

Period of report - 1 Oct 1950 - 31 Oct 1950.

1. Unit - Special Staff - Ordnance Section.
2. Mission - The mission of the Ordnance Special Staff Section, 2d Infantry Division is as follows:
 - a. Advise and make recommendations to the Commanding General and Staff on all matters as pertains Ordnance, both technical and tactical.
 - b. Preparation and execution of Ordnance plans.
 - c. Supervise Ordnance Field Maintenance Activities.
 - d. Provide information on the characteristics, capabilities and limitations of Ordnance equipment, and Ordnance ammunition.
 - e. Determine requirements, initiate procurement action, and supervise the distribution and storage of Ordnance general supplies and Ordnance ammunition.
 - f. Investigate and make recommendations, on instances of improper supply economy and any abuse of Ordnance equipment and Ordnance ammunition.
 - g. Investigate and make recommendations on mechanical and safety engineering matters as affects Ordnance equipment and Ordnance ammunition.
3. Organizational Statistical data.
 - a. Organizational changes within Special Staff Section during period:
 - (1) Capt Kenneth F. Searcy assigned as Division Maintenance Officer vice-Capt Walter G. Jameson relieved.
 - b. Roster of Officers, duties (See Incl 1)
 - c. Breakdown of operation (See Incl 2)
 - d. Daily Journal of activities (See Incl 3)

COMMAND AND UNIT HISTORICAL REPORT (Cont'd)

4. Principal problems encountered.

a. Due to long supply lines and priority of other supplies, ordnance parts and assemblies have been critical throughout the period. Items involved include engine assemblies, springs, tires and tubes, axle assemblies, brake lining, transmissions and transfer cases. Dead-line of General Purpose vehicles increased during the later part of this period due to the operating of the "Red Ball" class I & III convoy. Excessive speeds over rough roads, overloading and lack of 1st and 2d Echelon maintenance were the main causes for the large quantity of vehicles deadlined.

b. The unavailability of parts for track vehicles has resulted in the necessity for evacuating a large percentage of the Division's Track Vehicles for causes which could have been corrected in a very short time. Considering the importance of these vehicles in combat as well as the difficulty in obtaining replacements, it appears that a far greater effort should be exerted to make repair parts available.

4. Miscellaneous.

a. The desirability of sufficient organic ordnance to support the Division continues to prove itself. Placing an Army-controlled Medium Maintenance Company in continuous direct support relieves the situation a great deal, but it gives rise to the following situations:

(1) The MM Company is in support at a given location. The Division is ordered to move to an area 175 miles distant. In order to effect the move, the company must contact the battalion to which it is assigned which is located 175 miles distant. The battalion must then contact Group which is located at another point. By the time the movement of the company is affected, the Division has completed its move and possibly begun a second move, and the process is started all over again.

(2) The arrangement whereby the company serves one Commanding Officer and is rated by another produces no particular incentive to give "personalized" service or to exert maximum effort.

JACK H. GRUBB
Lt Col, Ord Corps
Div Ord Officer

3 Incls:

1. Roster of Officers and Duty assignments
2. Breakdown of operation
3. Daily journal of activities.

HEADQUARTERS
2D INFANTRY DIVISION
DIVISION ORDNANCE OFFICE
APO 248

ROSTER OF OFFICERS AND DUTY ASSIGNMENTS

1. DIVISION ORDNANCE OFFICER. Lt Col. Jack L. Grubb.
 - a. Commands Divisional Ordnance Unit.
 - b. Preparation and execution of Ordnance plans.
 - c. Advises Division Commander and Staff on all matters as pertains Ordnance equipment and Ordnance ammunition.
 - d. Provides information to the characteristics, capabilities and limitations of Ordnance equipment and Ordnance ammunition.
 - e. Supervises operation of field maintenance, procurement storage and distribution of ordnance materiel.
2. ASSISTANT DIVISION ORDNANCE OFFICER. Maj. Lee C. Cunningham

Assists Division Ordnance Officer in all phases of operation as may be required to enable him to accomplish his mission efficiently.
3. DIVISION MAINTENANCE OFFICER. Capt. Kenneth F. Searcy.
 - a. Advises Division Ordnance Officer on maintenance policies and problems of Ordnance equipment.
 - b. Accumulates and evaluates information and prepares Statistical reports on status of Ordnance equipment.
 - c. Conducts technical inspections of ordnance equipment in the hands of troops and supervises the rehabilitation of such equipment withdrawn from combat areas.
 - d. Prepares plans and policies for Ordnance Maintenance support
4. DIVISION SUPPLY OFFICER. Capt Frank E. Davidson.
 - a. Informs Division Ordnance Officer on supply policies, procedures and problems.
 - b. Supervision of the Ordnance general supply situation including the procurement, storage and issue of such supplies.

Encl 1

ROSTER OF OFFICERS AND DUTY ASSIGNMENTS (Cont'd)

c. Provides information on excessive rates of consumption and suspected infractions of supply economy.

d. Maintains liaison with Supply Officers of Corps and Army and Supply Officers of back-up Ordnance depots responsible of the replenishment of stocks.

5. DIVISION AMMUNITION OFFICER. Capt. David M. Carson.

a. Notifies Division Ordnance Officer on policies, procedures and supply problems of ammunition.

b. Exercises technical supervision and administration of ammunition supply.

c. Approves transportation orders from units and directs them to appropriate supply points.

d. Inspects the basic loads of units to insure availability and serviceability.

e. Maintains liaison with Corps and Army Ammunition Officers responsible for the replenishment of stock.

HEADQUARTERS
2D INFANTRY DIVISION
DIVISION ORDNANCE OFFICE
APO 248

BREAKDOWN OF OPERATION

The following is a breakdown of operation during period 1 Oct 1950 - 31 Oct 1950.

1. SUPPLY:

a. Major Items.

(1) Sixty-three (63) general purpose vehicles were issued. All issues were replacement issues through EUSAK allocations.

(2) One hundred eighty-two (182) instruments (SHL "J" Group) were issued of which thirty-seven (37) were received through battlefield recovery and reclamation.

(3) Two thousand eight hundred and eighty-five (2885) weapons were issued of which one thousand eight hundred and forty-three (1843) were received through battlefield recovery and reclamation.

b. Secondary Supply.

(1) During the period covered a total of two thousand nine hundred and thirty-five (2935) line items were requested by Divisional Units.

(2) A total of one thousand five hundred and forty-six (1546) line items were issued during period.

(3) An average of fifty-two percent issues was maintained during period.

2. MAINTENANCE:

a. Work Order processed:

G.P. Vehicles	529
Combat Vehicles	69
Small Arms	1897
Instruments	336
Artillery	29

Note: The above Job Order figures do not reflect a true picture inasmuch as the bulk of the small arms and artillery jobs and a large percentage of automotive jobs are done by Ordnance Contact teams within the using units area and are not accomplished on Job Order.

Incl 2

BREAKDOWN OF OPERATION (Cont'd)

3. AMMUNITION:

Due to the quiet sector in which the Division was located there were very few requests on issues during this period. Units were directed to maintain basic leads.

**HEADQUARTERS
2D INFANTRY DIVISION
DIVISION ORDNANCE OFFICE
APO 248**

DAILY JOURNAL OF ACTIVITIES

- 1 Oct 1950 Normal Operation.
- 2 Oct 1950 2d Maintenance Platoon closed Chonju 1400 - 1st Maintenance Platoon, Supply Platoon and Company Headquarters, remained to clear area at Anui.
- 3 Oct 1950 Section of Supply closed Chonju - Personnel withdrawn from Yuchon ASP - ASP continue to operate at Changyong, Haktong and Anui.
- 4 Oct 1950 Normal Operations.
- 5 Oct 1950 1st Maintenance Platoon and balance of Supply and Headquarters Platoon moved to Chonju.
- 6 Oct 1950 1st Maintenance Platoon moved to Vicinity Kongju to support 38th RCT.
- 7 Oct 1950 Normal Operations.
- 8 Oct 1950 Normal Operations.
- 9 Oct 1950 Lt Col Grubb together with personnel of Division Ordnance departed to select area for Division Ordnance, Vicinity Suwon.
- 10 Oct 1950 2d Maintenance Platoon and Balance of Company departed Chongju destination to site Vicinity Suwon. 1st Maintenance Platoon departed area Vicinity Kongju to new area. Entire Company closed in area approximately 7 miles south of YongDong'Po.
- 11 Oct 1950 Lt. Murray and 3 Enlisted Men departed for area occupied by 38th FA Trucks to inspect and clear area of duds after ammunition fire of last night. Capt Searcy contacted all units using M4A3 and M26 Tanks for purpose of determining exact number of serviceable tanks on hand returned to GP 1600 hours. One Officer, 37 EM departed for Pusan after replacement vehicles.
- 12 Oct 1950 Division Ordnance Officer and Assistant visited 60th Ordnance Group Vicinity Ascom City. 503d FA Bn., was contacted and Unit advised to deliver 155mm Howitzers to 702d Ordnance Maintenance Company for Semi-annual 6-month Gun inspection. Paint Shop set up in Maintenance Platoons to assist units in painting of vehicles. Division Supply Officer and Division Maintenance Officer contacting Divisional Units to determine Status of Major Items. Division Ammunition Section starting inspection of Divisional Units Ammo Basic Loads for safety, serviceability and quantities. General Bradley, Assistant Division Commander, visited 702d Ordnance Co.

DAILY JOURNAL OF ACTIVITIES (Cont'd)

- 13 Oct 1950 Normal Operations.
- 14 Oct 1950 General Bradley, Assistant Division Commander, visited 702d Ordnance Company area in reference to status of Tanks in for repair.
- 15 Oct 1950 Inspection of Basic Load of 38th Inf Regt., Divarty and 23d Inf Regt., completed. Plans made to start Technical Spot Check of Ordnance equipment of 38th Inf Regt., 16 Oct 1950. Priority on Maintenance and Supply directed by G-4 for 503d FA Bn and 9th RCT.
- 16 Oct 1950 Spot Check inspection of Ordnance Vehicles completed in 38th Inf Regt. Inspection of Ammunition Basic Loads completed in 72d Tank Bn and 2d Eng C Bn.
- 17 Oct 1950 Col Grubb received call from Div Arty S-4 in reference to replacement of M-5 Tractors (4 ea). Col Grubb called Artillery Section, EUSAK, Col Sullivan advised that no M5 Tractors available in Seoul-Inchon area. 65 on hand in Pusan. Assistant Division Ordnance Officer, called Ordnance Section EUSAK in reference to allocation of 4 each tractors M5 short in 503d FA Bn. Lt. Ottman, Scotch 208, Ordnance Supply stated that Tractors would be allocated and he would advise Division Ordnance Officer as to time to dispatch personnel to Pusan to accept delivery and ride as train Guards for return trip. Spot Check Inspection of Motor Vehicles of 503d FA Bn, 15 FA Bn., and 82d AAA Bn., completed.
- 18 Oct 1950 Capt Carson, DAO contacted Major Till, Ordnance Section EUSAK in reference to an Ordnance Disposal Squad. He was advised that Capt McGuire and Squad would be here this PM. BD Squad did not report to Division Ordnance this date.
- 19 Oct 1950 At 0930 Capt Carson Call Scotch 308. Major Bobsign advised that the responsibility for deduding the area now occupied by 38th FA Bn., had been turned over to the III Logistical Command and directed the DAO to call Col. Mejica, Philmore 708. DOO submitted written opinion on results of Board of Officers report on ammunition explosion that occurred in 38th FA Bn., 10-11 October. Co "I" 38th Infantry Regt., reports large quantity of ammunition near Seoul north of Han River. Lt Murray assistant DAO dispatched to investigate. Lt Murray reported 106 rounds of 105mm Howitzer in area. In all probability the residue from an air drop. Major Till and Lt Berent, 8th Army Ordnance, Ammunition Section visit DOO in reference to ammunition problems. Convoy consisting of 63 Wheeled vehicles and 32 Water trailers arrived from Pusan. Items will be issues as replacement against Division shortages

DAILY JOURNAL OF ACTIVITIES (Cont'd)

- 20 Oct 1950 One truck and detail of 4 men dispatched to Vicinity of floating bridge site entering Seoul area to collect and evacuate ammunition reported by 38th Inf Regt. D.O.O. to Division Headquarters for conference in reference to Board of Officers report on Ammunition Explosion that occurred in 38th FA Bn., area. Lt Col Prather and Lt Col Hill, EUSAK, Ordnance Section, visited DCO for purpose of conference on past and future Ordnance Support. Spot Check Technical inspection of Division Artillery and attached Artillery Battalions completed.
- 21 Oct 1950 Normal operations. Spot Check Inspection of 2d Engrs Bn., and 2d Med Bn., completed.
- 22 Oct 1950 Ordnance Section EUSAK called DCO, giving release number 8A-0W279 on 4 each Tractors M-5 short in 503d FA Bn. Supply notified by FMV to pick up 15 Trucks 1/4 Ton and 10 trailers 1 Ton at Pusan. Names of individuals to be dispatched to Pusan furnished Ivanhoe AG. Meeting of Ivanhoe G-4 in reference to furnishing 2 1/2 Ton trucks to transport Class I & III supplies, Ordnance to furnish necessary maintenance crews and wreckers only. Spot check inspection of 2d MP Co., 2d Sig Co., and Hq Co., 2nd Infantry Division, completed. Wrecker dispatched to site of Floating Bridge Vicinity Kongju to retrieve 3/4 Ton Weapons Carrier belonging to Ivanhoe rear returned to area. Weapons Carrier was not located.
- 23 Oct 1950 Spot Check inspection of 2d QM Co., and 702d Ord Co., completed. This completes the Spot Check Inspection program for all units of the 2d Infantry Division.
- 24 Oct 1950 DCO and Assistant DCO visited Ordnance Section EUSAK for conference with Colonel Winningstad and Lt. Col. Prather.
- 25 Oct 1950 Contact teams that accompanied convoys of Class I and III supplies to Pyongyang returned to area. 15 men transported to Kimpo airfield to be flown to Pusan to pick up vehicles. 19th Ord MM Co., alerted for move to new area. 15 men returned from KIMPO Airfield. Transportation not available.
- 26 Oct 1950 Contact team, 2d Platoon departed to service convoy of 38th Inf Regt., going to Pyongyang. Detail of men departed for KIMPO air base to be transported to Pusan to drive vehicles back to 702d Ord Co. 73d Tk Bn., called for ammunition inspection to check the safety of ammunition found in Battalion area. Advanced detachment 19th MM Co., departed to select new area., vicinity Sariwon. Detail of 15 men returned from KIMPO air base, transportation not available

DAILY JOURNAL OF ACTIVITIES (Cont'd)

- 27 Oct 1950 19th Ord MM Co., departed 0530 hours for new area. Detail of 15 men, 1 Truck 2½ Ton and trailer departed for Pusan after vehicles.
- 28 Oct 1950 1st Platoon, Supply Platoon, DCO and DAO alerted for move to Pyongyang 29 Oct 1950.
- 29 Oct 1950 1st Platoon, Supply Platoon, DCO and DAO moved into School yard on outskirts of Hwangju.
- 30 Oct 1950 Division Ordnance less 2d Platoon moved to School Yard in Pyongyang. Lt Col Grubb and Major Cunningham visited G-4 2d Infantry Division. Problem of maintenance of vehicles on "Red Ball" convoy was discussed. Col Grubb recommended that the "Red Ball" sign be removed from all 2d Infantry Division vehicles and that Convoy discipline be maintained. Normal convoy speed to be strictly adhered to the extreme rough roads and lack of 1st and 2d Echelon maintenance on vehicles.
- 31 Oct 1950 Division Ordnance Officer submitted a letter to Chief of Staff, 2d Infantry Division in reference to mis-use of vehicles attached to I Corps being used in hauling Class I and III supplies. Vehicles are receiving no maintenance and excessive speeds are causing premature mechanical failures.

QM Sect

OFFICE OF THE DIVISION QUARTERMASTER
Second Infantry Division
APO 248

7 October 1950

SUBJECT: Historical Report from 1 September 1950 to 30 September 1950,
Quartermaster Section, 2nd Infantry Division

TO: G-4
2nd Infantry Division
Attn: Historian

Attached is an account of activities for Quartermaster Section
from 1 September 1950 to 30 September 1950, submitted in accordance with
Staff Memorandum Number 9, Headquarters, 2nd Infantry Division, dated 29
August 1950.

ARNOLD C. GILLIAM
Lt Col QMC
Div Quartermaster

HISTORICAL REPORT, QUARTERMASTER SECTION
1 Sept 50 to 30 Sept 50

1 Sept 50: Four 2½ ton cargo trucks hauled ammunition for 23rd Infantry to forward area. Seven 2½ ton cargo trucks hauled 105 howitzer ammunition to forward area upon call from G-4. Lt Turner with five 2½ ton trucks reported to Division Provost Marshall to haul Korean refugees that were crippled and aged out of forward area. Ten 2½ ton trucks moved to Division CP to haul supplies as requested by G-4. Lt. Sowl with ten 2½ ton cargo trucks hauled two companies to Division CP; companies made up from Division Rear and Division Band. Lt. Hunt with eighteen 2½ ton cargo trucks reported to Miryang Railhead to haul ROK troops to Division CP to be assigned to Division Units. Three 2½ ton cargo trucks reported to ASP Dump at Yohg Chungo to move tank ammunition forward as requested by G-4. All truck drivers were instructed to return to Division Headquarters after finishing assigned jobs to form a Provisional Truck Company to be used as required by Division Headquarters. Company laundry processing undercloths and socks to be returned to stock. Five hundred ROK troops unloaded and processed with water and one days rations and hauled to forward area. Class I issued 17,765 B, 4,076 C, 3,118 PX Rations, 100 packages of cigarettes, and 19,346 cans of beer. Class III issued 97 drums of gasoline and miscellaneous oil. Fifty Korean females were hired to work in laundry. Seventeen cans water and seventeen cases of C Rations were prepared and delivered to air strip to be free dropped to elements of the Division.

2 Sept 50: One field range cabinet, M-37, and miscellaneous tools repaired and returned to stock. Repair work done by Class II and IV Sections. Thirty-nine trucks dispatched to haul Marines to forward area. Class I issued 13,743 B and 13,034 C Rations. Class III issued 257 drums gasoline. Bath unit returned from 9th RCT and being held in reserve. Increase of 5,000 rations due to supply of 1st Marine Brigade. The abnormal issue of C Rations due to inability of kitchens to be utilized by units.

3 Sept 50: 1st Lt. Hawkins reported in and assigned to Field Service Platoon as Platoon Leader with duties as GRS Officer. Eight cans of water prepared and delivered to air strip for air drop. Received and unloaded two cars of Class II and IV supplies. DQMSO went to Pusan to check on status of supplies. Following list of units with approximate strength were added to Division Quartermaster Supply list:

Task Force 76	225
1st Div Marine Brigade	3,670
6 22nd MP Co	202
19th RCT	3,387
Hq 24th Div	320
6th MTB	613
24th DivArty Air Sec	65
11th FA Bn	780
13th FA Bn	810
Hq 24th DivArty	200
Co A 78th Bn	101

HISTORICAL REPORT contd

Class I issued 12,300 A, 6,376 B, and 16,000 C Rations. Class II and IV issued 1/2 days shoes, clothing, and equipment. Class III issued 24,000 gallons gasoline. Shower units located at 9th RCT, 23rd RCT, and 38th RCT. Total of 39 interments, one unidentified.

4 Sept 50: One shower unit returned from 23rd RCT. Class I issued 15,900 B and 10,318 C Rations. Interment report negative.

5. Sept 50: DQMSO departed for Pusan to get emergency requisition filled for blankets to be used by 2nd Medical Battalion. Class I issued 15,833 A, 4,980 B, and 7,897 C Rations. Class III issued 12,487 gallons gasoline. Forty-eight identified interments.

6 Sept 50: Class I issued 1,983 A, 14,567 B, and 10,697 C Rations. Class III issued 15,015 gallons gasoline. Laundry washed 1,150 sets of fatigues and 900 pieces for the hospital. Two shower units in Company for repair. Total of 37 interments, 31 identified, and 6 unidentified. Five hundred ROK soldiers unloaded and processed with water and rations.

7 Sept 50: Class I issued 16,008 B and 5,849 C Rations. Class III issued 15,650 gallons gasoline. Laundry washed 2,000 pieces. Five hundred pounds salvage collected. Total of 63 interments, 9 unidentified, and 54 identified. DQMSO returned from Pusan Base QM. Lt Hawkins departed for Pusan to deliver 95 personal effects and pick up GRS Forms.

8 Sept 50: Class I issued 15,752 A, 350 B, and 4,004 C Rations. Class III issued 22,500 gallons gasoline. Laundry washed 2,500 pieces. Five truckloads bags sent to Pusan Base QM. One truckload salvage from 9th Inf. Regt. Sixty interments, 48 identified, and 12 unidentified. Six entrenching shovels, seven mountain stoves, three M-37 field range fire units, one M-37 field range cabinet, and one Coleman lantern repaired and returned to stock. Lt. Hawkins returned from Pusan with supply of GRS Forms and bag seals.

9 Sept 50: Class I issued 15,564 A, 1,924 B, and 3,600 C Rations. Laundry washed 1,000 pieces for hospital, 230 blankets, and 1,700 sets fatigues. One ton salvage received from 38th Inf. Regt. Thirteen truckloads salvage QM supplies shipped to Pusan Base Command. Thirty-five interments, 3 unidentified, and 32 identified. Received and unloaded five cars Class II and IV supplies.

10 Sept 50: Received and unloaded five cars Class II and IV supplies. QMSO departed for Pusan with weekly requisition for QM supplies. Total of 37 interments, 6 unidentified and 31 identified. Class I issued 1,136 A, 18,770 B, and 1,706 C and 5 in 1 Rations. Class III issued 16,900 gallons gasoline. Laundry washed 1290 pieces for hospital, 7 socks of socks, and 1,350 sets of fatigues.

11 Sept 50: DQMSO returned from Pusan Base QM. Class I issued 22,394 B and 1,679 5 in 1 Rations. Class III issued 21,050 gallons gasoline. Total of 26 interments, 23 identified, and 3 unidentified. Thirty-seven bags of underwear and socks washed and 1,760 pair fatigues washed. Four trucks of salvage from 23rd Infantry and hospital.

12 Sept 50: One shower unit reported to 23rd RCT area. Set up detail

HISTORICAL REPORT contd

of one officer and three EM to inventory personal effects of officers and EM KIA. Detail of one NCO and ten Korean laborers to process excess shoes to be returned to units. Twenty-eight interments, one unidentified. Class I issued 17,238 B and 1,639 5 in 1 Rations. Class III issued 15,650 gallons gasoline. 1,500 pieces laundered.

13 Sept 50: Class I issued 16,538 B and 5,749 5 in 1 Rations. Class III issued 17,000 gallons gasoline. One tone of salvage from hospital. Fourteen bags socks and shorts, 500 pieces from hospital, and 1,620 pieces washed. Sixteen interments, three unidentified. Division Quartermaster went to Division Forward for meeting with Division Chief of Staff.

14 Sept 50: One car QM salvage loaded and shipped to Pusan Base QM. 565th GRS Platoon of one officer and twenty-two EM attached to Company. P & C Officer departed for Pusan at 0800 hours and returned at 1800 hours. Six gasoline operated lanterns, two 1 burner stoves, 7 M-37 fire units, and 6 immersion heaters repaired by Class II section and returned to stock. Total of 19 interments, one unidentified. Class I issued 19,213 B and 2,314 5 in 1 Rations. Class III issued 20,400 gallons gasoline.

15 Sept 50: Received and unloaded 3 cars Class II and IV supplies. Loaded and shipped to Pusan Base QM two cars Class II and IV salvage. Total of seven interments, all identified. Class I issued 19,997 B and 1,115 5 in 1 Rations. Class III issued 21,900 gallons gasoline. Laundered 700 pieces for hospital, 2 bags caps, 1,440 HBT's and 350 blankets.

16 Sept 50: One car QM salvage loaded and shipped to Pusan Base QM. Total of 17 interments, 1 unidentified. Class I issued 22,034 B and 1,705 5 in 1 Rations. Class III issued 18,750 gallons gasoline. Laundered 27 bags underwear, 17 bags socks, and 18 bags HBT's. Two trucks salvage from 2nd Medical Battalion.

17 Sept 50: Class I issued 20,657 B and 5,000 C Rations. Class III issued 13,950 gallons gasoline. Laundered 2,100 HBT's and 500 blankets. Total of 15 interments, all identified.

18 Sept 50: GRS Section departed from Miryang at 1300 hours. Opened collection point at Changnyong at 1530 hours. Class I issued 21,237 B and 5,000 C Rations. Class III issued 7,800 gallons gasoline. Total of 45 interments, 3 unidentified.

19 Sept 50: Class I issued 21,104 B, 1,624 C, and 950 5 in 1 Rations. Class III issued 7,800 gallons gasoline. DQM, Class I, Class III, and three truck platoon of 100 EM and 6 Officers arrived at Changnyong 0800 hours and opened for operation. Dispatched message to Ivanhoe 4 giving location of supply dumps. Total of 18 interred, 1 unidentified. 120 EM and 6 Officers remained in Miryang to operate Railroad. Milage from Changnyong to Miryang and return 70.

20 Sept 50: Class I issued 21,104 B, 1,624 C, and 950 5 in 1 Rations. Class III issued 16,650 gallons gasoline. 21 trucks returned to Miryang to haul Class I supplies. Division QM and P & C Officer went forward across the Naktong River.

21 Sept 50: Thirty-two trucks departed for Miryang and returned with

HISTORICAL REPORT contd

Class I and III supplies. Total interred 5, all identified. Class I issued 3,392 A, 15,311 B, 1,296 C, and 2,580 5 in 1 Rations. Class III issued 23,995 gallons gasoline.

22 Sept 50: Total of 57 interments, unidentified 9. DQMO departed for Miryang and returned with 30 trucks loaded with Class I and III. Class I issued 15,400 A, 5,131 B, 1,800 C, and 805 5 in 1 Rations. Class III issued 21,685 gallons gasoline.

23 Sept 50: Class I issued 20,951 B, 890 C, and 1,424 5 in 1 Rations. Class III issued 26,625 gallons gasoline. Laundry closed in Miryang and preparing to move to Changnyong. Total of 25 interments, 8 unidentified. Forty-five trucks departed for Miryang and returned with Class I, II, and III supplies.

24 Sept 50: Division QM departed for Miryang to check QM supplies. Thirty-two truckloads Class I and II supplies delivered to Changnyong Truckhead. Class I issued 10,000 A, 10,737 B, 5,176 C, and 860 5 in 1 Rations. Class III issued 21,545 gallons gasoline. Total of 46 interments, 11 unidentified, and 35 identified.

25 Sept 50: DQMSO returned from Base QM at Pusan. Twenty-seven 2½ ton cargo trucks dispatched from Miryang Railhead with Class I and III. Total of 29 interments, 4 unidentified. Class I issued 8,774 A, 9,937 B, 2,705 C, and 2,395 5 in 1 Rations. Class III issued 19,930 gallons gasoline. Dispatched 25 2½ ton trucks to 9th Infantry to haul personnel. Six 2½ ton cargo trucks were ambushed by enemy. One truck got out of ambush and five abandoned.

26 Sept 50: Moved Class III section to Hyopchon to set up Class III dump. Thirty-two truckloads POL moved. Fourteen 2½ ton cargo trucks departed for Miryang and returned with Class I supplies. Division QM Officer and P & C Officer made a recon to Hyopchon to pick an area to move the truckhead from Changnyong. Class I issued 7,226 A, 12,008 B, 5,228 C, and 4,105 5 in 1 Rations. Class III issued 7,700 gallons gasoline. Five 2½ ton cargo trucks recovered from ambush. One motor shot up and needed replacing. All trucks were repaired and put back in operation.

27 Sept 50: Colonel Gilliam departed from Changnyong with first serial of convoy, moving ODCM and truckhead to Hyopchon. Departed at 0730, closed in at Hyopchon at 1130 hours. Unloaded trucks and 30 trucks departed for Miryang for Class I and III supplies. Class I issued 5,276 B, 2,616 C, and 1,293 5 in 1 Rations. Class III issued 21,450 gallons gasoline. Total of 9 interments, all identified. Milage from Hyopchon to Miryang and return 140 miles.

28 Sept 50: Total of 9 interments, all identified. Twenty-five trucks dispatched for Miryang to haul Class I and III supplies. Division Quartermaster and P & C Officer made a recon to Anui to find place to move truckhead. Class I issued 12,725 B, 2,583 C, and 1,467 5 in 1 Rations. Class III issued 26,110 gallons gasoline.

29 Sept 50: Fifteen trucks departed from Hyopchon to Miryang to haul Class I and III supplies. DQMSO and ODCM departed for Anui. First serial departed from Hyopchon to Anui at 0700 hours. Second serial arrived from Miryang at Anui at 0900 hours. Third serial departed from Hyopchon to Anui. All trucks closed in at Anui at 1800 hours. Milage from Anui to Miryang and

HISTORICAL REPORT contd

return 210 miles.

30 Sept 50: DQMSO returned to Miryang Railhead to check on status of winter clothing supply. Twenty-five trucks departed from Anui for Miryang to haul Class I and III. Total of 14 interments, 2 unidentified.

A total of 36 tons of excess clothing and salvage was shipped from 1 Sept 50 to 30 Sept 50. Processed enlisted and officer KIA, MIA, and evacuated personnel for a total of 115. Company was divided operating Railhead and Truckhead.

OFFICE OF THE DIVISION QUARTERMASTER
Second Infantry Division
APO 248

6 November 1950

SUBJECT: Historical Report from 1 October 1950 to 31 October 1950,
Quartermaster Section, 2nd Infantry Division

TO: G-4
2nd Infantry Division
Attn: Historian

Attached is an account of activities for Quartermaster Section from 1 October 1950 to 31 October 1950, submitted in accordance with Staff Memorandum Number 9, Headquarters, 2nd Infantry Division, dated 29 August 1950.

I. L. Luthi
I. L. LUTHI
Major QMC
DQC Exec Officer

HISTORICAL REPORT, QUARTERMASTER SECTION

1 October 1950 to 31 October 1950

1 Oct 50: P & C Officer and DQM Office departed from Anui for Chonju on reconnaissance for an area to put DQM Truckhead. Arrived at Chonju at 1300 hours, located area and received 13 truckloads of gasoline. Total of 6 interments, one unidentified.

2 Oct 50: Division Quartermaster and remainder of trucks from Anui arrived at Chonju. All trucks closed in at 1715 hours except one 2½ ton truck. Truck dispatched to pick up load from lost truck.

3 Oct 50: One lost 2½ ton truck recovered and brought into 2d QM Company Motor Pool. Thirty-five trucks departed for Chinju and returned with POL. One shower unit set up for operation in Division CP Area. GRS set up collection point in Chonju area. Class I issued 18,911 B and 45 C Rations. Class III issued 16,405 gallons gasoline.

4 Oct 50: Class I issued 14,022 B, 77 C, and 86 5 in 1 Rations. Class III issued 17,980 gallons gasoline. Laundry washed 1,000 pieces for hospital. Shower unit serviced approximately 1,000 men. Dispatched 25 trucks to Chinju to pick up Class I and III supplies at 1420 hours. Received message from 9th RCT requesting availability of rations at Chinju. Dispatched message to S-4, 9th RCT answering his message that train was enroute to Chinju from Miryang. Division Quartermaster departed from Chonju at 1800 to check on the arrival of supply train. DQM and driver were fired on by guerrillas dressed as civilians on road 9 miles south of Chonju and fired on again by 9th Infantry road block near Hamyong.

5 Oct 50: DQM returned from Chinju and Mason. 25 trucks dispatched to Mason to pick up Class I and III supplies when no supplies arrived at Chinju. Received convoy of 25 trucks from Mason loaded with Class I and III. Distance between Chonju and Mason approximately 220 miles. Class I issued 14,022 B, 77 C, and 86 5 in 1 Rations. Class III issued 17,980 gallons gasoline.

6 Oct 50: DQM departed for Nonsan on a reconnaissance to locate area to move Division Quartermaster and truckhead. DQM Executive Officer reported in from Railhead at Chinju to check with DQM on status of supplies and the movement of the railhead from Chinju to Nonsan. 20 trucks from 60th TC returned from Chinju with Class III supplies. 75 trucks from 2d QM Company returned from Chinju with Class I and III supplies. 26 trucks departed from Chonju for Chinju to pick up Class I supplies. Class I issued 30,481 B Rations. Class III issued 31,250 gallons gasoline. Class II issued 3,557 sweaters.

7 Oct 50: DQM Executive Officer returned from Chonju to Chinju Railhead. 26 trucks returned from Chinju with Class I and III supplies. Loadingsupplies in preparation of movement from Chonju to Nonsan.

HISTORICAL REPORT contd

8 Oct 50: ODQM and GRS Section departed from Chonju for Nonsan at 0740. Arrived at 0950. QAO and Truckhead departed from Chonju at 0900 and arrived in Nonsan at 1120. All trucks closed in at 2330 hours. Set up QM Class III dump at rail station.

9 Oct 50: Dispatched 20 trucks to Chonju to haul empty gas drums to Nonsan. Dispatched 20 trucks to Kunsan to haul Class I and III supplies from LST. Two Officers and 49 EM from Chinju joined ODQM and Railhead at Nonsan at 1130 hours.

10 Oct 50: Division Class I and III supply train from Kunsan arrived. Advance party departed for Suwan to pick area to set up Division QM. 21 trucks departed and returned from Kunsan with Class III.

11 Oct 50: First convoy departed from Nonsan at 0630 and arrived at Suwan at 1230. All trucks and 2d QM Company closed in at Suwan at 1315 hours. Supply train from Mason arrived at 1500 hours with Class I, II, III, and IV supplies.

12 Oct 50: Class I and III train arrived at 0300 from Seoul. Class I, II, III, and IV issuing supplies. Received message from Class I Officer at Mason to ask Army to have train moved from Mason to Suwan. Class I issued 14,299 A, 138 C, and 35 5 in 1 Rations. Class II issued 2 days clothing and equipment. Class III issued 30,900 gallons gasoline.

13 Oct 50: Carried on maintenance of equipment. DQM and DQMSO went to Ascom City to check with CO, 6th QM Group, on status of supplies. DQM radio went out of order and was put in shop for repair. Class I issued 13,735 A and 50 5 in 1 Rations. Class II issued 1 days clothing and equipment. Class III issued 23,450 gallons gasoline.

14 Oct 50: Dispatched 30 trucks to haul 9th Infantry personnel from TRO, Suwan, to bivouac area. Following list of units with approximate strength were added to Division QM supply list: 60th Trk Co, 122; 19th Ord, 230; 212th MP, 61; and 8076 Evac Hosp, 160. Class I issued 3,017 A, 11,939 B, 60 C, and 35 5 in 1 Rations. Class II issued 1/2 days clothing and equipment. Class III issued 18,050 gallons gasoline.

15 Oct 50: No trains for Class I and III for past 3 days. Supply on hand none. DQMSO made trip to Yongdungpo and located 5 cars POL and 2 cars Class I that were lost in the railroad yards. Continued maintenance on trucks and personal equipment. Class I issued 4,849 A, 14,452 B, 4 C, and 100 5 in 1 Rations. Class II issued 1/2 days clothing and equipment.

16 Oct 50: DQM and P & C Officer made reconnaissance looking for an area to set up new railhead. Returned at 1200 hours. First convoy departed for new area in vicinity of Yongdungpo. Class I issued 18,290 B, 54 C, and 30 5 in 1 Rations. Class III issued 15,400 gallons gasoline.

17 Oct 50: One Officer and 12 EM joined the Company from Mason. Train arrived at 0300 hours. Second convoy departed from Suwan to vicinity of Yongdungpo. All Class I and III supplies were moved to new area.

18 Oct 50: Completed movement of Company and railhead from Suwan to

HISTORICAL REPORT contd

Yongdungpo. Issued available items of winter clothing to 38th and 23rd Infantry. DQM SO made trip to Headquarters, 8th Army CM. Class I issued 8,125 B, 114 C, and 110 5 in 1 Rations. Class III issued 11,600 gallons gasoline.

19 Oct 50: Continued issuing winter clothing to front line units. All supplies unloaded from train from Suwan. Class I issued 14,091 B, 449 C, and 80 5 in 1 Rations. Class III issued 11,600 gallons gasoline.

20 Oct 50: DQM and P & C Officer went to Headquarters, 8th Army. Class I issued 13,238 B, 30 C, and 30 5 in 1 Rations. Class III issued 19,150 gallons gasoline. Laundry servicing units of Division on rotation basis.

21 Oct 50: Loaded 10 2 $\frac{1}{2}$ ton trucks with POL and 5 2 $\frac{1}{2}$ ton trucks with B Rations to be moved out to set up truckhead. Class I issued 13,975 A and 463 C Rations. Class III issued 5,850 gallons gasoline.

22 Oct 50: Two Officers and 35 EM departed for Sariwon to set up POL dump to service 9th and 23rd RCT's. Class I issued 14,478 A, 3,401 B, and 16 C Rations. Class III issued 3,900 gallons gasoline.

23 Oct 50: Class II unloading supplies at railhead. Hauling Class I supplies from Ascom City. Winter clothing received and issued to Division units from 17 Oct 50 through 23 Oct 50: US Troops: drawers, wool, 14,379; undershirts, wool, 12,360; suspenders, trouser, 6,978; trousers, field cotton, 13,712; trousers, field wool, 9,631; cap, field cotton, 9,959; shirt, wool OD, 7,164; bag, sleeping mountain, 3,556; case f/bag, sleeping, 3,566. ROK Troops: suspenders, trouser, 3,283; trousers, field cotton, 6,566; cap, field cotton, 3,283; and jacket, field, M-43, 3,283. Class I issued 12,780 B and 78 C Rations. Class III issued 27,200 gallons gasoline. Class II and IV issued 1 days clothing and equipment.

24 Oct 50: Fourteen 2 $\frac{1}{2}$ ton trucks returned from Sariwon. One 2 $\frac{1}{2}$ ton cargo truck wrecked in vicinity of Kosang; damaged beyond repair. Truck was picked up by 7th Ord Company. Beer ration received for combat elements. Received 15,000 A Rations. Class I issued 12,780 B and 78 C Rations. Class II and IV issued 1 days clothing and equipment. Class III issued 27,200 gallons gasoline.

25 October 50: 2d Truck Platoon had 11 2 $\frac{1}{2}$ ton trucks depart for Sariwon; 7 loaded with rations and 4 loaded with Class II and IV supplies. 1st Truck Platoon had 14 trucks hauling Class I supplies from Ascom City. 3rd Truck Platoon doing maintenance work on trucks. Following list of winter clothing and equipment issued to Division units: US Troops: shirt, wool OD, 2,514; trousers, wool OD, 2,514; ROK Troops: drawers, wool, 2,313; undershirts, wool, 2,313; hood, jacket or overcoat, 768; bag, sleeping, mountain, 768; case f/sleeping bag, 768; shirt, wool OD, 863; trousers, wool OD, 863. Class III issued 25,750 gallons gasoline. Class II and IV issued 4 days clothing and equipment. Class I issued 14,011 A, 933 C Rations. 15 2 $\frac{1}{2}$ ton trucks hauling rations from Ascom City to ration point at Yongdungpo. 3 2 $\frac{1}{2}$ ton trucks departed for Sariwon with POL. 11 2 $\frac{1}{2}$ ton trucks returned from Sariwon. 3 Officers, 26 EM, and 13 ROK's moved to

HISTORICAL REPORT contd

Port of Haeju, arriving at 1500 hours. Proceeded to unload boats at 1600 hours, utilizing POW's for labor. The following amount was unloaded by 2330 hours: 450 tons, 333 drums or 16,650 gallons POL.

27 Oct 50: Fourteen 2½ ton trucks hauling Class I and III from Aecom City. Trucks departed Yongdungpo for Sariwon with 12,000 rations. Haeju -- Commenced unloading 0600 hours. Unloaded 250 tons Class I supplies. Loaded out first train for Sariwon consisting of 131 drums POL (6,550 gallons) and 15,000 5 in 1 Rations and 8,400 C Rations. Issued 94 drums POL to 23rd RCT. Loaded 176 drums of POL on 23rd RCT vehicles to go forward to I Corps at Pyongyang and 13,000 combat rations. Loaded 13 trucks of 72d Tank, also for delivery to I Corps; 252 drums POL or 12,600 gallons. Commenced unloading boats at 1600 hours and off-loaded 1,514 drums. Completed unloading of all boats at 2110 hours.

28 Oct 50: Loaded 21 trucks from 38th RCT for delivery at Pyongyang at 0630 hours. Load consisted of 363 drums of POL (18,150 gallons). ODJ Office departed from Yongdungpo for Haeju to join the DCM. 7 2½ ton trucks departed from Yongdungpo for Sariwon loaded with Class I supplies. Yongdungpo -- winter clothing issued: US Troops: trousers, wool OD, 1964; and shirts, wool OD, 1,964; ROK Troops: trousers, wool OD, 1,021; and shirts, wool OD, 1,021.

29 Oct 50: Fourteen 2½ ton truck convoy departed Haeju for Yongdungpo and returned with Class I. Korean LST 213 docked and 20% of cargo discharged by 2400 hours. Issued 12 ROK soldiers winter clothing. Dispatched G-1 radio message on status of Indigenous Labor Report. Yongdungpo -- winter clothing issued: US Troops: trousers, wool OD, 262; and shirts, wool OD, 215. ROK Troops: trousers, wool OD, 262; and shirts, wool OD, 262.

30 Oct 50: One train departed for Sariwon loaded with 3,000 cases 5 in 1 Rations and 13,145 gallons POL. Continued unloading LST 213. Completed unloading at 1930 hours; 3,000 drums miscellaneous POL, 30,000 B and 15,000 combat rations. Sent G-4 message reporting status of unloading LST.

31 Oct 50: Sent message to G-4 giving status of supplies on hand at Haeju as of 31 Oct: 125,000 gallons Mogas, 1,000 gallons Avgas, 4,000 gallons OE 30, 600 gallons GO 90, 5,000 gallons OE 10, 550 gallons OE 50, 30,000 balanced B Rations, and 15,000 Combat Rations. Dispatched message to DCMSO at Yongdungpo to check on status of supply for tent stoves. Laundry unit reported in from Yongdungpo at 2330 hours. 12 truck convoy arrived from Yongdungpo loaded with A Rations.

Sig Seet

HEADQUARTERS
2D INFANTRY DIVISION
APO 248
Office of the Division Signal Officer

12 October 1950

SUBJECT: Narrative History

TO : Commanding General
2d Infantry Division
APO 248
ATTN: G-2

1. MISSION:

- a. Provide signal communication for division headquarters to include communication to units operating directly under division headquarters.
- b. Provide photography, signal supply, and field maintenance of division signal equipment.

2. CAPABILITIES:

- a. Staff planning, supervision of communication training and other signal activities.
- b. Wire and radio communication to units directly under division headquarters.
- c. Teletypewriter service
- d. Limited Radio Relay Communication
- e. Messenger and Message Center service for division headquarters.
- f. Signal Supply service and field maintenance of Signal Corps Equipment.
- g. Still and motion picture photography to include processing still pictures.
- h. Providing limited numbers of motion picture and slide projectors.

3. DAILY JOURNAL ENTRIES SIGNAL SECTION

1 September 1950 - Maun-ni, Korea.

Signal Jump Team making advance Command Post installation 4 miles north of Yongsan on Yongsan Changnyong road. All lines out by enemy action between advance Command Post and Division Artillery and advance Command Post and 9th RCT. Signal Officer and advance Signal Team ordered to return to the Division Command Post. Closed out advance installation and returned to Division Command Post. Major Theodore A. Bruner assigned 2d Signal Company, Assistant Division Signal Officer.

2 September 1950

All wire circuits disrupted between Yongsan and Changnyong. Radio circuits only communication to Division Artillery 23rd RCT and 38th RCT.

3 September 1950

Established VHF radio relay circuit to Division Artillery from 9th RCT. Installed Ivahhoe switch at 9th RCT (Yongsan).

4 September 1950

SECRET

Obtained helicopter from 1st Marine Division to install a VHF radio relay station on hill 593 for direct relay from Ivahhoe to Ivory.

5 September 1950

Password compromised. Units notified and new countersign issued.

6 September 1950

VHF radio relay telephone circuits established to Ivory. Index (9th RCT) and Lightning (25th Infantry Division). All wire lines to Division units unreliable due to enemy action.

7 September 1950

General Aiken, Chief Signal Officer, U. S. Army visited Division discussed recommendations for changes in Signal equipment for Infantry Divisions with Division Signal Officer. Division Signal Officer recommended that Infantry Divisions be authorized:

- (1) 5 reach radio sets SCR-399
- (2) Division Signal Company be authorized 100 miles Spiral 4 Cable
- (3) VHF equipment be increased to 8 terminal stations and 2 relay stations with necessary allied equipment, vehicles and operating personnel.
- (4) Division Signal Company be authorized one HO-17 or similar mobile unit for cryptographic equipment.

8 September 1950

Ivory Command Post moved. Telephone communications disrupted pending relocation of VHF telephone equipment at new Command Post.

9 September 1950

Relocation VHF relay equipment to furnish 2 voice circuits to Divarty from Ivahhoe by using field wire from relay station, hill 593.

10 September 1950

Lt's Smith and Simons departed for Divarty to install wire lines to 23rd and 38th RCT's.

11 September 1950

Replacing Division switchboard TC-12 with a TC-4 to care for increased telephone trunks. Wire lines to Index disrupted near Yongsan due to artillery fire.

12 September 1950

Completed installation of TC-4 switchboard. Wire lines rerouted to 9th RCT due to destruction by fire from burning villages. Division Signal Officer visited Signal Office Eighth Army.

13 September 1950

Lt Simons departed for Division Rear (Miryang) to cut out Division trains switchboard. Peg count on Division switchboard taken from 0900 to 2100 hours showed 1143 calls made during the period, an average of 96 calls per hour.

14 September 1950

Major Brunner departed from Command Post with signal jump team to make installation at new Division Command Post 2 miles south Changnyong on Yongsan-Changnyong road with instructions to have installation complete by 1300 15 September 1950.

15 September 1950

Division advance Command Post Signal Jump team abandoned due to enemy action. Signal Detachment returned to Division Command Post. Photo teams dispatched to each RCT.

16 September 1950

Routine duties. All radio nets having difficulty moving traffic due to atmospheric interference.

17 September 1950

Radio interference subsided, radio nets normal. Relocated VHF terminals. Made arrangements send VHF team from Division Artillery to 38th RCT.

18 September 1950

Advance Signal Jump team departed to install new Division Command Post 2 miles south Changnyong on Yongsan-Changnyong Road. Made arrangements relocate DSSO at Changnyong. Made distribution 6 new SOI items.

19 September 1950

Closed out old Command Post (Ivanhoe) location at Maun-ni, closed in new Command Post 2 miles south Changnyong 1300. DSSO and Signal repair located at Changnyong.

20 September 1950 - Changnyong, Korea

Routine duties. Improving communication from Ivanhoe (Changnyong) to Ivanhoe Rear (Miryang).

21 September 1950

Received a radio teletype MRC-26 vehicle to maintain communications with army. Major Brunner made reconnaissance of area East Naktong river for new Division Command Post.

22 September 1950

WO/JG Augustine held duty 2d Signal Company assigned 702nd Ordnance Company. Signal Section briefed on future Division plans and communications required.

23 September 1950

Installed switchboard for trains area in Division QM at Changnyong. Arrangements being completed for Signal Jump team move to new location 5 miles west Naktong River.

24 September 1950 - Chogae, Korea

Received instructions for change of radio frequencies from Eighth Army. Signal Jump team departed to install Division advance Command Post 5 miles east of Chogae west of Naktong river. New Ivanhoe opened and old Command Post at Changnyong closed at 1500. Radio circuits only communication to regiments and Division Rear. 1 VHF circuit working to Division Trains (Changnyong).

25 September 1950

VHF circuits established to Divarty, 23rd and 38th RCT's. Units are moving too fast to keep in wire or VHF communications. Received orders to move Jump team early 26th. Requested 2 SCR-399 radios be furnished by army. Received negative answer due to unavailability of equipment. DSSO moved to Hyopchon.

26 September 1950 - Hyopchon, Korea.

Division Command Post moved to Hyopchon. 23rd and 38th RCT's too far forward to reach by wire lines. VHF from Division Command Post to Ivanhoe Trains (Changnyong) failed. Radio only reliable means communication, to any unit out of local area. Major Ted Kay reported for duty.

27 September 1950

Captain Copeland departed with Headquarters Commandant and G-1 to locate Command Post in Kochang area. Installed SCR-506 in General Bradley's truck. Signal Jump team dispatched to Kochang to install new Command Post.

28 September 1950

Plans changed in location new Command Post. Signal Jump team departed for Anui to install new Command Post. Radio Relay station remained at Kochang with 2d Medical Battalion to maintain communications between Division Advance (Anui) and Ivanhoe (Hyopchin). DSSO moved to Anui.

29 September 1950 - Anui, Korea

Closed Command Post at Hyopchin opened Ivanhoe at Anui. Unable to establish VHF communications between army and new Division Command Post due to distance. Radio communications unreliable to units. Wire impossible to maintain.

30 September 1950

Jump team moved to Chonju to establish new Command Post. As this move is 70 miles any communications except radio is doubtful. Division Command Post Anui will probably close 1 October. Plans made move DSSO and Signal Maintenance to Chonju 1 October 1950.

4. SUMMARY of OPERATIONS:

At the beginning of September the Division Command Post was located about 15 miles SW of Miryang on the Miryang-Yongsan road. The 9th RCT and Yongsan, Divarty and the 38th RCT about 8 miles north of Changnyong and the 23rd RCT in the vicinity west of Changnyong. Switchboards were maintained by the Division Signal section at Division Rear and Trains both located in Miryang.

Communications to Divarty and the 3 RCT's followed the Division MSR between Yongsan and Changnyong. When the Yongsan-Changnyong road was cut by the enemy wire communication was disrupted. Alternate wire routes could not be established due to the length of circuits which would require wire lines of over 30 miles to reach the 38th RCT.

Due to the mountainous country, VHF could not be used from subordinate Command Posts to the Division Command except by utilizing relay stations. A VHF relay station established on hill 593 working from the Division Command Post to Divarty solved this problem.

By using Divarty (Ivory) as a switching central for the 23rd RCT (Inspire) and the 38th RCT (Impel) reliable telephone communications was kept in to the units cut off north of Changnyong. Wire and VHF circuits were established between the Division Command Post and the 9th RCT (Index) located at Yongsan. Index served as a switching central for units south of the Yongsan-Changnyong road. This condition remained fairly static until about 18 September when the Division started advancing west of the Naktong River.

Due to distances involved and the mountainous terrain the Division FM Command net was useless and all radio traffic was handled on CW radio nets. To provide voice communications between Divarty and the Division Command Post an SCR-399 was set up at each headquarters.

As the Division moved west of the Naktong communications became more difficult. Wire lines were extended at first then all attempts to maintain wire lines to major subordinate units were disregarded and lines layed only to units in the vicinity of Division Headquarters.

VHF was moderately satisfactory. Circuits were established when terrain and Command Post movements permitted. VHF relay stations were installed where practical but as the division was crossing the Soebak mountain range it became more difficult to maintain communications by this method. As the advance continued elements of the division stretched from Miryang to Chonju a distance of 150 miles. By locating the two SCR-399 radio sets with Division Trains in Changnyong and the Division Command Post on its movement to be used as relay

stations radio communications was maintained. During the fast movement this was all the communications which was dependable between units.

Messenger service was used extensively throughout the month. It was slow due to crowded and poor road conditions but functioned without failure.

OPERATIONS CONCLUSION

(1) It was found that field wire was impractical in the type of terrain which the division fought over due to limited talking range and difficulty of maintaining circuits.

(2) VHF radio relay provided excellent telephone circuits when it could be installed. It was found that the TOCS allowance for a division signal company was inadequate as it provides only 6 terminal sets. A minimum of eight terminals and two relay stations could have been utilized.

(3) Radio communications was the only reliable means during fast moving periods. The SCR-193 radio sets used for the division command net were not powerful enough to furnish continuous operation when the Division was extended.

5. DIVISION SIGNAL SUPPLY AND MAINTENANCE ACTIVITIES

The Division Signal Supply originally set up at the Railroad at Miryang moved progressively to Changwong, Hyopshon, Anul and Chonju during the month. All Supplies being handled across country by truck from Miryang. At Chonju supplies were exhausted due to lack of transportation facilities to shuttle the 168 miles from Miryang.

During the period approximately 200 tons of Signal Supplies were furnished to Division units. Major items handled were:

- (a) Wire W-110 2000 miles
- (b) Wire W-110 1200 miles
- (c) Batteries, Dry 45,000
- (d) Radio Sets 240
- (e) Telephone switchboards 14
- (f) Panel Sets AP-50 49
- (g) Tool Equipment TR-33 110
- (h) Reel Equipment 64
- (i) Flashlights 250

Critical signal items were photo equipment, lineman equipment, telephones and field radios. Portions of all requisitions were filled except radio sets SCR-300 and AN/GRC-9 which were unavailable. A balance of 172 requisitions for radio sets remained at the end of the month. The Signal Maintenance traveled with the Division Signal Supply. With a very few exceptions all damaged equipment was repaired and returned to the using units during the period.

The section repaired a total of 390 items during the month.

6. SIGNAL PHOTO SECTION

During the month of September 3 teams of 3 Photographers each were attached to 3 RCT's, the 9th, 23rd and 28th. During this period approximately 60 packs of film were exposed and forwarded to HQ. In our laboratory approximately 20 film packs were processed for G2 and P10. One motion picture was released throughout the Division and expended approximately 3,500 feet of 35 MM Motion Picture film.

Highlights of this months operation were:

- (a) The complete coverage of the Nakdong River line and its subsequent crossing.
- (b) Hill 201 which was shot up for Division History, Still, Motion and Aerial.
- (c) The dedication of 2d Division Cemetery at Miryang, Motion and Still.
- (d) Coverage of atrocities by Sgt Tarr and his team attached to the 38th RCT.
 - (1) Still and Motion picture coverage of these atrocities were covered in the towns of Anul, Chonju and Kang-ju.

On September 28th Sgt Tarr, Pfc Gray and Cpl Mullin were ambushed while covering photographically the atrocities near Kang-ju. Result that all equip-

ment was lost except the vehicle. Photographer PFC Gray was wounded in both legs.

~~SECRET~~

Sgt Franklin during this period has flown 5 combat missions over the enemy lines making aerial views of the road nets to the North. Approximately 6 rolls of film were shot and 300 prints were delivered to G-2. The laboratory made documentary record of posters, leaflets and propanganda leaflets of North Korean literature for Division G-2. The laboratory processed approximately 720 pieces of film and distributed 3000 photo prints during the month.

OPERATIONS CONCLUSION:

Difficulties experienced during the month were:

(a) All Photographic material was in short supply which resulted in extreme conservation of film and prevented adequate coverage of all important action.

(b) Laboratory processing equipment issued to the Division Signal Company is of semi permanent nature not constructed for rapid movement and changes of location as required to keep up with Division moves. This equipment is deteriorating rapidly, especially air corps film dryer, K-20, aerial cameras and enlarging equipment.

E. F. Berendt

8 Inclosures:

- | | | |
|---|-----------------------------------|---------------|
| 1 | Historical report 2d Sig Co | E. F. BERENDT |
| 2 | Radio & Wire Tfc Diagram 3 Sep 50 | Lt Col Sig C |
| 3 | Circuit Diagram 10 Sep 50 | Div Sig O |
| 4 | VHF Circuit Diagram 16 Sep 50 | |
| 5 | Tfc Diagram 16 Sep 50 | |
| 6 | Tfc Diagram 21 Sep 50 | |
| 7 | Circuit Diagram 25 Sep 50 | |
| 8 | Circuit Diagram 30 Sep 50 | |

SECOND SIGNAL COMPANY
Second Infantry Division
APO 248

HISTORICAL REPORT OF 2D SIGNAL COMPANY

From 1 September 1950 to 30 September 1950

- 1 September 1950: Company moved from DQ 5625 back to old site at Fugong-Myon DQ 8919. Enemy mortar fire falling 100 yards short of road Company was moving on.
- 2 September 1950: No change.
- 3 September 1950: No change.
- 4 September 1950: Two (2) men wounded in action, Pfc Joseph D. Barnett, RA 14316383 and Pfc Benny Bischoff, RA0957931, wounded while maintaining communications for the Infantry Regts near Yangson, Korea by mortar fire.
- 5 September 1950: Unit moved acrossed the river to higher ground, was impossible to move in wet weather at other position. Sgt Andrew F. Edge, RA12026166, wounded in action while maintaining communications near the Division Command Post. Pfc Elvin L. Marshall, RA37014887, and Pfc Manuel E. Martinez were in Sgt Edge's team, gave him 1st Aid until removed to the Aid Station.
- 6 & 7 September 1950: No change.
- 8 September 1950: Pfc Benny Bischoff, RA0957931, was returned to duty after being hospitalized for wounds received in action on the 4th of September 1950.
- 9,10,11,12 & 13 September 1950 No Change
- 14 September 1950: Unit entrucked from Fugong-Myon to Tochohni.
- 15 September 1950: Unit entrucked from Tochohni to old site at Fugong-Myon.
- 16 September 1950: Pfc Julio V. Lopez, RA13639169, wounded by self-inflected wound in left side of chest with 45 Cal Sub-machine gun.
- 17 & 18 September 1950: No change
- 19 September 1950: Unit entrucked from Fugong-Myon to Sindong-ni DQ 5528.
- 20,21,22 & 23 September 1950: No change.
- 24 September 1950: Unit entrucked from Sindong-ni to Chunghae DQ 3633. Cpl Ernest L. Fickerns, RA19293966 and Cpl Andrew C. Warhurst Jr,

Incl: #1

SECRET

SECRET
captured PW in the 23rd Infantry Sector after PW had fired upon the two (2) men. PW was brought to the 2d Signal Company Command Post, Captain Cass J. Jozwiak, Company Commander, instructed the men to take the PW to the Military Police.

- 25 September 1950: No change.
- 26 September 1950: Unit entrucked from Chunghae DQ 3633 to Hyopchon DQ 3425.
- 27 September 1950: No change.
- 28 September 1950: Unit entrucked from Hyopchon DQ 3425 to Anui CQ 9343.
- 29 September 1950: No change.
- 30 September 1950: Unit entrucked from Anui DQ 9343 to Chenju DQ 3365. 16 prisoners picked up by Unit while traveling to Chenju, PWs turned over to the Military Police, and patrols of the 23rd Inf Regt.

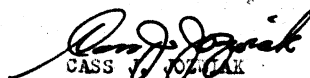
CASS JOZWIAK
Capt Sig C
Commanding

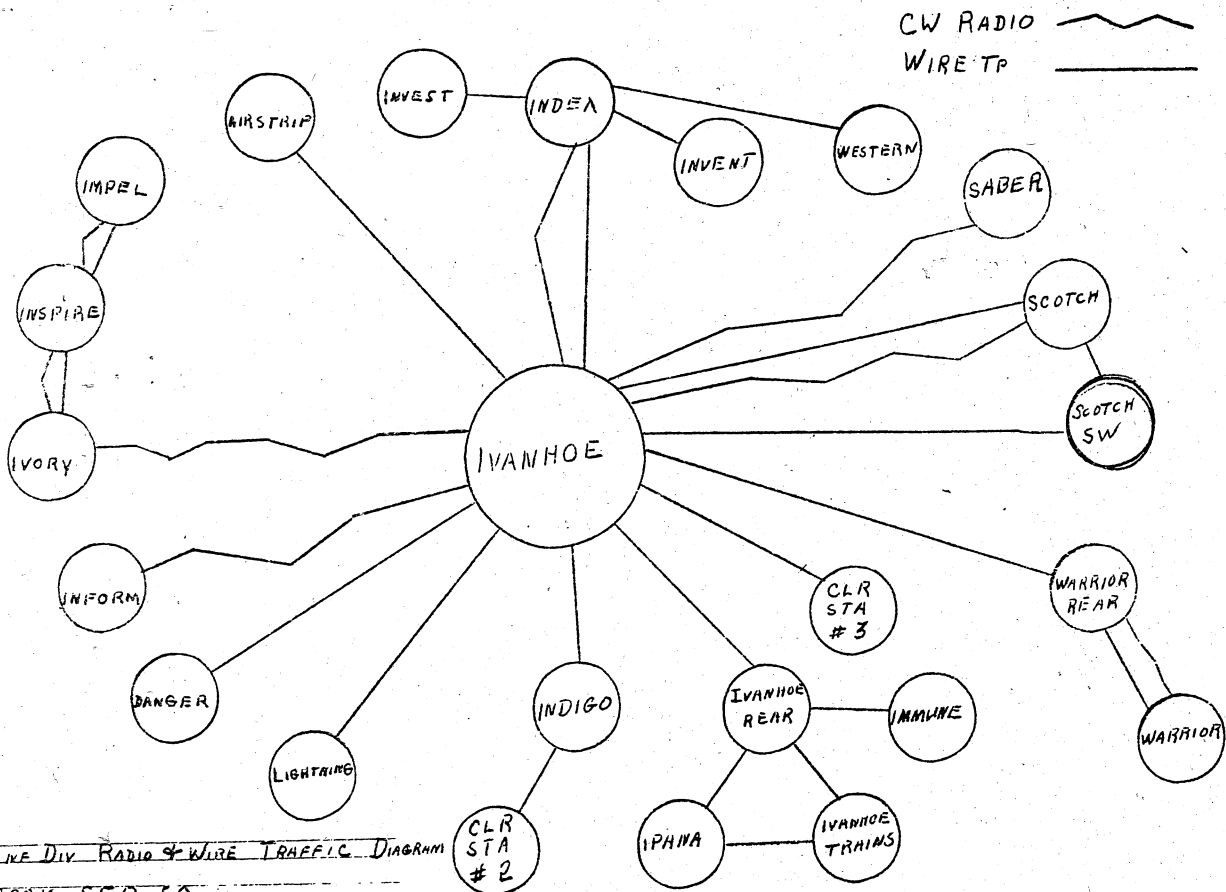

2nd LINE DIV. RADIO & WIRE TRAFFIC DIAGRAM
 031200K SEP 30

Incl: #2

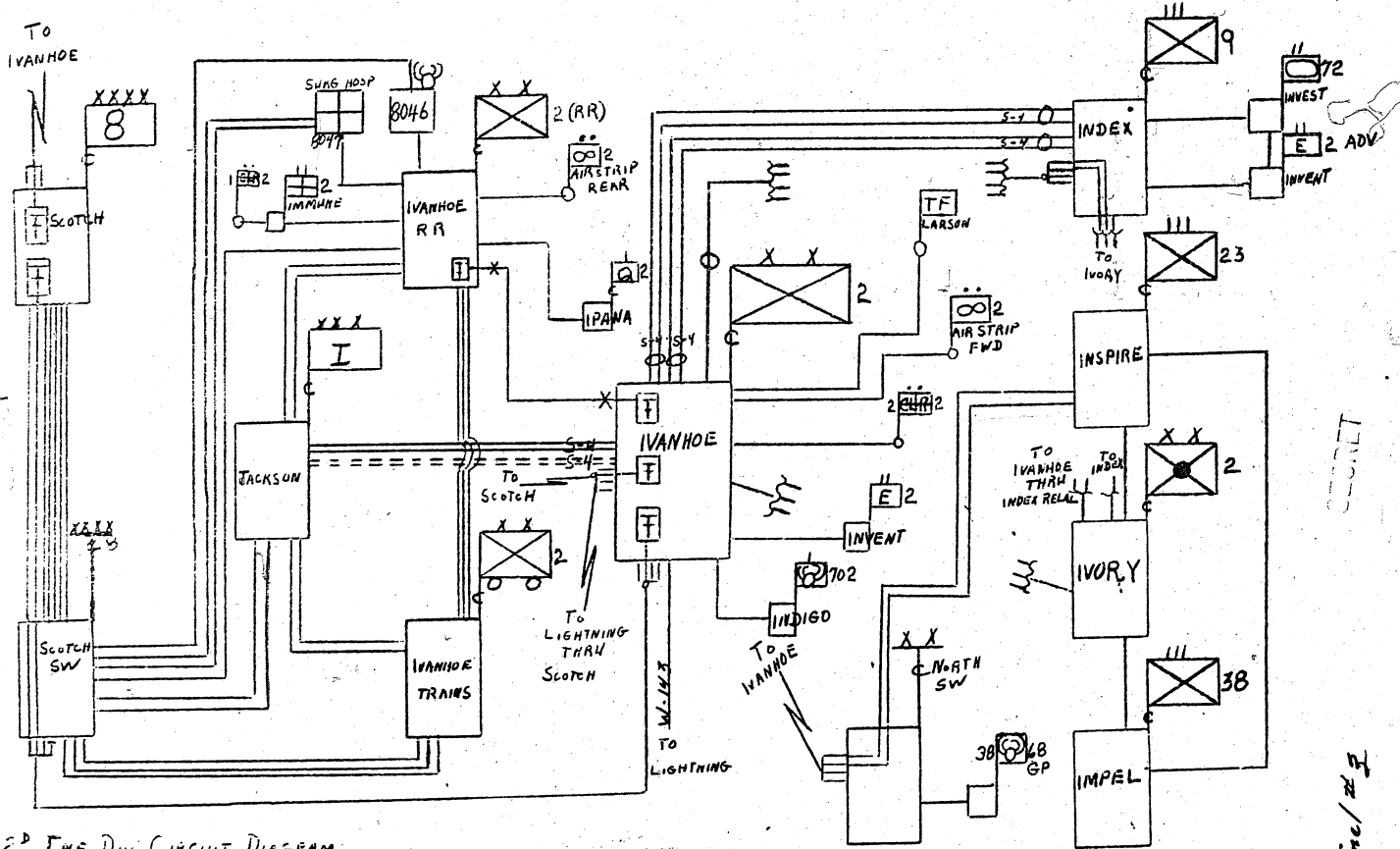

2^D IWF DIV CIRCUIT DIAGRAM

10 SEP 50

100-100

Incl # 2

2nd INF DIV VHF CIRCUIT DIAGRAM
AS OF 16-SEP-50

HILL 693
ARMY DELAY
TEAM

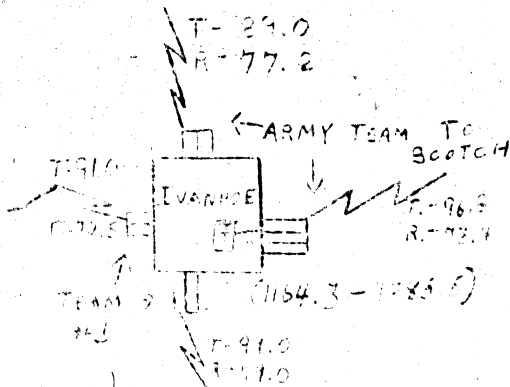
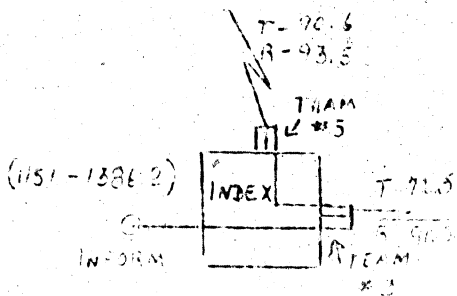
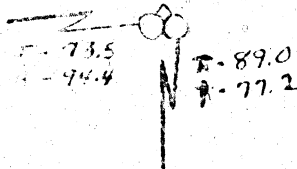
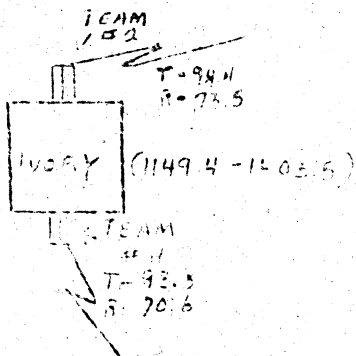

TO LIGHTNING

Edward J. Hinkle
1st Lt Sig Co

Incl # 4

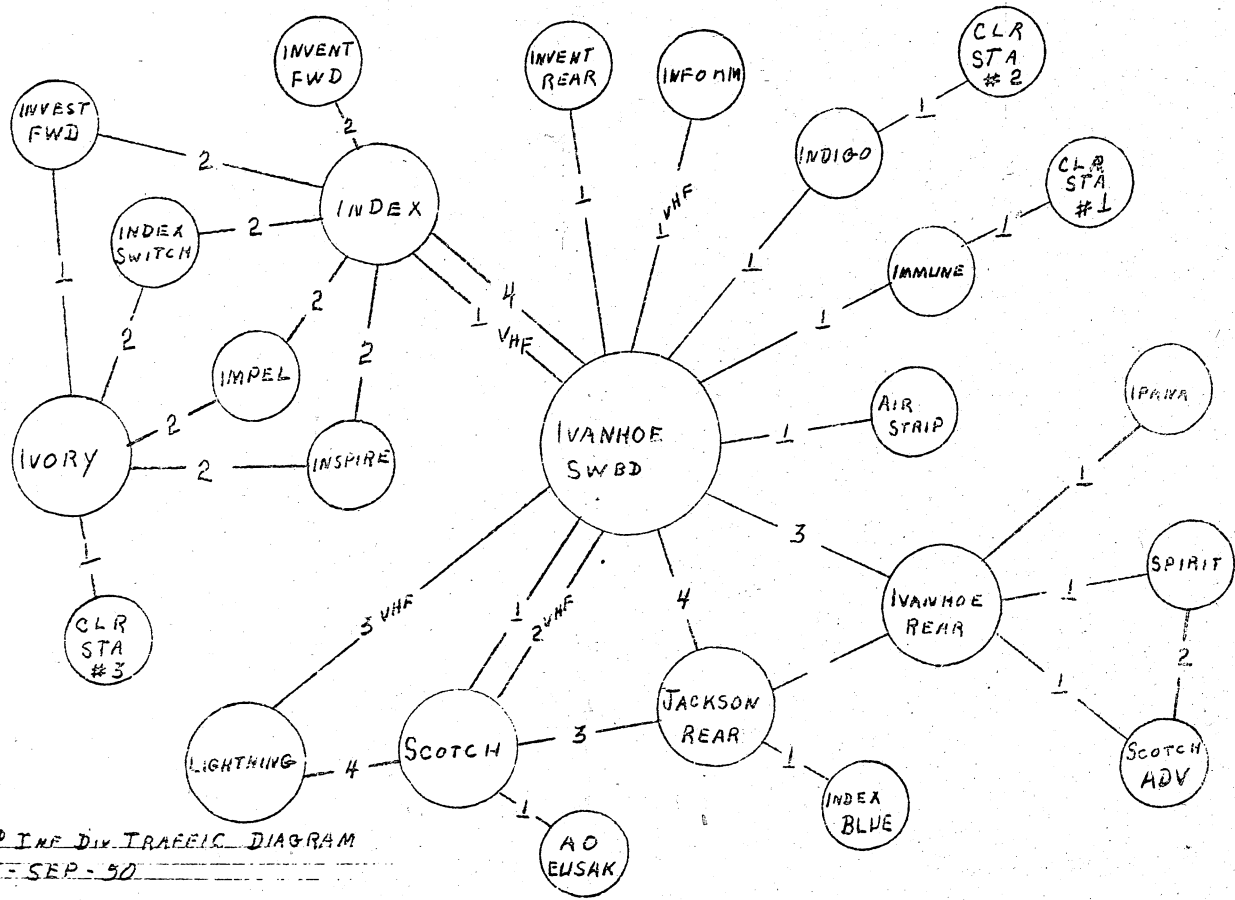

20 INF DIV TRAFFIC DIAGRAM
 16-SEP-50

Incl. #5-

2nd INF DIV TRAFFIC DIAGRAM

211900 SEP 50

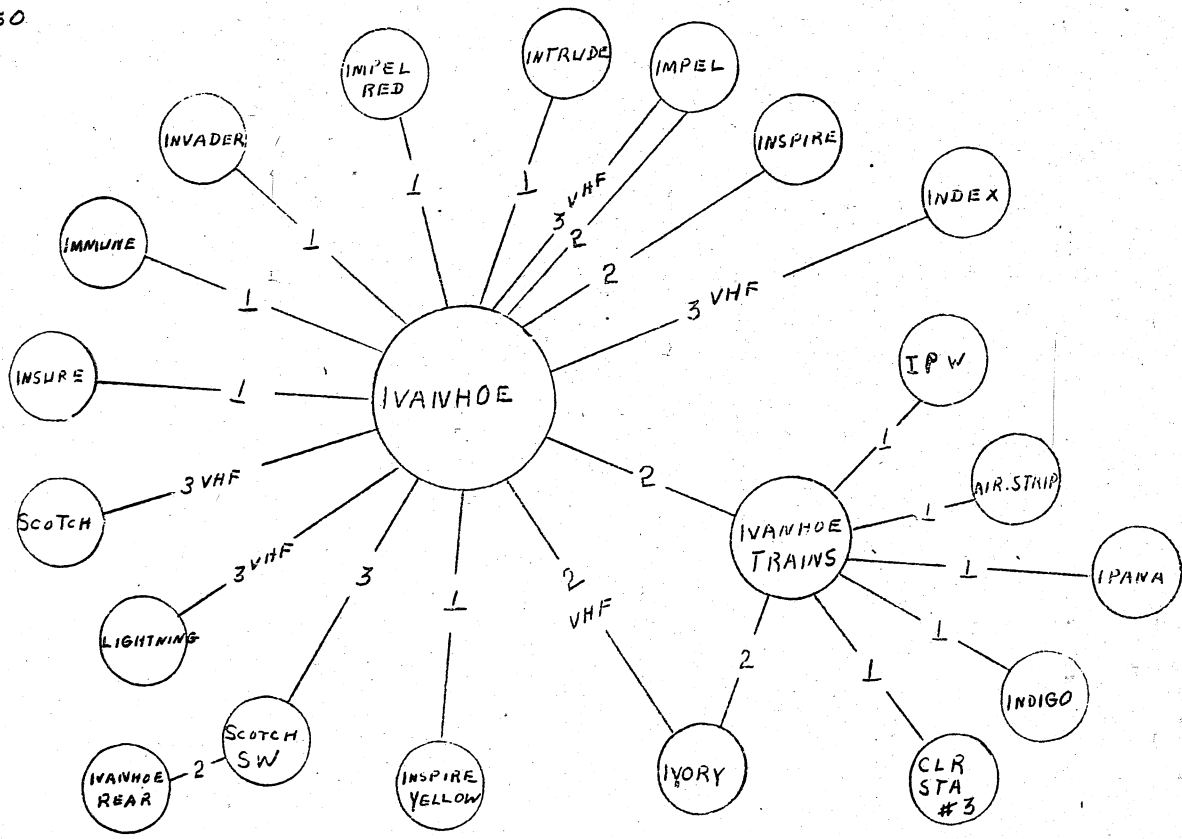

SECRET

Incl #6

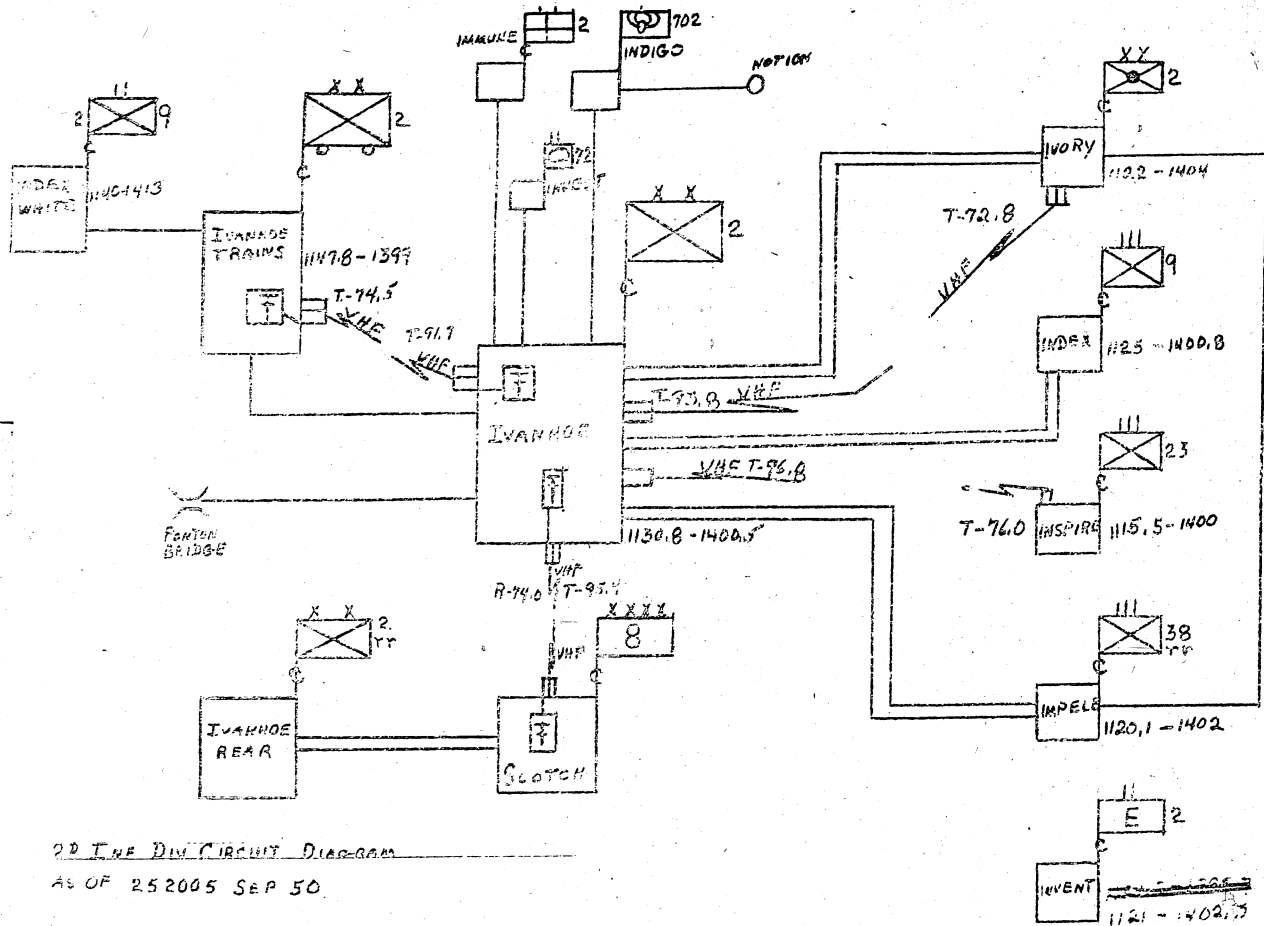

22 LINE DISTRIBUTION CIRCUIT DIAGRAM

AS OF 25 2005 SEP 50

1115

Incl. #7

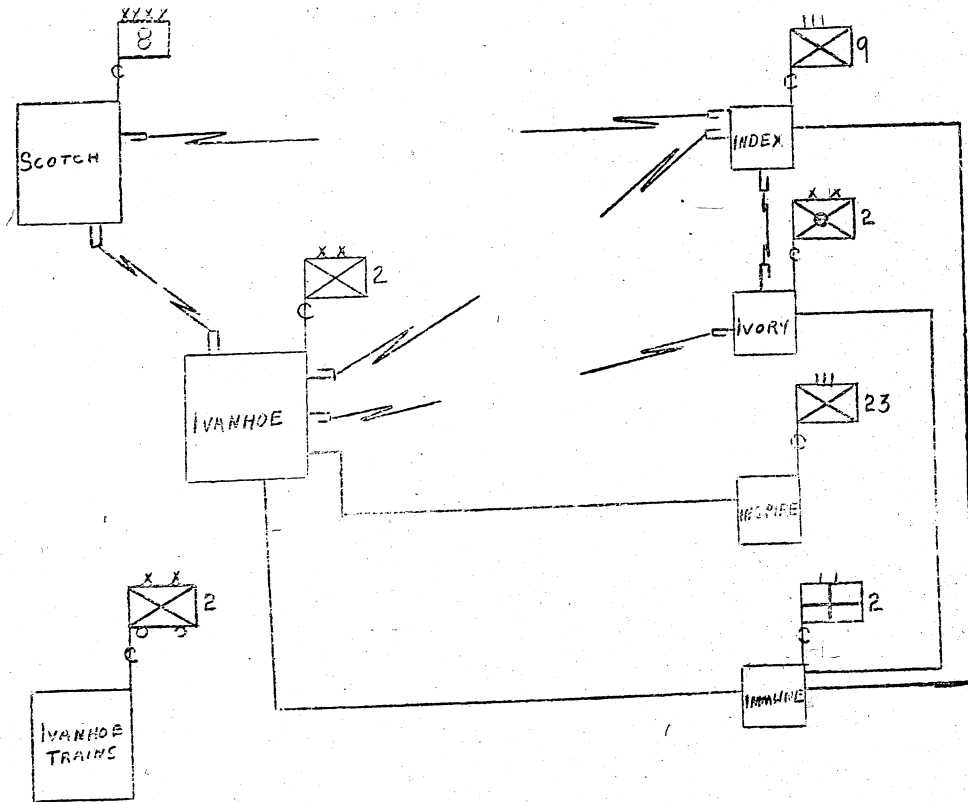

2nd INF DIV. CIRCUIT DIAGRAM
 AS OF 0800 30 SEP 50

SECRET

Incl #8

HEADQUARTERS
2d Infantry Division
APO 248 % Postmaster
San Francisco, California

Transportation Section Historical Narrative Report
Period: 1 - 30 September 1950

During September 1950 the Transportation Section, 2d Infantry Division continued to supervise and report incoming rail shipments to Division railheads.

Four hundred eighty-three (483) rail cars were received and cataloged.

The Transportation Officer supervised the procurement of necessary rail equipment for outgoing shipments.

The 60th TC Truck Co, 1 platoon of the 541st TC Truck Co and 1 platoon of the 74th TC Truck Co, comprising the equivalent of two truck companies, supported the division during this period. The supply lines were extended from 20 miles to approximately 330 miles over rough and treacherous roads. The operation of the truck companies was made doubly hard by one way passages and one way bridges on supply routes. Trucks were utilized for tactical movements and were used 100% daily.

Deadline of vehicles were kept to a minimum by the establishment of production line maintenance and inspection. At the completion of every trip of 50 miles or over, vehicles were inspected and preventative maintenance was performed.

Three vehicles were lost directly attributable to combat.

Due to the great distances the Division moved on short notices and the rapidity of their advance, the consumption of Class III greatly increased.

At the end of the period the railhead was 165 miles from the point of issue which necessitated a 330 mile turn around.

During the period of this highly successful offensive operation, it was necessary to expend every effort for the expediting of special supplies to facilitate the success of the operation.

Twenty one (21) DUKW's were assigned in support of the Division and were used tactically for the initial crossing of the NAKTONG.

The DUKW's were assigned by Army from the 3rd Transportation Corps Amphibious Truck Co and their manner of performance under most harassing conditions was excellent, several were lost due to shell fire and two drivers killed and four wounded.

Transportation Section Historical Narrative Report - Cont'd
Period: 1 - 30 September 1950

To the already overworked support troops due to over extended supply lines the burden of transporting POW's was added. These POW's became a problem of increasing importance as the number increased because Army failed to make any provision for their disposition. Several truck loads were refused at the railhead and were re-hauled to other locations.

During this period the G-4 Transportation Officer, in conjunction with G-3 and Provost Marshal, established road priorities for movements of units and maintained convoy discipline. Strict priorities and convoy discipline was necessitated by having available, to the Division, only one MSR.

During the whole period, convoy operation was harassed by enemy established road blocks and practically every convoy was exposed to enemy small arms fire.

CONFIDENTIAL

HEADQUARTERS
2d Infantry Division
APO 248
Office of the Division Signal Officer

7 November 1950

SUBJECT: Narrative History

TO : Commanding General
2d Infantry Division
APO 248
ATTN: G-2

1. MISSION:

- a. Provide signal communication for division headquarters to include communication to units operating directly under division headquarters.
- b. Provide photography signal supply and field maintenance of division signal equipment.

2. CAPABILITIES:

- a. Staff planning supervision of communication training and other signal activities.
- b. Wire and radio communication to units directly under division headquarters.

c. Teletypewriter service.

d. Limited Radio Relay operations.

e. Messenger and runner service for division headquarters.

2. Signal Supply and Maintenance of Signal Corps
Equipment.

g. Still and motion picture equipment and slide processing still pictures.

h. Providing limited number of motion picture and slide projectors.

3. DAILY JOURNAL ENTRIES SUBJECT MATTER.

CONFIDENTIAL

CONFIDENTIAL

1 October 1950: Chonju, Korea

Advance Signal Team establish Ivanhoe advance installation at Chonju. Local lines were run to Divarty. Radio communication only means to 38th RCT at Nenson, 23rd RCT at Anui, and 9th RCT at Myecheon. Communication lost with Division Head at Kkyang. Old IV closed at 0910. Signal Officer arrived now Ivanhoe CP Chonju 1510.

2 October 1950: Chonju, Korea

Established lateral VHF circuit to 25th RCT (lighting). VHF circuit to 38th RCT (Impel). Radio traffic heavy, no additional channel yet established to handle 9th & 23rd RCT's which have no other communications to Division Headquarters.

3 October 1950: Chonju, Korea.

9th RCT moving vicinity of Chonju. Continue operate 2d Command Net. Open second radio net to IX Corps. Improving local wire circuits. ESO reports wire exhausted, no replacement available. Ivanhoe trains switchboard installed Chonju. VHF circuit installed Ivory to Ivanhoe.

4 October 1950: Chonju, Korea

Closed second IX Corps radio net. IX Corps moved to Chonju. Wire circuits established Reapest (IX Corps) to Ivanhoe. 2 wire lines established to 23rd RCT.

5 October 1950: Chonju, Korea

Asst Signal Officer departed vicinity Suwon with Hq Comdt & Asst G-1 to locate new Division CP. Radio traffic continues heavy. Hq IX Corps moved to Taejon.

6 October 1950: Chonju, Korea

Three messengers, Cpl Pickens, Cpl Ashurst and Oh Yong Suk (ROK Soldier) ambushed by enemy while on messenger run to 9th RCT near Chirun, Korea. Oh Yong Suk, KIA; Cpl's Pickens and Ashurst KIA. Pfc Kay, Photo section ambushed near Nangun; by enemy, Pfc Gray KIA. Radio traffic decreasing.

7 October, 1950: Chonju, Korea

Signal jump team consisting of 1st Division Signal Officer, Maj Brunner, T&T, Construction, Radio, Messengers, and VHF sections departed for Suwon. Bivouaced with 38th RCT vicinity of Konju.

8 October 1950: Chonju, Korea

Plans made close out CP at Chonju 8th and 9th October. Advance team set up 4 miles north of Konju with VHF circuit to Ivanhoe. Maj Kay departed with

CONFIDENTIAL

CONFIDENTIAL

portion of Signal Company for Division assembly area vicinity Suwon-Seoul.

9 October 1950: Chonju, Korea.

Capt Jessick departed for Advanced CP with 5 vehicles and 25 PM. Maj Kay and jump team closed advance CP at Kaju and moved overnight bivouac at Suwon. Installed temporary switchboard and local CP telephones.

10 October 1950: Noryang-jin, Korea.

DSO and DSSO closed out CP at Chonju, moved to new CP established at Noryang-jin near Seoul. DSSO & Maintenance Section set up at Suwon. All units moving to assembly area vicinity Seoul-Tongt. Radio only communication established.

11 October 1950: Noryang-jin, Korea.

Established VHF circuit Ivanhoe to Scotch (Seoul), wire lines to Impel (38th RCT) and Indigo (702nd Ord). Radio traffic very heavy. Following nets operating, IX Corps, 2 Division Command and Division administrative net.

12 October 1950: Noryang-jin, Korea.

Installed 2 wire circuits to Ivory (Divarty) near Anyang-ni.

13 October 1950: Noryang-jin, Korea.

Installed VHF circuit from Ivanhoe to Ipara (Division QM) at Suwon to serve units in trains area, and VHF circuit Ivanhoe to Ivory. Wire lines layed to Inspire (23rd RCT) and Invest (72nd Tank). Division Rear closed out at Chonju departed for Ivanhoe.

14 October 1950: Noryang-jin, Korea.

Division Rear signal detachment, (DFO Section in charge) arrived Ivanhoe. DSO held meeting of all communications officers. Division units to discuss supply shortages and maintenance of equipment.

15 October 1950: Noryang-jin, Korea.

Radio traffic decreasing to extent all Division Nets put on standby basis. Radio equipment being overhauled.

16 October 1950: Noryang-jin, Korea.

Closed out of IX Corps net entered I.M.F. radio net.

17 October 1950: Noryang-jin, Korea.

Inspection and maintenance of equipment.

CONFIDENTIAL

CONFIDENTIAL

18 October 1950: Noryang-jin, Korea.

Continue maintenance of equipment. Improving wire circuits to units in assembly area.

19 October 1950: Noryang-jin, Korea.

DSSO and Division OH moved from camp 2 miles west of Division Headquarters on Incheon Road.

20 October 1950: Noryang-jin, Korea

VHF from Ivanhoe to Ivanhoe Trains closed out.

21 October 1950: Noryang-jin, Korea.

23rd RCT closed out. Departed Sariwon area. Radio communications to unit.

22 October 1950: Noryang-jin, Korea.

Lt Simons departed for Sariwon to install TC-4 switchboard for General Bradley. Took 10 EM and 1 TC-4 switchboard. Telegraphic orders received from EUSAK to transfer Capt C. I. Barr from 2d Signal to KMAG.

23 October 1950: Noryang-jin, Korea.

Capt Barr relieved DSSO, Maj Kay appointed DSSO.

24 October 1950: Noryang-jin, Korea

Preparing move jump team to Sariwon to establish Division advance CP.

25 October 1950: Noryang-jin, Korea

Maj Brunner with Signal Jump team 4 officers 60 EM departed 0800 for Sariwon, arrived Sariwon 1815.

26 October 1950: Noryang-jin, Korea

Ivanhoe-Scotch VHF circuit dismantled. 2 wire circuits installed Scotch-Ivanhoe simplex for 1 tele. circuit. 24 Techs departed for Sariwon with 3 switchboard operators.

27 October 1950: Noryang-jin, Korea

2 officers and 67 EM 16 vehicles and 1 company departed for Division advance P'yongyang. Advance CP will open 0700 28 October at Ivanhoe.

28 October 1950: Noryang-jin, Korea

Ivanhoe advance became Ivanhoe at 0400. Old Ivanhoe at Noryang-jin closed at 0400 became Ivanhoe B. 6 officers 145 EM closed out company and signal installations. 1300 DSO Party arrived

CONFIDENTIAL

CONFIDENTIAL

Saridon for overnight bivouac.

29 October 1950: P'yongyang, Korea

0830 DSO Party departed Saridon arrived P'yongyang 1100.

30 October 1950: P'yongyang, Korea

Established VHF circuit from Ivanhoe (P'yongyang) to Index white (Chin-nanip'o).

31 October 1950: P'yongyang, Korea

Lt Melbourne arrived with 3th Army VHF crew to establish VHF link Ivanhoe to Scotch. Signal officer and Lt Hawk departed for Saridon to relocate Division switch and VHF relay station.

4. SUMMARY OF OPERATIONS

As the month of October opened the 2d Infantry Division was concluding its rout of the enemy across the Soback Mountain range between the Nakdong River and the city of Chonju, Korea.

Division Headquarters was closing in at Chonju, the 38th RCT moving rapidly northward from Chonju toward Honsan, the 23rd RCT at Chinan, 70 miles south of Chonju, the 9th RCT at Hyopohin, Divarty on the move to Chonju and Division Rear was located at Miryang preparing to move to Chinju on the southern coast of Korea. The 65th RCT (Porto Rican) was located at Changnyong a dozen miles east of the Nakdong River.

In all the signal section was trying to maintain communications to division elements over a distance of 200 miles. SCR-300 radios were used at Division Headquarters and Changnyong as relay stations for the small radio sets of units located out of normal range to Division Headquarters.

During this phase, while elements of the Division were assembling in the Chonju area, CW radio was only means of communications between Division Headquarters and subordinate Headquarters as well as in the Chonju assembly area telephone circuits were established to Division Headquarters either by VHF, field wire or a combination of both. By the seventh of October telephone facilities were available to all Division units except the 9th RCT located at Anui, 70 miles south of Chonju and Division Rear located at Chonju. These two headquarters were served by radio only.

About this time the division was ordered to assemble in the Suwon-Seoul area. Division Headquarters moved to Yeu-an-jin south of Seoul 10 October. The DSSO was located at Suwon. Elements of the Division continued to arrive in the area, until 14 October when the Division had moved up.

During this movement radio was again the main stay for communications and traffic hit an all time high mark of 122 messages handled by the 2d Signal Company radio section in one day.

CONFIDENTIAL

CONFIDENTIAL

From 14 October until 24 October communication problems for the section were simple. All units were located within a 20 mile radius of Division Headquarters and wire communication was easily maintained. This stable period was used to overhaul the 2d Signal Company's signal equipment, replenish supplies and hold personnel inspections.

Division units started moving from the Seoul area about the 20 October. On 21 October the 23rd RCT departed for the Sariwon area. Communications between the 23rd and Division Headquarters was maintained by radio. On 22nd October Lt Simons departed for Sariwon and installed a switching central to serve units in that area. An advance team followed on the 25th to establish Division Headquarters in Sariwon. The advance team moved to P'yongyang where the Division CP opened at 1400 hours on 28 October. On that date the Sariwon switch continued in operation. The old CP at Noryang-jin was closed out and turned over the Division Rear. By the end of the month the Division was again strung out over a 200 mile distance, however terrain and the tactical situation favored communications. Communications from Division Headquarters (P'yongyang) to Division Rear was over army VHF facilities furnishing both telephone and teletypewriter service. The Division Rear switchboard served as a switching central for Divarty, 38th RCT, 72nd Tank Bn and 2d Engrs all located in the vicinity.

A VHF circuit from P'yongyang to Sariwon terminated in a switching central at Sariwon serving supply units in that area. This switch relayed telephone traffic to 23rd RCT units located between Sariwon and Haeju by a connecting VHF system and open wire lines from Division Headquarters to Headquarters 23rd RCT at Haeju. The total length of this circuit, 90 miles was the longest telephone circuit which we were able to successfully maintain during the campaign.

CONCLUSION:

During the month 2d Signal Company radio stations serving Division Headquarters handled 3147 messages on its nets. The wire section installed switch boards at seven locations, made 400 separate telephone installations averaged 365 calls per day for a total of approximately 11000 calls for the month.

Wire construction teams layed 560 miles of telephone line, both new and recovered field wire were used. Message center handled 4123 messages of all types. Coded groups amounted to 135,493. Messenger service totaled 10,600 vehicle miles during the month on daily messenger runs. The longest daily run of the month was from Division Headquarters at P'yongyang to Division Rear at Seoul, a distance of 190 miles.

VHF radio-relay telephone links were established to the full extent of our equipment. Due to the fairly flat coastal country between Chonju and P'yongyang VHF telephone circuits were operated between Headquarters up to fifty miles apart. These circuits provided reliable communications far in excess of the divisions wire capability.

CONFIDENTIAL

5. PHOTOGRAPHIC ACTIVITIES.

The Photo section did very little official Photo coverage during this period.

Most important photo missions were:

- a. Task Force Indragrad. (Classified mission-NK Capital Piyongyang)
- b. Still and motion picture coverage of 17 battle field commissions in the 38th RCT.
- c. Training phase of ROK's and American soldiers.
- d. PIO coverage of 2d Infantry Division.

Total amount of 35 MM motion pictures shot	800
Total amount of 4X5 still film shot	240
Total amount of 4X5 prints made	1200

Extensive campaign of maintaining of Photo equipment took place during this period.

6. DIVISION SIGNAL SUPPLY AND MAINTENANCE ACTIVITY:

The Division Signal Supply and Maintenance Sections located at Chonju on 1 October moved to Wonsan on 10 October and thence 2 miles west of Yeng-dong-Pe on the Seoul-Inchon highway on the 19th October where it remained for the balance of the month. Previous to moving into the Suwon area signal Supplies furnished from the railroad at Miryung were critical due to long overland trip required. Wire and batteries were the items effected most. Upon arrival in the Seoul area, all items became available at Ascom City (near Inchon) and all units were brought up to strength on wire, batteries and the majority of items consumed or lost during the previous six weeks of combat.

Major items issued during the period:

- a. Wire, W-110, W-130 and W-143 - 547 miles
- b. Batteries, dry - 49000. This was an increase of 10% over the month of September.
- c. Radio Sets - 60
- d. Flashlights - 271
- e. Panel Sets, AP-40 - 211
- f. Telephones EM-9 - 112
- g. Emergency Switches and SR-18 - 31
- h. Handset, TS-10 - 62

Items which were unavailable or were in short supply were photographic equipment and supplies, radio sets SCR-300, SCR-519 and AN/GRC-9, tool equipments all types, lanterns, and power units PE-210.

During the month the maintenance section evacuated to army supply 5 tons or approximately 550 pieces of salvage and captured signal equipment and repaired and returned to using units 444 pieces of signal equipment.

CONFIDENTIAL

● **CONFIDENTIAL** ●

7. 2D SIGNAL COMPANY ACTIVITIES

- 1, 2, 3 October 1950: No change.
- 4 October 1950: Cpl Ernest M. Pickens, RA19293966, Cpl Andrew C. Warhurst Jr., RA37699563, and Oh Yong Suk, (ROK Soldier) while returning from a message run from 9th RCT and 65th RCT were ambushed by North Koreans. Cpl Pickens was SMIA, Cpl Warhurst was LWIA, and Oh Yong Suk (ROK Soldier) KIA. Ambush took place near Chinan, Korea. Pfc Rolland D. Gray, RA17267475, 2d Signal Co Photo team, while taking pictures was ambushed by North Korean Soldiers near Hansang, Korea. Pfc Gray was LWIA.
- 5, 6, 7 October 1950: No change.
- 8 October 1950: Unit entrucked from Chonju to Konghu, Korea.
- 9 October 1950: Unit entrucked from Kongju to Ulsong-Ni, Korea.
- 10 October 1950: Unit entrucked from Yulchong-Ni to No Ryung Chin, Korea.
- 11, 12, 13 October 1950: No change.
- 13 October thru 29 October 1950: No change.
- 30 October 1950: Unit entrucked from No Ryung Chin to P'yongyang, Korea, the North Korean Capital.

8 Inoclosures:

- 1 Circuit Diagram 2 Oct 50
2 Circuit Diagram 4 Oct 50
3 Circuit Diagram 13 Oct 50
4 Circuit Diagram 14 Oct 50
5 Strip Map 26 Oct 50
6 Circuit Diagram 31 Oct 50
7 VHF Circuit Diagram 31 Oct 50
8 Radio Circuit Diagram 31 Oct 50

E. F. Berendt
E. F. BERENDT
Lt Col Sig C
Div Sig O.

CONFIDENTIAL

CONFIDENTIAL

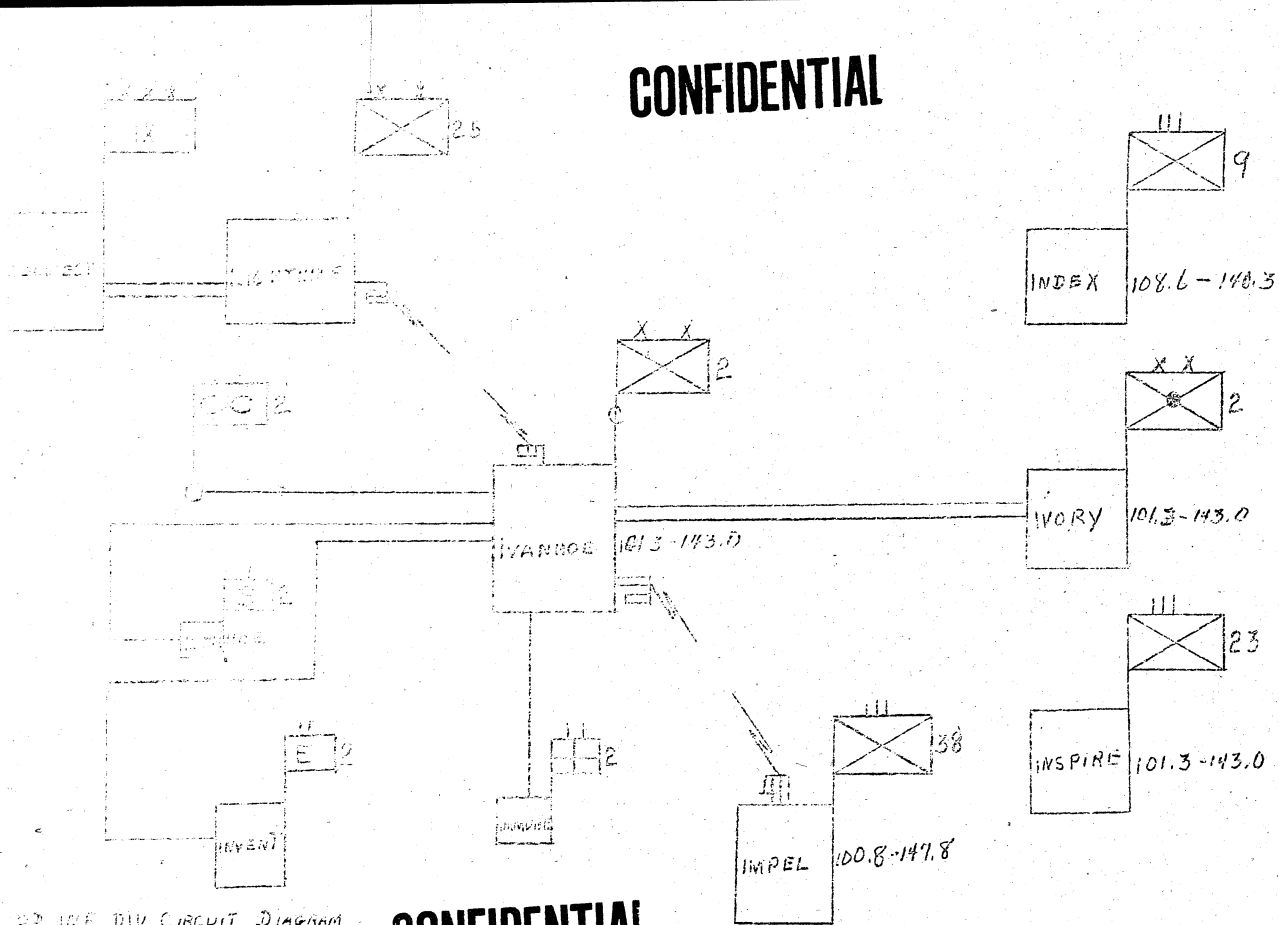

2ND INF DIV CIRCUIT DIAGRAM
AS OF 0890 2 OCT 50

CONFIDENTIAL

CONFIDENTIAL

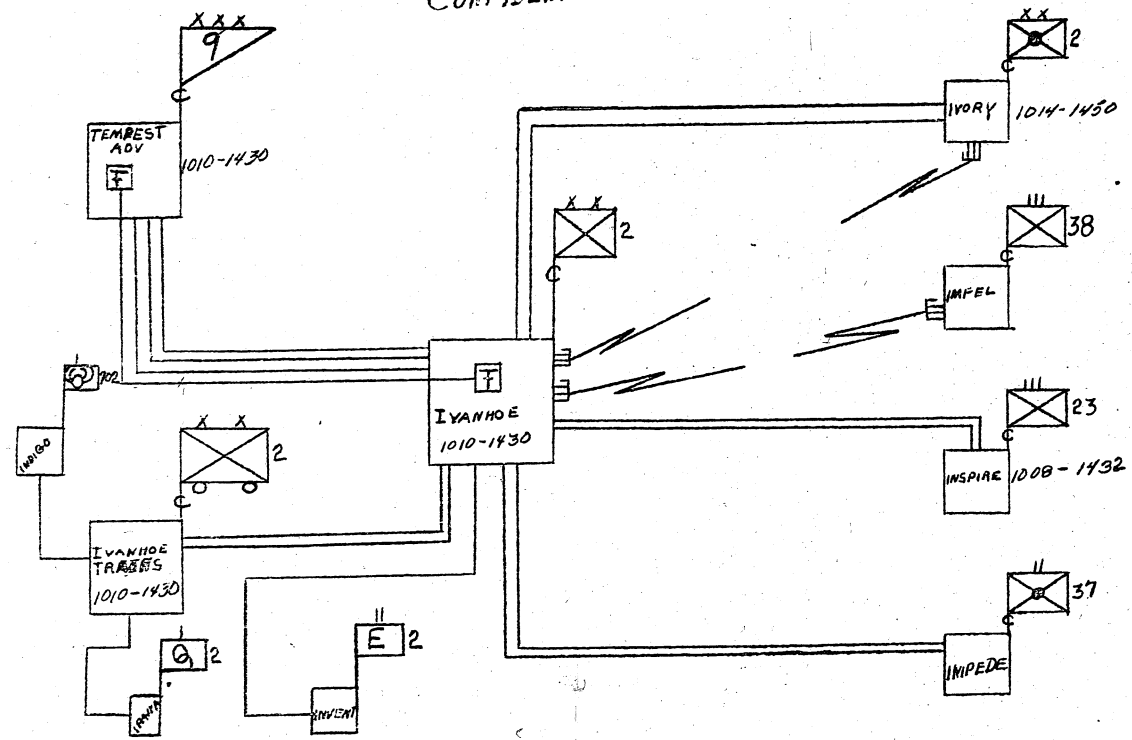

2nd INF DIV CIRCUIT DIAGRAM

AS OF 040800 ~~SEP~~ 50
OCT 8

CONFIDENTIAL

CONFIDENTIAL

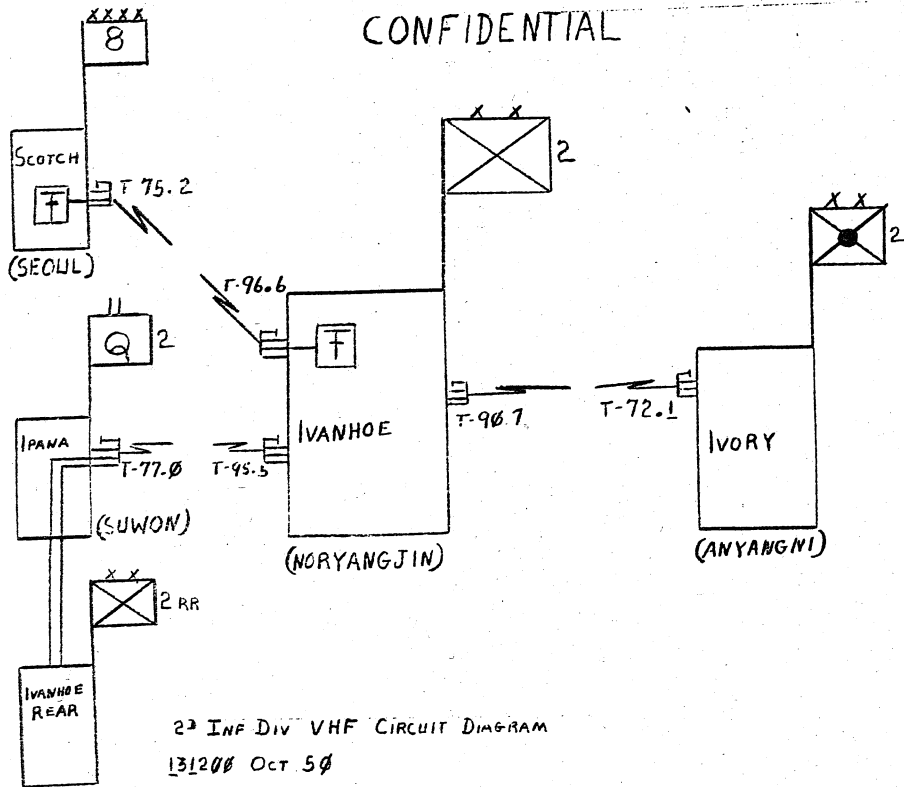

2nd INF DIV VHF CIRCUIT DIAGRAM
131200 OCT 50

CONFIDENTIAL

Edwin J Hawk
1st Lt Sig C
Radio Relay Co

CONFIDENTIAL

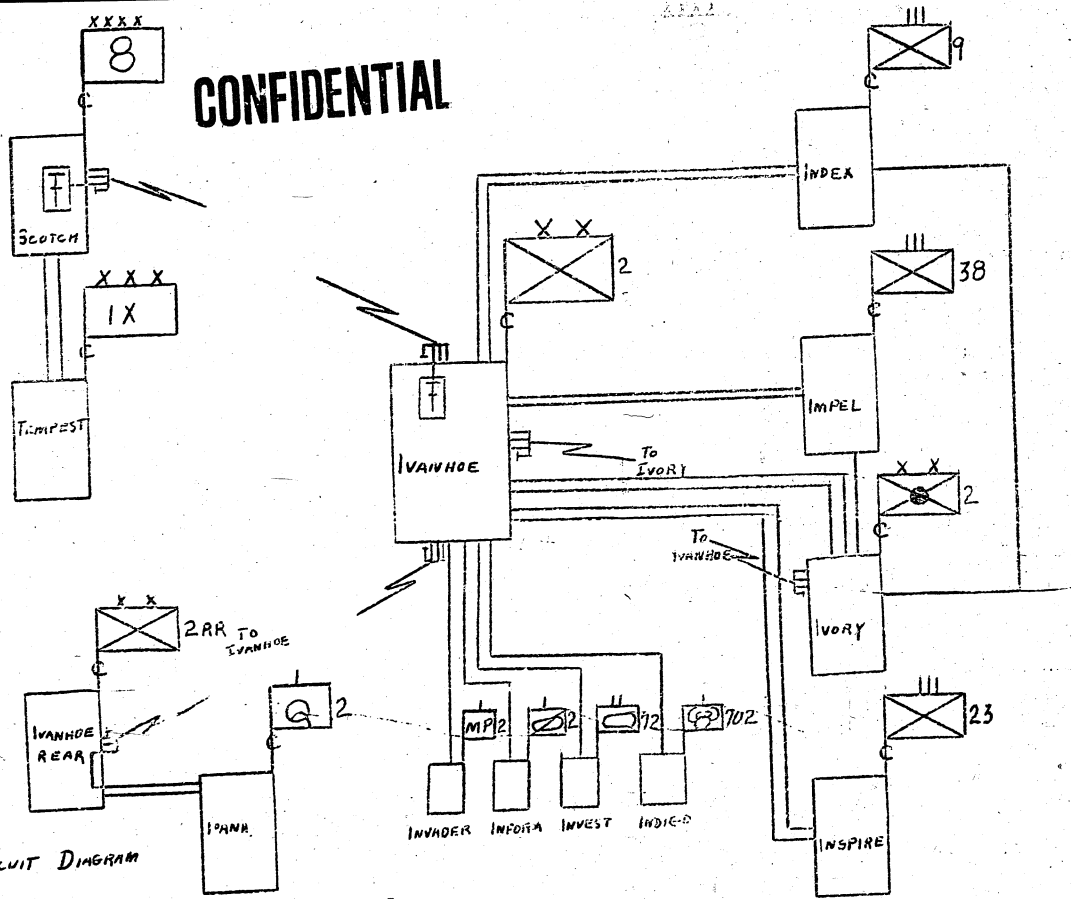

2nd INF DIV CIRCUIT DIAGRAM
 14 Oct - 50

CONFIDENTIAL

CONFIDENTIAL

X Pyongyang

15

X Chongryon

15

X Chongju

17

X Capwon

X Sinak

19

X Anson

16

X Kaesong

18

X Musan

20

"Strip Map" to
Assessory Movement
Order. 1st 2d Inf Div
26 Oct 50

CONFIDENTIAL

001

CONFIDENTIAL

2³ INF DIV CIRCUIT DIAGRAM
31 OCT 50

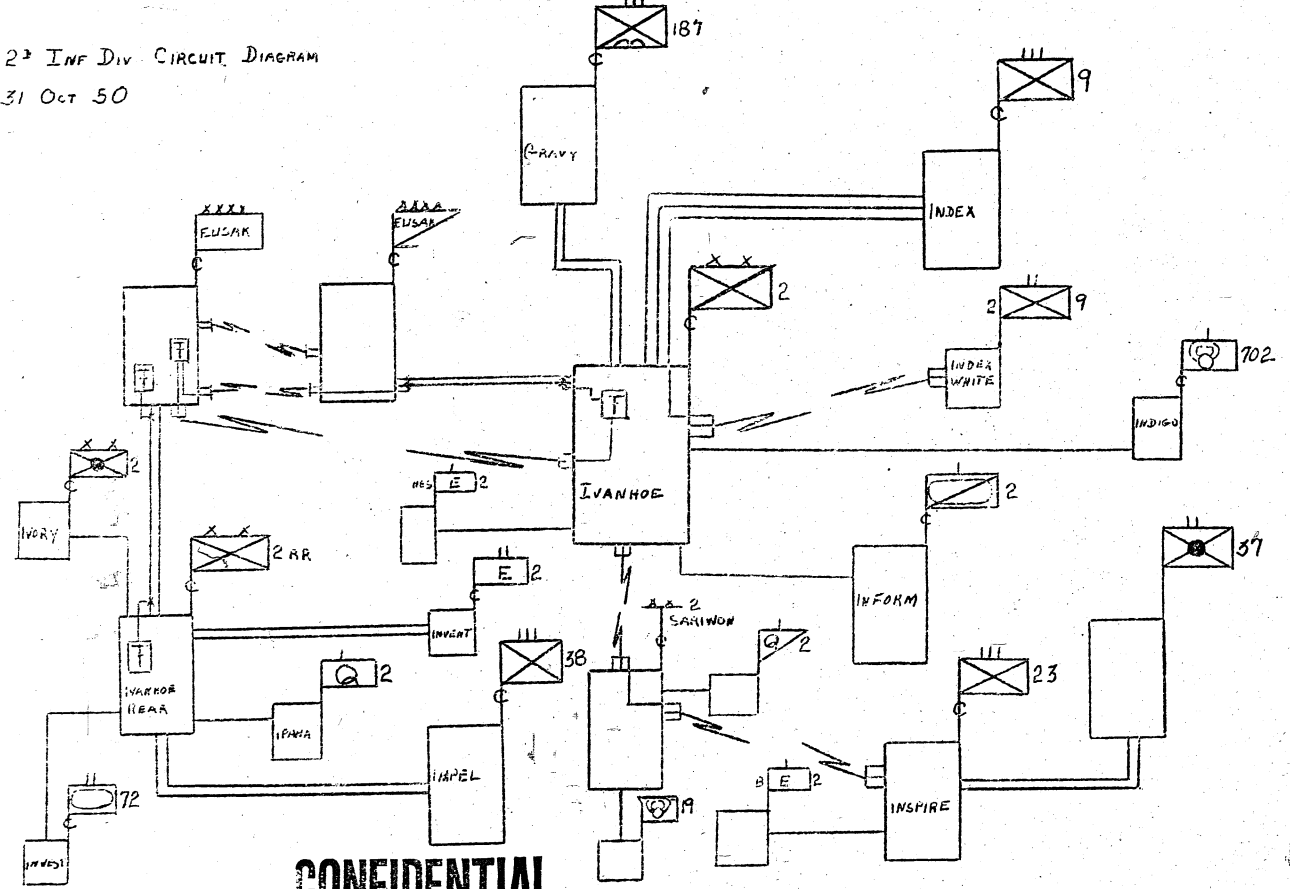

CONFIDENTIAL

CONFIDENTIAL

2³ INF DIV VHF CIRCUIT DIAGRAM

31 OCT 50

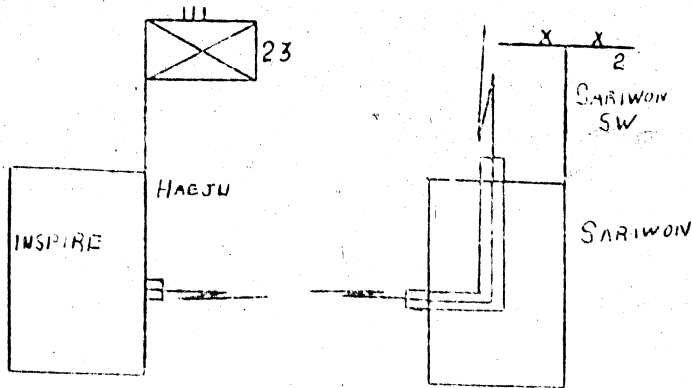
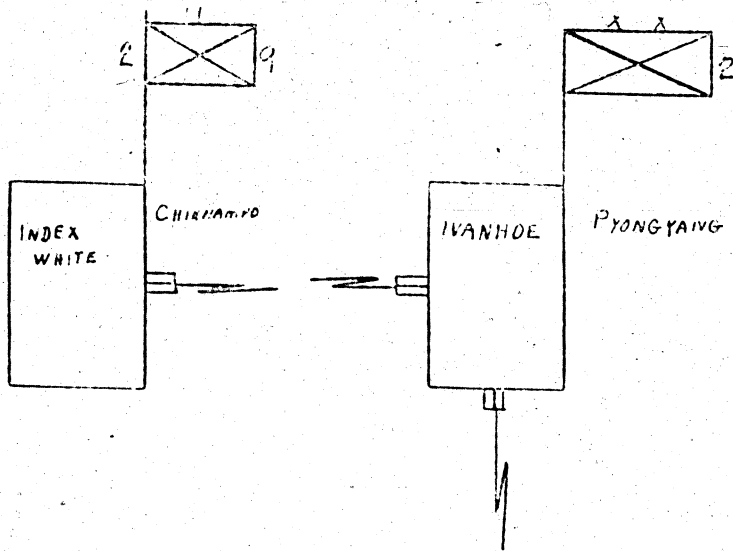

CONFIDENTIAL

CONFIDENTIAL

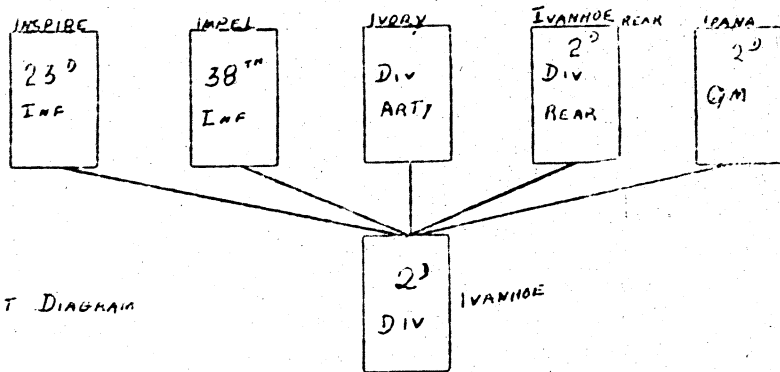
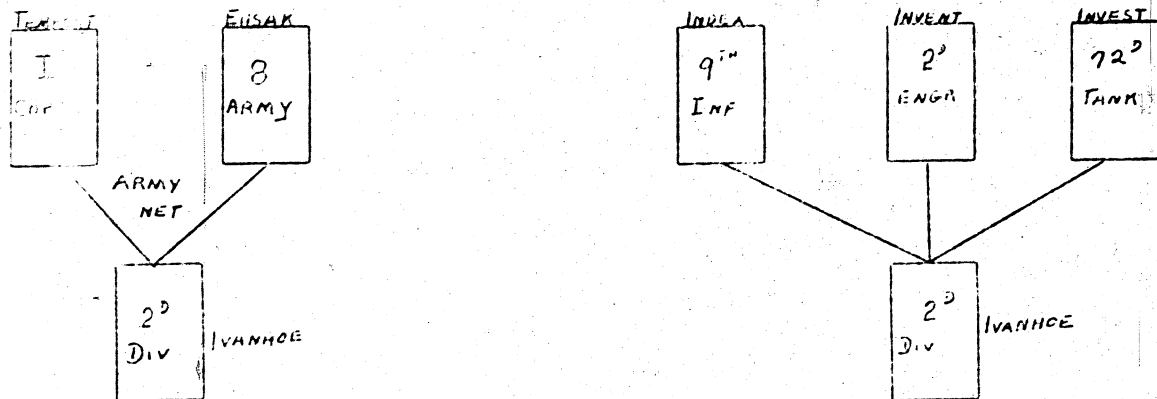

2nd INF DIV RADIO CIRCUIT DIAGRAM
31 JUL 50

CONFIDENTIAL

Surg Sect

HEADQUARTERS 2D INFANTRY DIVISION
Office of the Surgeon
APO 248

5 October 1950

HISTORY

Section I

DIVISION MEDICAL ACTIVITIES

On the 1st of September 1950, the casualty rate of the Division greatly increased due to the heavy offensive action of the enemy. Because of poor communication Col Dice, Commanding Officer of the 2d Medical Battalion, was called to stay at the Division Surgeon's Office for the first 3 days, in order that he might better keep abreast of the situation and employ his Battalion to a greater advantage.

One of the initial medical problems was the delivery of medical supplies to isolated units that were surrounded by the enemy. Col Sinsel, C-4, notified the Division Surgeon that arrangements were being made for air drops of food, water, paroline and ammunition to these troops. Immediately Col Carle directed the Division Medical Supply Officer to prepare packets of emergency type medical supplies to be included in the drops.

As the casualty rate increased, it was necessary to utilize trucks, 2 1/2 ton and 3/4 ton for evacuation; these proved to be very satisfactory as their capacity is much greater than the field ambulance.

At 0930 on the morning of 1 Sept, Col Carle contacted the Eighth Army Surgeon requesting helicopter evacuation. Two helicopters were placed at our disposal to be utilized as emergency type evacuation. They were based near the CP and dispatched by the Surgeon on call from the various clearing stations. The helicopters were not permitted to evacuate from Battalion aid stations or collecting stations due to their vulnerability to small arms fire. The type of patient evacuated was confined to chest, head and stomach wounds where evacuation by field ambulance would likely be fatal.

It became apparent during the first few days of the month that blankets and litters were very critical; this was due to the fact the property exchange with Army train evacuation was not functioning as these items were also critical in the Army installations. The Division Surgeon directed that a Warrant Officer from the Division Medical Supply be placed at Pusan with the mission of obtaining litters and blankets and shipping them to the Division. The adverse weather, especially during the period 1 - 10 Sept was partly to blame

for the shortage of blankets. However, when the weather did clear so blankets could be dried in the sun, the Division had an ample supply.

Medical Department Officer questionnaires were received on the 4th of Sept and distributed to all Medical Department Officers of the Division; these were completed and returned to the Army Surgeon on the 26 Sept 50.

24 MWS were utilized during the month by the 23rd Medical Company. A tour of all installations by the Division Surgeon with the view of determining the status of units and the possibility of utilizing MWS resulted in the following: that each medical company could utilize 36 MWS and the 2d Medical Battalion, 70. It was recommended, due to their limited training, that they be used primarily as litter bearers, under the supervision of a US soldier.

On the 17th of Sept, Col Carle received notification of his promotion to Colonel, per par 12, CG 172, DA, dtd 7 September 1950. On the 19th, we moved to the vicinity of UNKUNNUN. On the 21st of September we moved to the vicinity of TUK-21 and to UNKUNNUN on the 26th.

On 27 Sept, Col Barr, from the Theatre Surgeon's Office, called Col Carle regarding encephalitis, stating that the Division had 70 patients evacuated with a confirmed diagnosis, resulting in 22 fatalities. Further, that due to the tactical employment, shortage of serum and because it was so late in the season, it would be impractical to attempt to inoculate against this disease.

On 28 Sept, the Division moved to UNKUNNUN out of range for Army helicopter evacuation. Therefore, arrangements were made with Division C-53 Air whereby the one L-5 airplane within the Division would be reserved for evacuation of seriously wounded patients.

At the close of this period, 39 MWS, 30 MWS and 15 MWS CMM were on duty with the Division.

Losses of Medical Department commissioned personnel during the month were as follows: Major Charles E. Frick, MDC; Lt Earl E. Hinton, MDC; Lt Ralph E. Reed, DC.

Health of the Command was as follows:

	1 Sept		8 Sept		15 Sept		22 Sept		29 Sept	
	CASES	RATES	CASES	RATES	CASES	RATES	CASES	RATES	CASES	RATES
Common Respiratory Dis	5	15.0	3	10.8	61	200.7	20	71.3	31	103.0
Influenza					1	3.3	1	3.5		
Pneumonia, Primary, typical	2	6.0	1	3.5			1	3.5	1	3.3
Streptococcal Sore Throat			1	3.5						
Common Diarrhea	20	62.5	7	25.3	37	122.2	15	53.5	15	50.4
Dysentery Unclassified	16	48.2	4	13.8	3	9.9				
Dengue Fever	8	24.1	4	13.8	1	3.3				
Malaria, acquired out- side U. S.	45	135.5	51	184.9	24	78.6	2	7.1	1	3.3
Hepatitis, infectious			1	3.5						
Scabies			1	3.5						
Fever of Undetermined origin	55	165.7	41	148.6	62	204.5	59	210.6	42	141.3
Trench Foot	2	6.0	4	13.8						
Measles	1	3.0								
Mycotic Dermophytosis	5	15.0			2	6.5	2	7.1		
Syphilis					1	3.3				
Other Venereal					1	3.3			4	13.4
Mumps							1	3.5		

HEADQUARTERS 2D INFANTRY DIVISION
Office of the Surgeon
APO 248

5 November 1950

HISTORY

DIVISION MEDICAL ACTIVITIES

On the 1st of October, the Division CP moved to Chonju. Evacuation was to the 8063 Mobile Army Surgical Hospital located at Sachon, and to the 8055 Mobile Army Surgical Hospital at Taejon.

An air evacuation system was started on 5 Oct by C-47 aircraft from various K fields located throughout southern Korea. The 2d Division was unable to utilize this facility due to our location. Air evacuation continued to be by one (1) L-5 aircraft assigned to the Division Headquarter's Air Section.

On October 5 the 8055 Mobile Army Surgical Hospital and the 8063 Mobile Army Surgical Hospital moved north, leaving the Division without 3rd echelon service. As there was no communication with the Eighth Army Surgeon's Office, Capt Wiscarson flew to Taegu to inquire as to where the Division was to evacuate. He was informed that the 64th Field Hospital was to be opened in Taejon on the 6th of October and we were to evacuate all patients to them.

Seventy (70) wounded NK PW's were found in the Provisional Hospital at Chonju on 8 October. They were seen by a medical officer from the 3rd Clr Pltn and evacuated through medical channels.

The Division CP departed Chonju on 9 October and arrived near Suwon that evening. On 10 October we departed Suwon and moved to the vicinity of Seoul where the CP was located in the Middle School. Evacuation was to the 4th Field Hospital which was located in Ascom City.

On 11 October we received instructions from Eighth Army Surgeon's Office to place one (1) Dental Officer who had experience in oral surgery and one technician with equipment on TDY with the 8076 Mobile Army Surgical Hospital.

On 12 October Col Carle flew to Taejon for a conference with the Eighth Army Surgeon. Conference included future plans for the employment of the 8076 Mobile Army Surgical Hospital; it was decided that in the future the Mobile Army Surgical Hospital would locate near a Clr Pltn if the situation permitted rather than remain at a railhead.

On 12 October one (1) Army Ambulance Platoon reverted back to Army control. The 8076 Mobile Army Surgical Hospital closed at Suwon in support of the Division on 13 October.

On 15 October a conference was held with all unit surgeons, discussing the problems encountered since the Division arrived in Korea.

On 16 October we received instructions from G-2 to have one (1) Medical Officer and four (4) EM with an abbreviated aid station at the 2d Recon Area at 1000 hrs on the 17th, to support a special Task Force of four or five days duration. This unit was later identified as Task Force Indianhead. The detachment was made up from the Medical Company of the 38th Infantry Regiment.

On 17 October the 9th Regimental Combat Team was formed and placed under I Corps. One Ambulance Platoon and one Clearing Platoon (2d Med Bn) were detailed as a component of the RCT.

The 8076 Mobile Army Surgical Hospital, on 21st of October, moved from Suwon to Sinmak. Later the same day the Eighth Army Surgeon notified Col Carle that the 8076 Mobile Army Surgical Hospital would move on to Sariwon.

Col Grower (Theatre Consultant on Dermatology) arrived on the 22d of October to discuss the incidence of dermatitis within the Division. He was accompanied by Col McAllister, Executive for the Eighth Army Surgeon.

Col Carle departed on October 25th to visit Division Medical Units located in the Pyongyang-Sariwon areas. He returned on the 27th of October with the information that the 8076 Mobile Army Surgical Hospital was to move to Haeju.

The Division CP moved to Pyongyang on the 28th. The 29th of October we received instructions from the Eighth Army Surgeon to place two MC officers on a 30 day TDY with the 171st Evacuation Hospital, Pyongyang, for the purpose of providing dispensary type care for the PW enclosures. Col Carle inspected the PW enclosure in Pyongyang on the 31st of October and also visited the 171st Evacuation Hospital and the 9th Medical Company.

On 31 October at a G-3 meeting Col Carle was notified that the 9th Regimental Combat Team was alerted for movement north. Col Carle notified the 2d Med Battalion to alert one Clearing Platoon and One Ambulance Platoon to accompany the 9th RCT. Col Carle contacted the Surgeon of the 9th Infantry and informed him that he was relieved of his PWE and Civil Assistants responsibility. He then notified Major Lane, Surgeon of the 187th AB Regiment that his unit would provide medical service for the PWE's, and that he, Major Lane, would serve as an advisor to the Civil Assistant's Office in Pyongyang. G-4 requested on 31 October that

the Surgeon place one (1) MC or MSC at the Civil Assistant^{CE}s Office to conduct a physical inspection of candidates for the Pyongyang Police Force. Col Carle requested that the 2d Medical Battalion furnish one capable MSC because the movement of the 9th RCT and the FWE commitments utilized all available MC's in this area.

Casualties during the month were comparatively light as the Division was meeting very light resistance.

At the close of this period 38 MSC, 30 MC and 15 DC Officers were on duty with the Division.

Losses of Medical Department commissioned personnel during this month were as follows: Major Charles K. Rath, MC; Lt Richard W. Carrier, MSC.

Health of the Command was as follows:

	6 Oct		13 Oct		20 Oct		27 Oct	
	CASES	RATES	CASES	RATES	CASES	RATES	CASES	RATES
Battle Casualties	70	277.9	11	43.3	7	25.7	3	10.9
M/B Casualties	53	200.9	43	162.7	57	209.3	38	139.3
N.P.	11	42.4	12	47.2	16	58.7	11	40.3
Fever of Undetermined Origin	26	100.4	35	138.0	12	44.0	4	14.6
Upper Respiratory Dis	12	46.9	13	51.2	15	55.0		
Influenza	3	11.6	1	3.9	2	7.3		
Mumps	1	3.8					1	3.8
Pneumonia, secondary	1	3.8						
Common Diarrhea	5	19.2	8	31.5	14	51.4	10	38.1
Dysentery Unclassified	3	11.6			1	3.8	4	14.6
Malaria, acquired outside U. S.	4	16.1	5	19.4	1	3.8	1	3.8
Mycotic Dermophytosis	1	3.8	1	3.9	2	7.3	24	87.9
Pneumonia, primary			1	3.9	1	3.8		
Hepatitis, infectious			1	3.9				
Rheumatic Fever			1	3.9				
Scabies			2	7.8	1	3.8		
Gonorrhea			1	3.9				
Bacterial Food Poisoning					1	3.8		



Trans Sect

HEADQUARTERS 2D INF DIVISION
APO 248 C/O FM San Francisco California
Division Transportation Officer

HISTORICAL NARRATIVE REPORT

1 - 31 OCTOBER 1950

During October the Transportation Section continued to report to higher Headquarters the incoming rail shipments to Division railheads.

Two Truck companies from Eighth Army continued in support of Division. The supply line continued to be stretched to a distance of 165 miles from Division railheads.

During the month the railhead was changed from Miryang to Chinju to Nonsan to Suwon to Orydong. During the change of railhead from Miryang to Chinju three daily supply trains were not received. One LST docked 4 days late at Kunsan during this period and the cargo was split 75% for 2nd Division and balance for 25th Division.

The Transportation Section supervised the procurement of rail equipment to move LST Cargo from the Port of Kunsan to Division railhead at Nonsan. The procurement was not easily effected as there was no operating personnel for rail equipment nor lines of communications. The Korean rail personnel when available were very reluctant to operate at night. This necessitated armed personnel riding in the cab with the engineer at all times.

Due to the combined efforts of the Transportation Officer and G-4 one train was able to be loaded with 10 cars and dispatched to the Division railhead. Balance of cargo was trucked to railhead.

During this period the first Division troop movement by rail was attempted and succeeded after many delays.

The foot elements of the 9th RCT was moved by rail from Nonsan to Suwon. This type of move will not be considered in the future due to the troop harassment in that a move of 100 miles in box cars took 48 hours.

During this period the Transportation Officer in conjunction with G-3 and Provost Marshal established road priorities for movement of units and maintained convoy discipline.

Strict priorities and convoy discipline was necessitated by poor MSR's

The latter part of the month Division became Army Reserve. Immediately Army directed the 2nd Infantry Division to furnish 320 trucks from units of the Division for the support of I Corps engaged in offensive operations in Northern Korea.

This operation required 19 Officers, 640 Enlisted Men and 23 mechanics. A mess was established at both ends of the supporting supply run. The supply run varied in length from 210 miles to 300 miles.

During the latter part of the month the 2nd Division opened and operated the Port of Haeju and received 10 motor barges and one LST loaded with Class I and III.

The rail line was operated from Haeju to Sariwon by 3rd TERS under the supervision of the 2nd Division.

Approximately 1500 tons of supplies were received, sorted and shipped by personnel of 2nd Division thru the port of Haeju.

The Division G-4 Transportation Officer's scope of operations far exceeds what is normally a Division or even a Corps Transportation Officer.

The lack of Army to coordinate rail movements and their reluctance to move into forward areas when they have been secured to exploit the rail and port facilities that are available has been a detriment and has necessitated the Division using organic vehicles to haul supplies as much as 265 miles one way. This has necessitated setting up intermediate supply points for convoys.

The Division G-4 Transportation Officer continues to coordinate all movement of supplies by rail and road in and to the Division area.

G-5

HEADQUARTERS
2d Infantry Division
APO 248 c/o Postmaster
San Francisco California
Office of the Civil Assistance Officer

10 November 1950

SUBJECT: Activities Report

TO: The Adjutant General
Department of the Army
Attn: Chief, Historical Records Section
Departmental Records Branch
Washington 25, D. C.

1. On 13 October 1950, Colonel John G. Coughlin, O18898, Infantry, was assigned Civil Assistance Officer, 2d Infantry Division, pursuant to authority contained in Message No. 1367-EUSAK. Pursuant to the same authority, Civil Assistance Officers were designated in each of the Regimental Combat Teams, as follows:

Lt Col James F. Hill, 9th Infantry Regiment
Lt Col John W. Londahl, 23d Infantry Regiment
Lt Col Milton S. Norum, 38th Infantry Regiment

On that date, the Division CP was located at Yongdungpo, Korea.

2. On 20 October 1950, Major Donald E. Zeis and Captain John E. Byron were assigned and reported as Assistants to the Division Civil Assistance Officer.

3. Preparation was begun on a Civil Assistance Program to be followed within the Division. Information was also received from the Civil Assistance Officer-EUSA - that that headquarters would publish all proclamations and ordinances, except in cases of emergency. In addition to this information, Annex I, Administrative Order 26-A, Hq EUSAK, dated 9 October 1950, was received. This order outlined, generally, the duties and responsibilities of Civil Assistance Officers within the Eight Army area of responsibility.

10 November 1950

4. On 23 October 1950, the Civil Assistance Team of the 9th Infantry Regiment assumed civil assistance responsibility for the City of Pyongyang, former capital of North Korea. A mayor and bureau chiefs had already been appointed by the Civil Assistance Team, I Corps, and some of the normal civil activities of the city were being resumed. Continuing investigation of appointed officials was being made and other persons suitable for assuming governmental responsibility were being sought. In Kwanghae Province, the 23d Infantry Regiment Civil Assistance Team was established. Headquarters was located in Haeju, and a provincial governor and bureau chiefs were appointed. A mayor and bureau chiefs were also appointed in the City of Haeju. In both instances, investigations were being made as to the amount of food on hand; medical supplies available; hospital facilities and doctors present; and immediate future requirements. No immediate threat of food shortage was reported, nor was there any imminence of widespread suffering or disease. However, due to lack of electrical power, the water supply in Pyongyang was inadequate.

5. Information was received from the Commanding General, I Corps, that there was no Military Government in effect in Korea and that none was contemplated; military commanders were charged with placing the responsibility for public safety, welfare relief, medical care, general control, and other activities of the civilian community upon the local civil government. They were further charged with the responsibility of assisting these local governments to the greatest extent possible.

6. On 26 October 1950, general instructions for all civil assistance officers within the division were issued by the Division Civil Assistance Officer. A copy of this letter is submitted with this report. Also, the Civil Assistance Officer, EUSAK, advised this office that it had been reported that 3,000 bags of rice were needed in Haeju for a ten day period and that there was no rice in Seoul available for shipment. This office was instructed to investigate the report and to determine the urgency, the number of inhabitants needing food, and the likelihood of starvation, disease and unrest. The Civil Assistance Officer, 23 Infantry Regiment, stated that the report was erroneous and further stated that, although the investigation was being continued, there was no food shortage, nor was there any likelihood of starvation or suffering. Report of shortage had been made by unit previously occupying that area.

7. Alert orders that the Division CP would move from Yongdungpo to Pyongyang on 28 October 1950 were received, and Colonel Coughlin and Major Zeis departed for Pyongyang on 27 October 1950.

SUBJECT: Activities Report

10 ovember 1950

At 0500 hours, 28 October 1950, this office closed at Yongdungpo and opened at 1645 hours in Pyongyang.

8. On 29 October 1950, information was received from the Civil Assistance Officer, EUSAK, that a Civil Assistance Team from that headquarters would assume responsibility for the province of Pyongan Mando, but that the team from the 9th Infantry Regiment would continue to maintain its functions in the City of Pyongyang. Actually, the Army Team had arrived in Pyongyang on 28 October 1950. The Civil Assistance Officer, 9th Infantry Regiment, was designated Executive Officer for the Army Team. Under this new plan, activities were broadened and work with city and provincial officials continued.

9. On 31 October 1950, a War Survey Team arrived in Pyongyang to make an estimate of the war damages in North Korea. At the end of the period, Civil Assistance Officers were directed to report progress made in their areas and the results of any surveys that had been conducted.

FOR THE CIVIL ASSISTANCE OFFICER:

JOHN E. MORAN
Capt, Inf
Asst CA Off

JOURNAL

~~Gen~~ Section

G-5

From: 18 October 1950
 To : 23 October 1950
 Place: Yongdungpo, Korea

SECRET

Time		Ser No.	Time Dtd.	Incidents, messages, orders	Action Taken
In	Out				
			10-18	Colonel Coughlin reported for duty as Civ Assistance Officer for 2d Inf Div per authority contained in Msg No. 1367-EUSAK.	
			10-19	Colonel Coughlin visited Civil Assistance Officer, EUSAK, to discuss organization of Civil Assistance Teams.	
1650		Tel Msg	10-20	Major Zeis reported for duty as Asst Civil Assistance Officer. Colonel Coughlin conferred with Regt S-5's. Captain Byron reported for duty as Asst Civil Assistance Officer. C. Officer, 38th Inf, called to learn whether EUSAK would issue proclamations.	Ref to EUSAK
			10-21	Capt Byron visited EUSAK CA Officer who stated that he would issue proclamations, ordinances, etc., except in case of emergency. Received four copies of ANNEX I, Admn Order 26-A, EUSAK, dtd 9 Oct 50.	
		Tel Msg	10-22	Distribution made to CA Officers, 9th Inf, 23d Inf and 38th Inf Regts of Annex I, Admn O 26-A, EUSAK. Provost Mars al reports authority from EUSAK to take South Korean MP's north of the 38th parallel.	
0930	0930	5256	10-23	Msg from I Corps-Submit names of all C. Officers in Div. See Incl No. 1.	CA Offs notified & Div Staff Sections
	1156	1		Msg to I Corps giving names of CA Offs in Regts.	
	1300	2		Msg to 9th, 23d, 38th Inf Regts transmitting Msg No. 5256 from I Corps. See Incl No. 2.	
	1305	5300		Msg from I Corps re establishment of No Korean Govt in Pongrang area. See Incl No. 3	

JOURNAL

~~XXX~~ Section
G-5

From: 24 October 1950
To : 26 October 1950
Place: Yongdungpo, Korea

SECRET

Time		Ser No.	Time Dtd.	Incidents, messages, orders	Action Taken
In	Out				
			10-24	Col Coughlin visited Civil Assistance Officer-EUSAK- and returned with 9 copies of Annex I-Admn O 26-A. Distribution of one copy per Bn was made.	
0916		5517	10-25	Colo Coughlin departed for conference with CA Officers in Taeju and Pyongyang. CO 9th Inf: There is no Mil Govt in effect in Korea and none is contemplated. CA Officers have the responsibility of assisting local communities to establish their own Govt. CG, I Corps: Same as above. Col Coughlin returned from Pyongyang.	
0925		5520			
1015		4	10-26	Col Coughlin visited Civil Assistance Officer-EUSAK. Ivanhoe Advance: Jackson Six requests CA Officer, 2d Div, report Pyongyang City Hall for conference with Col Crondez. General Instructions for all CA Officers in 2d Div was published in Ltr, Civil Affairs, copy of which is enclosed. See Inel No. 4 CG, 2d Div: CA Officers, 9th and 187th advised to attend conference. EUSAK sending team Pyong yang for purpose coordinating CA activities between areas responsibility of I Corps and 2d Div.	
	1145	4			
2315		5727		EUSAK: Info received from I Corps that 3,000 bags rice required Haeju for 10 day period. No rice presently available Seoul for shipment. Request investigation of situation and report of urgency, number of inhabitants needing food, likelihood of starvation disease and unrest.	CA Off 23d Inf directed to investigate and report
2315		5728		EUSAK: Fragmentary Opns Order assigns Pyongyang to 2d Inf Div, whereas majority of Pyongan Namdo is asgd to I Corps. Desire I Corps maintain able Liaison Off with 2d Inf Div CA Agency Pyongyang for coordination	

JOURNAL

Section

From: 27 October 1950
 To : 1 November 1950
 Place: Yongdungpo, Korea
 Pyongyang, Korea

Time		Ser No.	Time Dtd.	Incidents, messages, orders	Action Taken
In	Out				
1500		17	10-27	Col Coughlin and Major Zeis departed for Pyongyang. CO 23d: Report on rice situation in Haeju Province erroneous. No present shortage of food or fuel. Full report will be sent soonest. Erroneous report was sent by unit occupying this area previous to us.	
			10-28	Div CP departed Yongdungpo 0500 hrs and arrived Pyongyang 1645 hrs	
	1500		7 97	10-29	CG, 2d Div: Report progress to date and results of any surveys made in your area re civil affairs. EUSAK: Provincial Civil Assistance Team for Pyongan Nampo will depart Seoul by vehicle 28 Oct 50. Team consists of four US officers, two UN civilians, six EM, two ROKA officers plus three ROKA EM. Team attached to 2d Ind Div. Attachment will automatically terminate should 2d Inf Div be relieved of responsibility for Civ Affairs in Pyongyang.
0815		13	10-30	Col Coughlin visited 187th RCT CA Officer. Major Zeis departed for Haeju to secure report on CA activities.	
			10-31	EUSAK: Desire that terms Quote Civil Affairs Unquote and Quote Civil Affairs Officers Quote be dropped from usage. Report of current activities submitted EUSAK. Lt Col Sundahl, Engr, EUSAK, Mr Knox, ECA, and Mr Lee, Dir of Pub Utilities, ROK, arrived to make survey of war damages in North Korea.	Msg sent to all CA Offs 2d Div Referred to Col Munske, CA Officer, Pyongan Nampo

CONFIDENTIAL

HEADQUARTERS
2d Infantry Division
APO 248, c/o Postmaster
San Francisco California

G-5 014.13

26 October 1950

SUBJECT: Civil Affairs

TO: Commanding General, 2d Division Artillery
Commanding Officers, Regiments and Battalions
Commanding Officers, Separate Battalions and Companies assigned or
attached to 2d Infantry Division

1. General.

a. Military operations conducted by the United Nations Forces in Korea north of the 38th parallel are primarily for the purpose of completing the destruction of North Korean Forces. During such operations, local North Korean civil authorities will be held responsible for the maintenance of law and order under the supervision of such UN forces as are in the area pending the determination of the timing and method of uniting the territory north and south of the 38th parallel into one republic. Civil activities therefore, will be conducted through local civil authorities to the maximum extent which military necessity permits. In cases where local civil authorities have fled the area or are considered to be undesirable or to be incompetent to effectuate necessary civil activities, the local commander will notify the Division Civil Affairs Officer who will designate individuals in the area to conduct essential civil activities.

b. The Division Commander is responsible for the general welfare of the civilian population within the division zone through local civilian governments. Direct military Government will not be established. Local area commanders will place the responsibility for public safety, welfare, relief, medical care, and the implementation of other provisions of this directive upon the local civil Governments to the maximum possible extent.

2. Responsibility.

a. UN Military Forces in Korea.

The control of the inhabitants in areas of Korea north of the 38th parallel is the responsibility of CG, Division Command within its area in accordance with policies herein set forth as modified or amplified from time to time by higher headquarters. This control of local populace will be exercised to:

- (1) Prevent interference by local inhabitants with military operations.

CONFIDENTIAL

CONFIDENTIAL 26 October 1950

- (2) Insure the security of the military forces.
- (3) Facilitate the safety and well-being of local inhabitants.
- (4) Provide humanitarian needs to prevent disease and unrest.
- (5) Facilitate the early return of the populace to peaceful production.
- (6) Safeguard natural resources and assets in the interests of the subsequent civil administration.
- (7) Create conditions favorable to early unification of the area into one republic.

Commanders of all echelons will take all necessary measures to prevent reprisals against the forces, officials and populace of Korea north of the 38th parallel except such as may be in accordance with international law.

3. Civilian Supply

- a. Local commanders will make immediate report in cases where the need for direct relief supplies to prevent disease and unrest among the civilian population north of the 38th parallel exists.
- b. Report will show name and location of the place, population, supplies presently available, normal source of supply and supplies required.
- c. G-4 will check the request with the local authorities responsible for the administration of the areas in the Division Zone and ascertain if supplies are available in other localities within the Division Zone to meet the need.
- d. When the required supplies are not available from local sources within the Division Area of responsibility, the request will be forwarded to the next higher headquarters.

4. Public Health.

- a. The following action will be taken to prevent disease and unrest among the civilian population:
 - (1) The establishment or reestablishment of essential civilian health control measures to prevent the spread of communicable diseases likely to interfere with the success of the United Nations mission.
 - (2) The seizure of military supplies of the North Korean Army which can be used for direct relief to the civilian population such as food, fuel, clothing, medical and sanitary supplies and equipment. Unit making seizure will make immediate report to this headquarters stating location type, and approximate amounts of such supplies.

2
CONFIDENTIAL

CONFIDENTIAL

26 October 1950

G-5 014.13

SUBJECT: Civil Affairs

- (3) Distribution of food, shelter, fuel, clothing, medical and sanitary supplies essential to meet the minimum standards of humanitarian needs. Supplies captured in the Division area will be distributed under military supervision by local civilian officials so as to best meet the overall requirement.
- (4) Direct relief assistance to refugees and the indigenous population including personnel residing in welfare institutions.
- (5) The re-opening or continuance in operation of civilian hospitals, sanitoria, leprosaria and clinics for the use of the civilian population as rapidly as conditions permit or require.
- (6) Public sanitation control measures including restoration and protection of all public water supplies, sewage systems, and other waste disposal means.
- (7) Control of narcotics. Prohibition of the growth, manufacture and export of narcotics. The seizure and recording of all stocks of heroin, raw opium, and semi-processed narcotics. Seized stocks will be secured and reported to Division Surgeon who will designate a qualified officer to inspect and recommend disposition.

b. The controls and operation of activities enumerated in paragraph 4a above will be accomplished by local civil authorities to the maximum extent practicable at the direction and under the supervision of the military forces in the area.

5. Public Safety.

a. Law Enforcement. Local civil authorities will be held responsible for the enforcement of law and order among the civilian population, providing for the security of persons and property and enforcement of all proclamations and ordinances promulgated by military commanders for the control of the civilian population and the security of the military forces. Civil police utilized by civil authorities to enforce law and order may be permitted, on recommendation of the unit commander, to retain pistols and other police type weapons and ammunition therefor, except U.S. Government weapons and ammunition, in such quantities as prescribed. Each police station chief will maintain a register of arms so permitted.

b. Jails and Prisons.

- (1) Local civil authorities will be held responsible for the proper administration of jails and civil prisons. Unit commanders will insure that prisoners incarcerated in local jails and prisons, particularly political prisoners, are not mistreated.

CONFIDENTIAL

CONFIDENTIAL

25 October 1950

- (2) Prisoners found in jails and prisons will, if the situation permits, be screened by military personnel. After screening, offenders against North Korean criminal and civil codes will continue to be held in confinement to serve out their sentence. Prisoners convicted or awaiting trial on charges involving only offenses of political nature as opposed to offenses generally recognized as crimes by the laws of civilized nations will, after screening, be released if consistent with military objectives. This screening will be performed by Division CIC personnel as available.
- (3) North Koreans sentenced by occupation courts for offenses against UN Forces will normally be confined in existing North Korean jails or prisons.

c. Fire Department. Local civil officials will be directed to establish or reestablish adequate fire prevention and fire fighting organizations in their respective communities.

d. The Retention of Local Civil Authorities. Unit Commanders, by whatever means may be expeditious, will instruct local civil authorities, including police, prison officials, and fire fighting personnel, to remain on their assigned duties and perform essential civil functions unless and until relieved by, or on the instruction of, the appropriate military commander. Where local civil authorities are not available and special assistance is required in instructing selected personnel, request will be made to Division Military Affairs Officer.

e. Control of Liquor and Narcotics.

Local civilian personnel will not be permitted to sell, barter, or otherwise provide liquor or narcotics to United Nations Forces.

f. Control of Blackmarketing and Prostitution.

The control of blackmarket activities in United Nations Forces goods and the control of prostitution and wanderers dealing with United Nations Forces personnel will be the responsibility of each unit or area commander.

g. All weapons in hands of North Korean civilians will be collected. Weapons will be interpreted to include swords, fire arms, and explosives. Weapons collecting points will be established in each community. Civilians will be ordered to turn in all weapons, including ammunition in their possession to the local collecting point. All privately owned weapons turned in by the local civilian population will be marked or securely tagged to show the owner and address of the owner, the collecting point, and date of delivery. Local civilian authorities will be required to assist in the effective collection of all weapons. Privately owned weapons will be held in storage, separate from captured enemy arms, for eventual disposition in accordance with paragraph 336, FM 27-10, Rules of Land Warfare. Evacuation will be through normal military channels.

4 **CONFIDENTIAL**

26 October 1950

6. Legal Jurisdiction, Arrest and Detention, and Occupation Courts.a. Jurisdiction over Persons and Offenses.

- (1) No criminal or civil jurisdiction of any kind will be exercised by North Korean courts with respect to nationals of members of the United Nations or with respect to nationals of the Republic of Korea. Criminal jurisdiction over such persons will be exercised by Military Courts of the armed forces of the member nations and of the Republic of Korea in North Korea pursuant to the laws of the particular nation of which the forces are a part and subject to such agreements pertaining to the exercise of jurisdiction as are, or may be entered into, between the nations concerned.
- (2) The courts of North Korea will be permitted to exercise jurisdiction, civil and criminal, over all classes of persons other than those mentioned in (1) above, except that they will not be permitted to exercise jurisdiction over the following classes of offenses when committed against the person or property of any of the armed forces or of any national of any member of the United Nations or of the Republic of Korea, or of any person attached to or accompanying such forces:
 - (a) Killings and assaults.
 - (b) Burglaries, housebreakings and trespasses.
 - (c) Thefts, misappropriation, or unauthorized dealings in or possession of property.
 - (d) Acts injurious to the occupation.
 - (e) Acting for or supporting any organization dissolved or declared illegal by the Commander-in-Chief, United Nations Command, or by his subordinate commanding in the area.
 - (f) Interfering with or hindering the discovery or arrest of any person sought, or assisting in or furthering the escape of any person from detention or pursuit by the occupying forces.
 - (g) Interfering with, refusing information required by, making any false or misleading statement, orally or in writing to, or defrauding in any manner, any member of the occupying forces in a matter of official concern.
 - (h) Uttering or publishing any statement in derogation of the occupying forces or, in a matter of official concern, of any member of such forces, or of persons attached to or accompanying the same, or.

CONFIDENTIAL

26 October 1950

- (1) Conspiring to commit, aiding or abetting any of the above offenses.

b. Arrest and Detention. No national of any member of the United Nations or of the Republic of Korea shall be subject to arrest or detention by any North Korean authority.

c. Occupation Courts.

- (1) The Commanding General, 2d Infantry Division, will appoint from time to time, such provost courts as may be required to dispose of cases arising within the Division areas of responsibility.
- (2) Jurisdiction and Composition. Such occupation courts shall have criminal jurisdiction over all persons within and over all crimes committed in North Korea, but shall not exercise jurisdiction over the following classes of persons:
 - (a) Any member of the occupying forces or any person attached to or accompanying such forces, unless such persons are not triable by military courts of their own nation.
 - (b) Persons entitled to diplomatic immunity.
 - (c) Prisoners of War.
- (3) Sentence imposed by occupation court may include death, imprisonment for life or for a term of years, fines, confiscation of property, locking or otherwise closing premises, suspension or revocation of privileges, deportation of noncitizens, and expulsion of persons from designated areas.
- (4) The Commanding General, 2d Infantry Division, is authorized to appoint general and special provost courts. General provost courts may impose any lawful sentence except death, imprisonment in excess of ten years, or fine in excess of \$10,000, and special provost courts may impose any lawful sentence except death, imprisonment in excess of one year, or a fine in excess of \$1,000.

7. Retention and Abrogation of Laws.

Laws, decrees and regulations which establish discrimination on grounds of race, nationality, or political opinion will be abrogated; those which conflict with procedures, objectives, and policies of the military operation will be repealed, suspended, or amended as required. With the foregoing exceptions, local laws will continue in force.

CONFIDENTIAL

CONFIDENTIAL

26 October 1950

8. Proclamations and Ordinances.

* Such proclamations and ordinances as may be necessary to accomplish the mission of military operation will be published in English and Korean. The inhabitants of the territory shall be informed by such proclamations and ordinances of what they may and what they may not do. Offenses will be clearly and simply stated, and the population will be warned of the penalties which may be imposed for failure to obey these publications. So far as possible, specific, rather than general, prohibitions will be announced, and specific publication will be given to offenses mentioned in paragraph 6a (2), together with the announcement that commission of such offenses, and any others which may be prescribed will result in death or such other punishment as an occupation court may direct. Proclamations and ordinances are being prepared by higher headquarters and will be distributed as received.

9. Persons and Property.

In all other matters not specifically provided for herein, the relations of the military forces to the persons and property, public and private, of the territory and its inhabitants will be governed by the Hague Convention of 1907. Appropriate measures will be taken to insure protection of religion and morality, family honor and rights and of property of institutions dedicated to religion, charity, education, and arts and sciences, and to historic monuments and works of art.

10. Procurement from Local Sources.

a. Requisitions in kind and services, including buildings for offices and quarters, may be demanded from municipalities or inhabitants for the needs of occupying forces, excluding private homes which are occupied. Commanders will exercise requisition authority so as to insure against causing starvation, disease, or acute physical distress among the inhabitants.

b. Requisitions will be processed through local authorities if possible, but in any case may be made by direct demand on inhabitants having control of the goods or services desired. Major units will designate officers to exercise requisitioning authority and report names of same to this headquarters (Attn: G-5). The requisitioning authority will insure that appropriate records are maintained and receipts issued so that private owners can be compensated later either by North Korean authorities or by occupying forces from funds requisitioned from North Korean authorities. This requisition will have attached an inventory of all property in the building. Copies in duplicate of all requisitions will be forwarded this headquarters (Attn: G-5). Forms for this purpose will be provided by separate distribution.

c. Coercive measures, if required, will be limited to the amount and kind reasonably necessary to secure the articles requisitioned.

d. Money contributions will not be levied except pursuant to order of the Commander-in-Chief, United Nations Command. No measures will be taken to institute additional or modify existing control of commodity prices except on the authority of the Commander-in-Chief, United Nations Command.

7
CONFIDENTIAL

e. Payment will not be made for Government owned property or facilities taken or used by the United Nations Forces.

11. Finance.

a. General.

The financial and economic objectives of Military Operations in Korea North of the 38th Parallel are primarily to provide for the needs of the Military Forces, and secondarily to prevent the dissipation of natural resources and assets, the dissipation of economy, and the transfer or export of assets which would be prejudicial to the best interests of the subsequent Civil Administration.

b. Controls.

Commanders, with area responsibility, will, pending receipt of further instructions:

- (1) Close all banks and prohibit all banking transactions except such as may be necessary to provide for military operations, and to provide essential maintenance and security of banking property and records.
- (2) Prohibit transfers or other dealings in private or public securities, real estate, or other property of substantial value.
- (3) Prohibit all other property transactions except such as are necessary to meet the ordinary requirements of daily life.
- (4) Close stock exchanges, insurance companies, postal savings accounts on deposit and insurance, loan associations, guild accounts and similar financial institutions.
- (5) Impound or block all gold, silver, platinum, foreign exchange and valuable papers and require from North Korean authorities such reports as deemed necessary to obtain disclosure of all such assets.
- (6) Prevent the collection of contributions of any kind for purposes inimical to the objectives of the military operation.
- (7) Declare a general moratorium.

c. Currency

- (1) North Korean currency, which is now the legal tender in Korea North of the 38th parallel, will be maintained as the only legal tender. No action will be taken to invalidate or prohibit the circulation of North Korean legal tender except as provided in this directive.

CONFIDENTIAL

20 October 1950

(2) A Division Funding Officer will be designated who will:

- (a) Secure from North Koreans authorities Korean legal tender notes free of cost and in amounts sufficient to meet all military requirements, including procurement which cannot be met free of cost by requisitions, in kind and services, upon local authorities. Services and supplies will be procured by requisitions insofar as practical.
- (b) Prevent exchange or conversion of North Korean currency, and circulation of Bank of Korea currency in North Korea, pending establishment of an exchange rate.

d. Accounts and Records:

- (1) The Division Funding Officer will establish and maintain detailed accounts and records to reflect the financial operations of Military activities, and to provide the Commander-in-Chief, United Nations Command with such information as he may require, including information in connection with the use of indigenous currency by Military Forces, occupation costs, and other expenditures arising out of operations or activities involving participation of occupation forces.
- (2) Cost data incident to requisition upon North Korean authorities for quarters, services and supplies will be compiled in report form.
- (3) Accounts will be opened insofar as practical on the basis prescribed in TM 14-704 (Accounting for Receipts and Disbursement of Public Funds). And TM 14-505 (Agent Finance Officers). Columnar sheets may be utilized.
- (4) Substantiating documents: Requisitions for funds, indigenous pay rolls, procurement vouchers with receipts, requisitions for services and supplies with cost data, and all time sheets; will be additional data which may be of value in settlement of reparations and United Nations Accounts will be filed in report form.
- (5) Agents of the Division Funding Officer will render returns as frequently as the situation demands, but not later than the 20th of each month.
- (6) The Division Finance Officer will forward to the Funding Officer a report of personnel costs based upon credits rather than actual disbursement made.

e. Agent Funding Officers:

Area commanders will appoint Agent Funding Officers who will, under the supervision of the Division Funding Officer, expedite the above directives in the commander's area of responsibility.

9 **CONFIDENTIAL**

26 October 1950

12. Economic.

a. North Korean authorities will be expected to carry out programs of working activity that will enable them out of their own resources and labor to accomplish the following:

- (1) Avoid acute economic distress.
- (2) Assure just and impartial distribution of available supplies.
- (3) Meet the demands for the needs of the military forces.

b. Unit Commanders will:

- (1) Require protection from destruction and the maintenance of all plants, equipment, patents, books, records, natural resources, and all other significant property that plays an important part in the North Korean economy.
- (2) Prevent or prohibit strikes or other work stoppages when it is considered that they would interfere with military operations, directly endanger the security of the military forces, or seriously endanger the public interest.

13. Political Affairs.

a. The general posture of UN Forces should be one of liberation rather than retaliation. The UN Forces should attempt to exert a stabilizing influence during the transition period. They should endeavor to conduct themselves in such a way as to emphasize the nonaggressive and temporary nature of UN occupation in any part of Korea. Every effort should be made to dispel the inevitable bitterness and resentment of the war-victimized Korean people.

b. The importance of instructing all troops in the general posture stated in paragraph a above cannot be over emphasized. The fair and honest execution of the provisions of this memorandum will shorten the length of our stay and materially assist in the recovery of Korea.

c. All Commanders are enjoined to insure that the maximum dissemination and understanding by our own personnel is achieved.

CONFIDENTIAL

G-5 014.13
SUBJECT: Civil Affairs

CONFIDENTIAL

26 October 1950

14. Communications.

Unit Commanders are authorized to take such measures as are deemed necessary to insure that the press or other media or communications, including telephone, telegraph, and radio, in their respective areas are not used to disseminate information inimical to the military forces, the Republic of Korea, or the objectives of the United Nations. No objection is perceived to the normal operation of such media in the dissemination of such information as is essential to the security, control and well-being of the local populace or the military forces.

BY COMMAND OF MAJOR GENERAL KEISER:

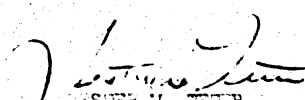
LESTER M. TETER
Colonel, GSC
Adjutant General

DISTRIBUTION:

"2"

1 Incl:
Annex 1

CONFIDENTIAL

CONFIDENTIAL

KOREAN GOVERNMENT ORGANIZATION

NATIONAL GOVERNMENT

DO (Province)

- a. A DO is composed of 5-13 GUN.
- b. The TO JI SA (Governor) is the official in charge, appointed by the National Government.

GUN (County)

- a. A GUN is composed of 10-15 MY ON.
- b. The KUN SOO (Gun Chief) is the official in charge, appointed by the TO JI SA (Governor).

MY ON (Township) and EUP (Town)

- a. A MY ON, or an EUP, is composed of 7-12 KU.
- b. The MY ON JANG (Myon Chief) and the EUP JANG (Eup Chief) are the officials in charge, appointed by the GUN SOO.

KU

- a. A KU is composed of 10-12 PAN.
- b. The KU JANG (Ku Chief) is the official in charge, elected by the Pan Chiefs from their membership.

PAN

- a. A PAN is composed of 15-20 householders.
- b. The PAN JANG (Pan Chief) is the official in charge, elected by the householders from their membership.

SI (City)

- a. The SI JANG (Mayor) is the official in charge, appointed by the TO JI SA (Governor).

DONG (Ward)

- a. A DONG is composed of 10-15 TONGS.
- b. The DONG WHE JANG (Dong-Chief) is the official in charge, elected by the (Tong Chiefs) from their membership.

TONG (precinct)

- a. A TONG is composed of 10-15 PANS.
- b. The TONG JANG (Tong Chief) is the official in charge, elected by the Pan Chiefs from their membership.

PAN

- a. A PAN is composed of 15-20 householders.
- b. The PAN JANG (Pan Chief) is the official in charge, elected by the householder from their membership.

Incl 1 to Annex 1 Civil Affairs

CONFIDENTIAL

CONFIDENTIAL

HQ 2D INF DIV
APO 248
26 October 1950

1. The responsibility for implementing the policies and directives stated in Civil Affairs letters and Memos rest with every area commander and with the personnel now assigned to his organization. Civil Affairs teams with special training may be available at a later date, but the implementation cannot await such teams or specialists.
2. Proclamations and Ordinances may be published by EUSAK from time to time. Only one has been published to date, copies of which have been requested. Others are in process.
3. The lack of currency and the pay of indigenous labor presents an immediate problem. Payment in kind or by the local community will have to be arranged pending further instructions.
4. The absence of qualified local administrative personnel only adds to the problem. The following chart outlines the Governmental organization believed to have previously existed and may be helpful in designating local officials.

CONFIDENTIAL

AG Sect

HEADQUARTERS
2nd Infantry Division
APO 248, c/o Postmaster
San Francisco California

HISTORICAL REPORT

Adjutant General's Section

September 1950

1. Summary of Activities

During the month of September 1950, this section was stationed at Miryang, Korea. Activities were routine in nature.

2. Statistical Data

Number of newly assigned EM processed and assigned by the Classification Section:

U S Personnel	530
ROK Personnel	3788
Returned to duty from hospital	1123

Number of newly assigned officers processed by the Officers Section:

U S Personnel	20
ROK Personnel	71
Battlefield Commissions	23
Returned to duty from hospital	18
Recalled to active duty	23

Casualties processed by the Battle Casualty Section through 30 September 1950:

Battle Casualties	4953
Non-Battle Casualties	159
Total	5112

ROK Battle Casualties	307
ROK Non-Battle Casualties	0
Total	307

Present attachments to the Division:

2d CIC Detachment
2d Plat, 565th QM GR Co (Attached 2d QM Co 12 Sept 50)
528 MI Service Platoon was relieved from attachment and attached I Corps 16 Sept 50.

3. Peculiar Problems

a. The biggest problem encountered during this period was transportation. It became increasingly difficult as the front lines moved farther forward to deliver replacements and mail to the units. During this period, the Division began receiving ROK Army personnel for assignment to combat units in increments of 500 every 5 days. 15 to 20 2½ ton trucks were needed to transport this personnel. Vehicles assigned to the Rear Echelon were being fully utilized in hauling mail and supplies. However, by utilizing Rear Echelon vehicles, ration trains and loan of vehicles from other units, personnel were carried forward with the minimum of delay.

b. As the units moved forward it became increasingly evident that mail service direct to units from the rear CP was impracticable. As a result, a system was devised whereby a portion of the postal section was established at the Class I Advanced Ration Point and moved with that ration point forward. Mail as received was brought into personnel sections of the rear CP where casualty and other mail was extracted, re-bundled and immediately forwarded by special truck to the Advanced APO. Thus units coming in for their rations could pick up the mail at the same time. In addition, the money order writing teams were stationed at the Advanced APO to service troops in that locality.

c. Due to the units being engaged in active combat, very few of them desired and received pay. Therefore, the money order business dropped off considerably. To those that needed this service, one of the procedures adopted was to have the agent officers paying the troops take up money order blanks for the men to fill out and when they brought the payrolls back to the Finance Office they were able to purchase desired money orders for the entire unit. By this method, the Division was more fully served, although at times during the month money order writing teams were dispatched on call to the major units.

4. Significant Lessons Learned

During this period of the greatest combat activity, personnel administration came to a virtual standstill. Units would be out of touch except for the tactical radio net for days at a time and the distances, while not great in miles, were great enough in point of time travel to preclude any rapid communications. The necessity of housing large numbers of replacements made increasingly apparent the total inadequacy of equipment and supplies as provided by the T/O & E. A case in point is the tentage shortage. This section is authorized one small wall and one CP tent for office and sleeping space for an authorized strength of 56 individuals. As a consequence, it was necessary to obtain without authority, water cans, electric generators, tentage, stoves, extra cooking units, clothing and personal equipment.

5. Discussion

None.

6a. Officer Personnel Assigned during Period

Col Lester W. Teter, 051512, AGC, Adjutant General
(Promoted to Colonel 7 Sept 50)

Capt Edwin C. McLaughlin, 044423, AGC, Asst Adj Gen
Capt John F. Regan, 060859, AGC, Awards & Decorations
Capt John F. Burns, 01012433, AGC, Asst Adj Gen
1st Lt Robert W. Funderburk, 02036175, AGC, Postal O
1st Lt James J. Maloney, 02025638, AGC, Officer Pers Sec
WOJG William H. Martin, RW 2141624, USA, Chief Clerk
WOJG Edwin L. McGrath, W903515, USA, Class & Enl Pers Sec
WOJG Raymond E. Wenzler, W904003, USA, Misc Sec

b. Officer Losses during Period

Maj William H. Hill	Evacuated to 8076 MASH, 12 Sept 50
2d Lt Harold R. Murdock	Reassigned to Office of the Chief of Staff, 22 Sept 50.

John F. Burns

HEADQUARTERS
2d Infantry Division
APO 248 c/o Postmaster
San Francisco California

HISTORICAL REPORT

Adjutant General's Section

October 1950

1. Summary of activities

On 2 October 1950 the Adjutant General's Section started to move from Miryang to Chinju, Korea a distance of 102 miles. This move was finally completed on 4 October 1950 by train and truck. Plans were immediately formulated to move on to Chonju a further distance of 115 miles without setting up operations. Move was finally completed on 6 October 1950 with the arrival of the last section. On the 14th of October 1950 the section again moved 143 miles to YongdongPo on the south bank of the Han River. Except for the loss of operating time from 1 - 6 October 1950, activities were generally routine.

2. Statistical Data:

a. (1) Strength at start of reporting period. 6 Officers, 3 WO's, 49 EM.

(2) Strength at end of reporting period. 6 Officers, 2 WO's, 51 EM.

b. Number of newly assigned EM processed by the Classification Section:

U S Personnel	523
ROKA Personnel	83
Returned to duty from hospital	983

c. Number of newly assigned officers processed by the Officers' Section:

U S Personnel	72
ROKA Personnel	0
Battlefield Commissions	55
Recalled to Active Duty	15
Returned to duty from hospital	22

d. Casualties processed by the Battle Casualty Section:

Battle Casualties	435
Non Battle Casualties	9
Total	444

ROKA Casualties	235
ROKA Non Battle Casualties	<u>3</u>
Total	238

e. Decorations issued during period 1 September 1950 thru 31 October 1950:

Silver Star	100
Distinguished-Flying Cross	56
Soldier's Medal	1
Bronze Star Medal	307
Air Medal	304
Army Commendation Ribbon	<u>1</u>
Total	769

f. APO operations during the period 21 August 1950 thru 31 October 1950:

Bags of mail received	5,220
Bags of mail dispatched	1,250
Money Orders written	14,933
Value of Money Orders written	\$1,091,479.43
Pieces of registered mail received	2,152
Pieces of insured mail received	4,000

g. Present attachments to the Division:

2d CIC Detachment
 2d Plat, 565th QM GR Co was relieved from attachment and reverted to parent unit 3 October 1950.

3. Peculiar Problems:

A continuing problem during this period is lack of integral transportation to effect the move of a Division Headquarters (Rear), a responsibility of the Adjutant General's section during combat. Moving by rail through war devastated country has proved impractical. The number of vehicles assigned to the Headquarters is insufficient to move approximately 60 officers and 500 enlisted men and impedimenta. As an example, the move from Miryang to Chinju, a distance of approximately 102 miles, took three days by rail and shuttling of vehicles available, while the move from Chonju to YongdongPo, a distance of 143 miles was completed in one day by utilizing trucks made available by other divisional units and the 540th Truck Company.

4. Significant Lessons Learned:

None

5. Discussion:

Due to units of the Division being in a static army reserve during the latter half of the month, much work was accomplished. Awards began to be a major problem.

6. a. Officer Personnel Assigned during Period:

Colonel Lester W Teter, 051512, AGC, Adjutant General
Captain E C McLaughlin, 044423, AGC, Asst Adj Gen
Captain John F Regan, 060859, AGC, Awards & Decorations
Captain John F Burns, 01012433, AGC, Asst Adj Gen
Captain Robert W Funderburk, 02036175, AGC, Postal O
(Promoted to Captain 17 October 1950)
Captain James J Maloney, 02025638, AGC, Officer Pers Sec
(Promoted to Captain 14 October 1950)
WOJG William H Martin, RW 2141624, USA, Chief Clerk
WOJG Edwin L McGrath, W 903515, USA, Class & Enl Pers Sec

b. Officer Losses during Period:

WOJG Raymond E. Wenzler, W 904003, USA. Transferred to 2d Medical Battalion, 17 October 1950.

LESTER W TETER
Colonel AGC
Adjutant General

SECRET

IG Sect

HEADQUARTERS
2d Infantry Division
Office of the Inspector General
APO 248 c/o Postmaster
San Francisco, California

SECRET

9 October 1950

SUBJECT: Historical Report .

TO: G-2 Section
Hq 2d Inf Div
ATTN: Historian

From 1 Sep 50 to 30 Sep 50 the Inspector General Office was located at Miryang, Korea. Usual Inspector General activities were conducted. Captain Wesley C. Owen, IGD, was in charge of this office. Major Herman C. DuVall, IGD, Division Inspector General remained at Division Forward Command Post.

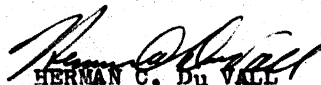
HERMAN C. Du VALL
Major IGD
Inspector General

SECRET

HEADQUARTERS
2d Infantry Division
Office of the Inspector General
APO 243, c/o Postmaster
San Francisco, California

SECRET

6 November 1950

SUBJECT: Historical Report

TO: G2 Section
Hq, 2d Inf Div
ATTN: Historian

1 October 1950 location Miryang, Korea. On 2 October 50 the Division Inspector Generals Office was moved to Chonju, Korea, arriving at 2000 hours 6 October 50. On 13 October 50 preparations were made for movement to Yongdungpo, Korea. Moved by truck convoy from Chonju, Korea to Yongdungpo, Korea on 14 October 50. Inspector General Office at Yongdungpo, Korea this date. During period, this section conducted usual Inspector General activities i.e., inquiries, surveys and investigations as directed by Commanding General, 2d Infantry Division.

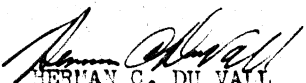
HERMAN C. DU VAIL
Major IGD
Inspector General

PI Sect

PUBLIC INFORMATION OFFICE
SECOND INFANTRY DIVISION

8 October 50.

Subject: Command Historical Report (Reports Control Symbol GSHIS-5)

To: Assistant to Chief of Staff, G-2,
Attention: Historian.

1. Reference Staff Memorandum No. 9, HQ, 2nd Infantry Division, dated 29 August 1950.
2. In compliance with cited reference, Historical Report for the period ending 30 September is enclosed.

C. R. Buckbee

Clifford R. Buckbee,
Major, Inf.,
PIO

1 Enclosure
(Seven copies)

PUBLIC INFORMATION OFFICE
SECOND INFANTRY DIVISION

HISTORICAL REPORT
FOR THE MONTH ENDING SEPTEMBER 1950.

I. Mission

There was no change in the mission of the PIO Section since August 1950 report.

II. Changes In Organization During the Report Period

One NCO correspondent, Sergeant John Scott, was reported missing in action on 1 September following a breakthrough by enemy forces in the 9th Infantry area. No further word of his status had been received by the end of the reporting period.

Two additional personnel losses from the Staff occurred by transfer to combat units.

The Staff performed its missions for approximately two weeks with only five enlisted correspondents present for duty out of eight authorized.

On or about 20 September three replacements were received. All are recent graduates of the Army Information School.

III. Summary of Activities.

The Staff continued its missions of publishing the daily Division newspaper, disseminating information of Division personnel and their accomplishments, and supervising the Liaison Section.

However, in order to offset the lack of civilian correspondents with the Division, daily communiques were inaugurated on 6 September. These were sent to PIO EUSAK and were intended for distribution to Stars and Stripes editor and to newspaper wire services. From one to four communiques were teletyped daily contingent on the amount of information available from G-2 and G-3.

During the last ten days of the reporting period a Stars and Stripes reporter was not assigned to the Division. Daily inquiry in communiques was sent to PIO EUSAK as to the possibility of attachment of a reporter from that media.

PIO Staff correspondents were assigned to all tactical units during the month.

IV. Principal Problems

The lack of promotional possibilities to grades higher than Corporal still existed. (See August 1950 report) The matter was discussed with the Chief of Staff.

The distribution of the daily division newspaper was complicated by the rapid advance of our units with resulting long supply lines. The rear CP where the Warrior is published was more than 150 miles from the leading elements during approximately two weeks. Altho delivery was delayed, it was felt that this was a temporary tactical condition and no change of distribution plan was effected.

SECRET

During the early part of the month, four separate complaints were received relative to non-receipt of the Warrior. These were investigated on the same day the complaints were received. In each case it was found that the Warrior has been received by battalion or similar unit mail clerks and any deficiencies in distribution that may have existed were traceable to the units themselves. Complete reports were sent to the complaining unit commanders concerned.

The problem of satisfactory PIO photographic coverage for the Division as outlined in August 1950 report continued. For example, a splendid opportunity existed for the Division to secure world-wide publicity arose when our troops entered Chonju and found that the Communists had committed mass murder of hundreds of local citizens. The PIO Staff gathered material from the investigating officer and made personal observation of the victims. A splendid feature story was written. However, pictures of the atrocity had been sent by Signal Corps channels together with the negatives to Army Headquarters. It was therefore impossible for this Section to present a consolidated word/picture to the press. After the story had been forwarded to PIO EUSAK for release, the Division Judge Advocate turned over a set of pictures. The captions did not tie in the Division, and it would appear that the Signal Corps had marked them "Confidential". We were not able to find out who issued instructions for their classification. In view of verbal authority received from PIO EUSAK to release this story, we red-lined the classifications and rewrote the captions.

During the last seven days of the month, no telephone, teletype or other contact was available directly with Army Headquarters, and spot news could not be flashed to press representatives. Courier service was utilized thru IX Corps while available.

Following complaints to the Commanding General by unit commanders over the lack of publicity given to the Division in Stars and Stripes, the PIO officer flew to Taegu and discussed the matter with PIO EUSAK. The following items were discussed:-

- (1) The lack of a Stars and Stripes reporter with the Division. We were informed that this would be investigated and possible arrangements made. It was felt that this deficiency might have been caused by necessity of assigning reporters to help with publication of that paper only recently opened in Pusan.
- (2) The comparative lack of coverage devoted to the 2nd Division in Stars and Stripes. PIO EUSAK indicated he would talk to their representative in an effort to have greater equality in future issues.
- (3) Information was requested as to the disposition made of daily communiques sent by this Section, as referred to in Section III, above. It appears our communiques were incorporated in Eighth Army communiques.
- (4) This Section had followed instructions from higher headquarters that units of less than divisional size were not to be publicized except in certain designated cases. Attention was invited to many articles appearing in Stars and Stripes from other divisions mentioning RCT's by specific numerical designation. Permission was received for us to follow this procedure.

SECRET

V. Principal Accomplishments

A total of 580 releases to all types of news media were gathered, written, edited, and mailed during the 30 day period. The Section assisted Signal Corps photographers in special features such as the Al Jolson show, presentation of awards and appointments, etc. and mailed out approximately 100 photographs.

A cumulative total of 1,020 releases were made for the 40 day period this Section has been in Korea.

In spite of staff personnel losses, absence of civilian correspondents, with the Division, and the lack of promotion possibilities for NCO correspondents, it is felt the Staff maintained high esprit-de-corps, and achieved excellent results in news media with the exception of Stars and Stripes.

C. R. Buckbee

Clifford R. Buckbee,
Major, Infantry,
PIO.

SECRET

PUBLIC INFORMATION OFFICE
Second Infantry Division
HISTORICAL REPORT
FOR THE MONTH ENDING 31 OCTOBER 1950

I. Mission

On or about October 20, the T.I. & E. voluntary^{ly} assumed its responsibility of publishing the Division newspaper. This mission had been performed by the Public Information Office since its departure from the United States.

The above change released one correspondent, formerly in charge of publication of the newspaper, to his regular PIO activities.

II. Changes in Organization During the Report Period

There were no changes during the reporting period.

III. Summary of Activities

- 1) PIO staff correspondents were assigned to all tactical units during the month. Their stories were distributed widely throughout the United States and to service newspapers.
- 2) Pursuant to radio instructions from PIO EUSAK, this section compiled a story on the 2d Inf. Division's operations in South Korea. Each major unit was afforded the opportunity to compile and present a digest of their part in the operations. Simultaneously, we conducted research thru the Historical Officer's files, reviewed our communiques to EUSAK, and interviewed commanding officers. Our final draft was presented for review of General Staff Officers and approved by General Keiser.
- 3) The approved story was mimeographed, bound in file folders, and the Indianhead patch pasted on the front. 230 copies of this story were sent to news media throughout the United States. In addition, copies were mailed to service magazines and newspapers.
- 3) Pursuant to instructions from the General, this section drafted a short history of the 2nd Inf. Div. from WWI to the present operations in Korea. This booklet will be printed in Japan and will be given to each new member of the Division with particular ~~emphasis~~ ^{emphasis} to the new members. The draft was approved by General Keiser and taken to Japan by Colonel Teter. At this writing, information has been received that final printing will be completed by November 15.
- 4) In order to provide material for future feature stories, a PIO correspondent was sent to each major unit to write a news story of its activities in South Korea. These write-ups are in more detail than those written for the divisional history referred to in 2) a-above.

IV. Principal Problems

- 1) The lack of war correspondents and Stars and Stripes reporter with the Division was partially offset by the fact that Ivenhoe Advance was located for a great part of the month near Seoul. This enabled us to hand-carry copy to PIO EUSAK for Stars and Stripes and to the Correspondents Billets in that city.
An improvement was noted in the amount of space devoted in the Stars and Stripes to the Division. However, as soon as we moved north, less copy was inserted in the newspaper. No satisfactory reason is known since PIO EUSAK has always been furnished sufficient copy to create a back-log to offset any delay in sending copy thru message center channels.

- 2) Lack of promotional possibilities for the enlisted men of the section continued to provide a morale problem. As an example, Pfc Daniel J. Orr has written outstanding feature stories that have attracted the attention of professional writers, such as Hal Boyle. Orr's writings were instrumental in attracting visits of three correspondents to the Division. In spite of the high quality of his work, his promotion to Corporal is prevented by lack of vacancies in the Headquarters Company.

V. Principal Accomplishments

- 1) The section mailed out 746 releases to news media and service publications during the month. This brought the accumulative total to 1766 releases for the 71 day period this section has been in Korea.
- 2) In addition, 230 copies of the story of the Division's activities were mailed to news and service media.
- 3) A total of 154 pictures (many of them taken under supervision of PIO staff) were mailed to news and service media.
- 4) Approximately 15 cartoons, prepared by soldiers of the Division, were sent to service papers.
- 5) It is believed that the short history of the 2nd Division now in process of being printed in Japan for distribution to all personnel will not only familiarize new members with the division's history but will result in beneficial morale.

C. R. Buckbee
CLIFFORD R. BUCKBEE
Major Infantry
Public Information Officer

Fin Sect

HISTORICAL REPORT
Division Finance Office, 2d Inf Div
Period 1 Sept 50 - 30 Sept 50

Activities: Chronologically

~~SECRET~~

1. Enemy action in the vicinity of the forward CP warranted the employment of a Task Force to which Finance furnished one officer, combat experienced, and ten men, of whom four were combat experienced. The group remained on Task Duty for 22 days.

2. Obtained prices of staples and dry goods available on the Hiryang market. Found that price of rice had trebled in two weeks as a result of dwindling supply, lateness of harvest of current crop, and increase in currency circulation activated by war and American Troops. Forwarded report to Finance EUSAK for coordination with U. N. Funding Officer, and the ECA Director for Korea (see exhibit A).

3-10 Inclusive - routine operations.

11. Secured additional funds from U. N. Funding Officer in Pusan. Received information that one officer and five men of the Korean Army Paymaster Corps would be attached to Division Finance, to accomplish payment to integrated ROK personnel. Made space and security available for their use upon arrival.

12. Alerted all Agent Officers to make turnback of Bank of Chosen 100 Won notes not later than 22 September 1950. Pertinent data was disseminated to company level for protection of all personnel. Conversion was necessitated by enemy capture of 80 Billion Won in 100 Won notes.

13. Routine.

14. Requisitioned Winter Clothing for all personnel.
Funded Finance Officer, of 1 Coy, S.
Rendered efficiency report on officer transferred to 2nd Medics.
EUSAK withdrew authority for Finance Officers to secure Won funds from Bank of Korea in Pusan. Directed that funds be drawn from 8094th FDS in Pusan.

15. G X 21940 limited conversion to 30,000 Won per Person. Set \$20.00 limit on purchase of Won. Checked combat equipment of all men. Found unit fully equipped. Men doing outstanding job of keeping Compound policed.

16. Agent Officer, 38th Infantry Regiment forced to turnback all of \$50,000 roll. Unit moved out shortly after Agents arrival at old area.

Cont.

SECRET

17. Sent Deputy and guard to Pusan for funds. Released two native laborers excess to needs. Checked Miryang market prices and found them rapidly rising.

Indigenous employees of this office had complained to the effect that daily wage did not cover prices of one liter of rice. (See Exhibit B).

Having received an LTR of one Private who drew casual payments in the amount of \$372.00 while enroute from Fort Riley, Kansas to Fort Lawton, Washington, made recommendation to Eighth Army that further action be taken with a view to amending applicable AR and SR to require certificate comparable to that required to open a Temporary Pay Record. Soldier drew three thirty dollar payments at Williams Air Force Base, thus an indication that the system should provide more safeguards for Government Funds.

Korean Army Chief of Finance with a Captain and four men, accompanied by Major Marshall of MUSA arrived at 1715. Orders provides office space and security only. The Chief insisted that Division was to provide everything required.

Under existing conditions such could not be accomplished. Quarters and rations were obtained for them at Korean Army hospital.

18. Routine.

19. Prepared memo covering procedures for ROK Pay Rolls. Reproduced ROK Roll Forms and had them distributed to Personnel Sections.

Disseminated data on Class 2 Allotments required by Dependents Assistance act of 1950. Sending team from Insurance Section to assist in expediting allotment preparations, which must be accomplished not later than 1 Nov 50. Operation effects all grades of pay with dependants.

Refilled Military Pay Records on alphabetical and locator basis to expedite operations. Made locator cards only for evacuees.

Conversion of 100 Won Chosen Notes progressing slowly, due to wide dispersion of troops.

205 dependent travel claims resulting from Division PCS ready for payment, and 245 are working.

21. Received Won Accounting procedures. Dollar Ac can still be required. Settlement of accounts will be accomplished by unified Nations.

22. MUSA advised that Division is ahead of Japan Logistical Command in that it forwards Military Pay Records before JLC can make request for evacuee records. Request will be discontinued.

Commanding General selected an officer of the Finance Corps to be his aide. Officer experienced combat in Europe.

Cont.

SECRET

23. Alerted for move forward.
Equipment and supplies in condition to load rapidly.
 24. EUSAK advised that G.M. approved 40 man T/O for Division Finance, and Forwarded recommendation to D.A.
 25. Requested authority to keep on hand \$500,000.00 to enable funding of Agents who might be unduly delayed in making payments in forward positions.
Distance from funding office increasing.
 26. Routine.
 27. Sent advance party to Changnyong, then received cancellation of move. Truck in accident on return trip. Korean interpreter, Park, Yong Ki, received probable broken back, and severe kidney injury.
Accident reported.
 28. Reset and doing business as usual.
Received new SR 35-30-10, Methods and Procedures for Army Disbursing Officer, Military Pay Section. Prescribed new method of identifying supporting papers initiated by personnel sections.

Received First ROK Pay Rolls from 2d Recon.
 29. Transfer of Won funds advances by SOFAC, EUSAK, and Bank of Korea not accomplished. Wished for delay pending conversion.

Agents for indigenous labor rolls are experiencing great difficulty in effecting payment.

Lawyers still to appear at proper time, on leave for periods unknown.
Result will be a transfer of unpaid accounts to Claims Division.
- S.A.O.
30. Routine Operations.

PROBLEMS AND SOLUTIONS

Shortages of personnel and drop in production resulted from one officer and ten men being required for a period of 22 days duty with a special task force.

Further adding to the production problem was the necessity of providing a constant guard detail, for security of funds and quarters. Demand upon other sections for Task Force Personnel reduced their production materially, however Finance had to increase duty hours to 12 daily. Certain required, but not materially essential procedures were not observed in order to enable current Production and some work on backlog. Office was reorganized as much as possible.

A principal Agent authorized as a B Agent and A Agent in each company is being tried with a view to expediting operations, to simultaneously provide patron service and maintenances of records.

As a result of wide troop dispersion, and lack of efficient phone service, Personnel Sections prepared rosters on which were listed men who desired no payment. Inability of Agent to readily locate men, and refusal of men to accept pay forced agent to hold funds an unusual time, and to make large turnbacks.

The result was excessive duplications of effort in Personnel and Finance Sections.

The Finance Officer had to keep on hand an exceptionally large amount of funds to accommodate Agents and patrons. Partial solution would be larger on more Class E Allotments.

Military Pay Records for KIA and MIA Personnel have not been forwarded within the prescribed 24 hour period.

Units in combat have been unable under prevailing conditions to promptly render strength returns, thus Personnel has not been able to promptly initiate Military Pay Orders as an authority for Finance to forward pay records. Were it not for Class E Allotments in effect many dependents might suffer financial embarrassment before the six month gratuity payment could be made. Daily co-ordination with Personnel Sections has expedited separations, however attempts to contact units were unavailing. Apropos co-ordination with Personnel Sections, close proximity of Finance and Personnel very materially expedites answers to correspondence pertaining to allotments and pay accounts.

Class Q Allotments prescribed as a result of the Dependents Assistance Act of 1950, have been difficult to process, while troops are dispersed and on the move.

To expedite operations, the Insurance Section Personnel have been used as a field team to assist in preparation of Allotments and to bring them to bear.

Cont.

SECRET

The ROK Finance Unit attached to Division Finance has not been available when required, then when on duty did not have funds of proper denomination to fund Agents.

The ROK Finance Officer and personnel of Division Finance were sent into the city markets to exchange 1000 Won notes for lesser denominations as required by change lists applicable to rolls.

Division Finance is not authorized to fund the ROK finance officer now to pay ROK troops on duty with the Division. Recommendations, to authorize the Division Finance Officer, to make all required ROK payments were wired BUSA.

LESSONS LEARNED:

At this time definitive comparison of the old and the new pay system under combat conditions can not be made.

FOR THE DESCRIBED OFFICER:

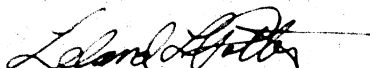

LELAND L. POTTER
WOJG USA
Adm Asst

HISTORICAL REPORT
Division Finance Office, 2d Inf Div
Period 1 Oct 50 - 31 Oct 50

Activities; Chronologically

1. Ceased operations, and loaded office into boxcar at Miryang, Korea.
2. Division Finance Officer was appointed train commander. Troops of Rear Command Post were entrained on Miryang siding at 0800, and the train was cleared to roll at 0852. Arrived at 1100 at Massan station where troops remained until 1900. Kitchen car came in handy! Due to poor equipment, and weak bridges enroute to Chinju, reloaded troops into gondolas, hooked on men and finance cars, leaving baggage cars with guards to follow soonest. Arrived at 2300 at Gunbug station where train was sidetracked ostensibly to await arrival of a train from Chinju. It was later learned that the train crew would take no chances due to nighttime guerrilla activity in the area. Troops built fires in yard where many sat up, while other crawled into sleeping bags.
3. A Filipino unit, sidetracked for four days, offered breakfast, and any other assistance possible. Our mess car was heating water to prepare breakfast. At 0700, finally got train crew to pull three cars of equipment. The grade was fairly heavy, and the engine so worn out that three tries were made to get over. Made Chinju siding at 0900. Trucks were dispatched from Chinju to Gunbug and returned therefrom with the personnel at 1600. Trucks were then utilized to unload the rail cars. Finance gear and personnel were loaded onto eight 2 1/2 T trucks, and jeep with trailer. A Division Finance Office under previous pay system required a maximum of 2 2 1/2 T trucks.
4. At 0835 rolled convoy. Arrived at 1600 at FWD CP in old Camp Dyke on the edge of Chonju. Moved on to Rear CP established in mission school. Billeted Finance in auditorium bearing name of Egbert W. Smith. Got men fed and bedded down.
5. Set up Finance Office in basement of auditorium, and was operational in 3 1/2 hours. Move cost five days operational loss. Pitched 2 squad and 2 pyramidal tents to house finance men. Personnel offices required auditorium space. Inability of Personnel Sections to secure casualty reports and clear KIA records short of a 34 day average, indicates a deluge of paperwork as soon as division closes in Army reserve.
6. Routine
7. Bank of Korea, Seoul, designated limited depository (WCL 45766) (28 Sep 50).
Received authority to obtain Won funds by cashing United States Army Funding Officer's check drawn on the Bank of Korea. Accountability transferred between finance officers, (123.2, EUSAK, 28 Sep 50)
EUSAK letter, 1 Oct 50, 123.7, advised Won exchange rate may be adjusted. Wired KTAG via EUSAK reporting absence of ROK-FIN Section.
ROK Liaison officer visited office, offering such assistance as he had available. Advised him of difficulties with ROK-FIN unit.

Cont.

8. ROK-FIN unit reported for duty. Unit had difficulty in understanding American system of agent operations to include turnbacks. Korean Army allows unit commanders to retain all funds not paid to soldiers. ROK captain requested signature of Division CG on certificate of authority for ROK unit to disburse in area. Request refused on grounds that ROK unit was not assigned to division, and that it had Korean Army authority to operate.

9. Lt. Poczik departed for Suwon for purpose of assisting in executing class 3 allotments for organizations in that area.

10. Received deluge of requests for pay.

11. Lt. Tudder air lifted to Pusan for funds and data on exchange rates. He returned at 1400 hours with funds and authority for conversion of Korean Won from 1800 to 2500 to \$1.00. Conversion was authorized as of 1 October but because of delay in receipt of authority could not be made until close of business today. The US dollar loss because of the change in rate for the 86,740,470 Won on hand was \$13,492.96. This loss was transferred on paper to the US Army Funding Officer in Pusan. Transferred three men to MP unit.

12. Letter HUSAK, AG 322 KGO, 6 Oct 50 authorizing overstrength of finance section, pending publication of new T/O & E, 14-500. Lt. Poczik returned from Suwon at 1500 hours. Lt. Col. Lesley ordered forward to sit as presiding officer of Board of Inquiry.

13. Prepared to move to Yongdung-Po. Operational until 1500.

14. Finance section arrived Yongdung-Po at 1800.

15. Set up office in building, and put men under canvas. Advised that division is under Army reserve on 3 to 5 day alert. 31 Oct pay day may be delayed.

16. All personnel standing reveille and retreat. The requirement that finance personnel stand retreat has resulted in a loss of time that will have to be made up after duty hours, in addition to curtailing the service capabilities of the office. Collections from APO increasing; \$49,000.00 today.

17. Prepared pay lists and funded agents of 15th FA within 24 hours.

18. Notified that approved T/O & E for division finance now provides 2 M/Sgt, 3 SFC, 8 Sgt, 17 Cpl, 8 Pfc, and 2 Pvt slots. No promotion possible due to overstrength in division. Personally notified KMAG and Chief of Korean Army Finance that ROK-FIN unit departed old station 13 1300 Oct 50 and has not reported. U.S. Finance not authorized to pay ROK personnel.

19. ROK-FIN unit reported, and KMAG notified. Recommended Lt. Poczik, Leslie J., QMC, Division Insurance Officer, for BSM for meritorious service with units in combat.

Lt. Rosenberger not promoted even though he holds reserve captaincy, because his date of rank fell outside zone of consideration.

20. Alerted for move up on 27th. Requested information re medium of

Cont.

of exchange to be used north of 38th parallel.

Wired USAFO to expedite check for Won funds.

21. Collaborating in Civil Affairs matters.
22. Furnished clerk-typist to Civil Affairs Section. Appealed to AG-E for quality replacements.
23. Advised staff of probable delay of pay day, due to allotment situation.
24. CINCPAC directed concerted effort to convert funds into dollars for men leaving "script" area.
25. Futile trip into Seoul for Won funds; other offices experiencing same difficulty.
Recent transfers out are proving that: Remaining men can carry load.
Cut is good for morale.
26. Secured 50,000,000 Won by transfer from 105th FDS.
Received notice that GHQ has not approved an exchange rate, now funding procedure to be observed north of 38th parallel.
Chief of Finance advised that Veterans Administration reversed its stand on NSLI applications without physical examination, or certificate in lieu, and applications will be accepted until 1 Jan 51. (WCL 20151, 19 Oct 50)
27. Approved request of Sgt. McAnally for his transfer to 25th Division (his old outfit). Mr. Bark, Korean interpreter injured at Changyong, reported for duty.
Received more than 100 MPR (KIA) erroneously returned to Division from Japan Logistical Command. Immediately returned them.
28. Pvt Rivet requested emergency leave after receiving a letter from his mother telling that his father was near death. He was instructed to obtain immediate verification through the Red Cross.
Forward CP moved up. Readjusted Rear setup.
29. Notification from Red Cross concerning Pvt Rivet's emergency leave received. Transportation will be available tomorrow. Lt. Colonel C. A. Lesley took over as OIC Rear CP during temporary absence Colonel Teter. Pvt Rivet departed this AM for emergency leave.
30. Advised Rear staff that pay day will be delayed one more day as a result of extra police call.
Received check for 200,000,000 Won. Seven days enroute from Pusan.
31. Released three Korean boys whose home is in Miryang. One only need have been released, however, due to age of boys, distance, and probable move forward, decision made to send three together now.

Cont.

Problems and Solutions:

5th. Move up from Miryong cost five days operational loss, and material delay in forwarding of records of personnel KIA. Lack of lighting facilities further impeded progress. Closer personnel supervision, and explanation of the necessity for greater effort pending installation of lights prevented a greater backlog. Men responded with a will to do.

9th. ROK-FIN unit again found to be funded with only 1000 Won notes, thus delaying agent operations. Sent ROK officer and Korean interpreter into Chonju to change some funds into smaller denominations.

14th. Move up to Yongdung-Po cost four more days loss of operating time. Installed separate generator to light office, and required men to work longer hours. Urged closer cooperation and coordination with Personnel Sections. Found such action expedited preparation of 9th RCT pay lists four days.

Lessons Learned:

That, the new pay system, many factors yet to be improved upon, notwithstanding, provides a more expeditious means of paying troops engaged in combat. That, with close cooperation and coordination between unit headquarters, personnel sections and finance officer, further expedition results. That, the proximity of personnel sections to finance further expedites operations, inasmuch as many problems were solved in the matter of minutes, when work was hand carried between offices. Record problems confronting field units are recognized as weighty ones, however, it must be further recognized that administration problems have been concentrated in Personnel Sections to enable greater freedom at unit level.

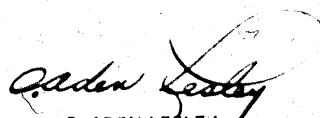
O. ADIN LESLEY
Lt. Col., F.D.
Finance Officer

PM Sect

SECOND MILITARY POLICE COMPANY
Second Infantry Division
APO 248, 5 Postmaster, San Francisco, Calif

SECRET

10 October 1950

SUBJECT: Historical Report.

TO: Commanding General
2d Infantry Division
APO 248, U S Army
Attn: Division Historian

1. In compliance with Staff Memo 9, Hq 2d Inf Div, dtd 29 Aug 50, the following report is submitted:

A. MISSION OF THE PROVOST MARSHAL:

1. Overall supervision of Military Police Activities in the 2d Infantry Division Sector.
2. Direct supervision of Main Supply Route Security, Prisoner of War Enclosures, establishment of Traffic Control Points and Straggler Control points.
3. Supervision and organization of Raiding Parties for Main Supply Route protection.
4. Refugee Control: Processing and moving to pre-arranged areas from strategic positions.
5. Escort and Security of VIP.

B. MISSION OF THE SECOND MILITARY POLICE COMPANY:

1. Furnishing the necessary personnel for Military Police Activities within the 2d Infantry Division sector.
2. Any other function as directed by the Provost Marshal.

C. PECULIAR PROBLEMS ENCOUNTERED AND SOLUTIONS THEREOF:

1. Road Net and conditions:

Due to the obvious inadequacy of the existing road net and the conditions thereof, the problem of maintaining a uniform flow of traffic is ever difficult as well as important.

Many roads are little more than paths, necessitating extreme control measures. The narrowness of roads over mountainous regions has necessitated the use of an abnormal amount of Military Police control.

The harassing of our Traffic Control Points and deriles

by bands of Guerillas has been the reason for the organization of so-called "Flying Squads".

SECRET

One way defiles have been throughout the Sector to maintain a uniform Traffic Flow. One Seven (7) mile stretch of treacherous mountain road, TCPs with five (5) Military Policemen each are at the ends of the defile, and at the center point, another check point is maintained. Field Telephone communications between Points for the control of Traffic has been successful insofar as Guerilla activity has been suppressed. Guerillas have cut wires every ten (10) feet, completely destroying field telephone communications. The addition of radio-equipped $\frac{1}{2}$ ton trucks to patrol the defile has aided in accomplishing both Traffic Control and suppressing Guerilla activities.

Table of Organization and Equipment Radios have been useless in this mission because of the terrain. Through the co-operation of the 2d CIC Detachment, three (3) Motorola (AN-VRC-2) radio equipped $\frac{1}{2}$ ton trucks have been utilized for patrol purposes. The praises for this radio cannot be sung too loud. The inadequacy of the TO & E Radio in this terrain has amplified the need for a Motorola type Radio as T O & E.

The addition of a twenty-four hour Road Reconnaissance Patrol on the Main Supply Route, in addition to the normal Traffic Control points, with the mission of aiding traffic flow in possible bottlenecks caused by larger vehicles such as Tanks, Heavy Wreckers, and so forth, has greatly aided in maintaining a uniform flow of traffic.

To suppress Guerilla activity which constantly threatens the Main Supply Route Security, "Flying Squads", part of the specially organized "Ivanhoe Security Force" are dispatched to scenes of Guerilla activity. The "Flying Squads" consist of Military Police, Korean National Police, under the command of Major Jack Young. In constant touch with Military Police activities on the Main Supply Route, the "Flying Squads" are ready at a moment's notice to go to the scene of any Guerilla activity. They further patrol the mountains adjacent to the Main Supply Route, mopping up Guerilla activity and reporting any large enemy concentrations or fortifications.

Through the co-operation of the Division Air Section, a helicopter has been made available from time to time to patrol the Main Supply Route. Checking Traffic Control Points by air has revealed flaws and mistakes ordinarily unobserved or overlooked on the ground. By this means, Guerilla activity on the Main Supply Route has been spotted and squelched in the bud.

2. GUERRILLA ACTIVITY:

The ever present threat to our supply lines and rear installations of attack by Guerillas and NKPA Troops disguised as refugees has been combated with great success by a method developed in conjunction with the Operations Section, IPW Team and the 2d CIC Det.

Through leads furnished by refugees, an idea of how the NKPA and Communist Guerillas have operated behind our lines have been become known.

An example of their tactics is outlined below.

A group of NKPA Troops of company size crosses our lines by means of various subterfuges, such as under cover of an artillery barrage or in the wake of a so-called "Banzai" charge. Once across our lines, the group dons civilian clothing and splits up, joining Refugee movements. They travel with the refugees until the movement reaches a pre-arranged rendezvous where they absent themselves and gather to re-don their uniforms and strike out to perform the missions assigned them.

SECRET

To combat this, several methods were devised, and failed miserably. On the 25 August 1950, at a joint meeting of the FM Operations Section, IFW Team, CIC and the Korean CIC, the present plan was devised.

The Korean CIC furnished the necessary agents, who disguised themselves as refugees and joined various refugee movements throughout the sector. The mission of these agents was and remains, to seek out information prevalent in refugee movements. The agents are unknown to Military Police, and cannot be recognized except for various signals known only to Military Police. Upon recognition, the agent is taken from the movement and taken to IFW, where the information he has obtained is evaluated.

Through this means, Guerillas and NKPA troops have been uncovered and apprehended before they could inflict any damage on our supply lines or near installations or before their plans can materialize.

3. REFUGEE CONTROL:

The abnormal amount of Refugees encountered in this operation has made Refugee Control extremely difficult. In a period of ten (10) days, over 100,000 refugees were screened by Refugee Screening Teams. The refugee problem, in conjunction with the Guerilla and NKPA practice of donning civilian clothing and joining refugee movements in order to infiltrate through our lines has made it extremely hazardous as well.

A solution to this problem has been developed by the Operations Section of the Provost Marshal's Office. It has worked extremely well in actual practice, resulting in a rapid refugee disposition. As an illustration of its worth, the following case is cited:

On the 3 September 1950, the Police of Yong-San reported a projected movement of 30,000 refugees to Susan-Ni. With the assumption on our part of the possible presence of enemy agents in the midst of the refugees, the Yong-San Police were instructed to halt the refugees and direct them to an open field or river-bed, pending the arrival of a Refugee Screening Team. The Refugee Screening Team, one of several developed through experience, consisted of four (4) Military Policemen, a Non-Com in charge, Two (2) Mine Detectors, with operating personnel, furnished by the 2d Engr C Bn. an Interpreter and Thirty (30) Korean National Police, was immediately dispatched to Yong-San.

Upon the arrival of the team at Yong-San, Liaison was immediately established with the local police, who were utilized in the screening process. The Police in the Team were deployed in strategic positions so as to form a perimeter around the refugees. Six Police from the team, the Interpreter, Military Police and Mine Detector personnel then funneled the refugees thru:

Team and Local Police, whose functions were to check papers and identification, then thru the Mine Detectors, which were passed over their bodies and bundles, if any. The presence of any metallic object as determined by the Mine Detectors was cause for the undressing or unpacking of bundles by Military Police and the interpreter, of the person or bundle in question. The entire process was under the complete control of the Military Police present.

Upon the completion of the Screening, which took approximately twenty-four hours, the movement was split up into groups of 5000 or more, and then directed to proceed by means of a secondary road and open fields to a pre-arranged assembly area. Each group was preceded and followed by two (2) Policemen from the Tam Police. At the assembly area, a representative from the South Korean Government marshalled and oriented the refugees for the movement from the Division Sector. All responsibility for the refugees was assumed by the South Korean Government at the assembly area. For those refugees who, by reason of age and infirmity, were unable to keep up with the main body, a truck was made available from the Military Police Company for their movement to the assembly area.

For the effective application of this solution, close co-operation was necessary between the Military and the Korean Government.

The use of Korean National Police was and remains extremely desirable, both from the language viewpoint and manpower situation.

The issue of orders restricting refugee travel to daylight hours has greatly decreased any accidental shooting by nervous or over-expectant troops, as well as having an effect on Guerilla infiltration. Establishment of a curfew at 2100 hours each night for the civilian populace has also reduced Guerilla activity noticeably.

In addition to other refugee control measures, leaflets have been devised and dropped by plane. The leaflets state in substance, that they must comply with all regulations as dictated by martial law; that in order to avoid confusion and possible tragedy, they must not travel at night; they should stay in orderly groups, reporting anything that may be of any tactical or strategic use to UN Forces as quickly as possible, and that attempts to feed and shelter them would be made by the Korean Government.

4. UNIT WAR DIARY: (1 Sep 50-30 Sep 50)

1 Sep 50- Normal field CP Duties. Patrol dispatched to investigate reports of enemy roadblock on Miryang-Pogong-Lyon road. Contact was not made, but additional patrols were maintained. Guerilla Snipe-fire hampered traffic, but attempts to capture them are not too successful, each patrol netting very few guerillas. Entire company committed to combat.

2 Sep 50- Cpl Clyde S. Ford was killed in action in the vicinity of Udon, Korea. Cpl Ford was escorting a convo when they were ambushed by an unknown number of Guerillas, using automatic weapons. Cpl Ford was shot four times in the chest, and died instantly. Traffic Control Points in Yong-San were strengthened by the addition of 2 M. Military Police were forced from Traffic Control points by enemy actions, but later, while still under heavy enemy fire, regained control of traffic. Sgt E P Parker and Cpl J C Howard

5

distinguished themselves in action on this date. Sgt Parker and Cpl Howard were instructed to quit their post in the event of an imminent enemy encirclement or capture of Yong-San. When the enemy captured Yong-San, they volunteered to remain at their posts in order that friendly traffic would flow smoothly from their positions. When Yong-San was completely empty of friendly traffic, and was completely captured, Sgt Parker and Cpl Howard withdrew with Infantry units to a point overlooking the town, and joining an Infantry unit, helped hold the hill until Friendly forces could re-organize for counter-attack.

3 Sep 50- Sgt Parker and Cpl Howard advanced with Infantry units into Yong-San, aiding in the re-capture of Yong-San by American Troops, and personally accounted for over ten (10) enemy dead. In the face of intense enemy artillery and small arms fire, they resumed control of their post, directing traffic and information to advancing American troops.

4 Sep 50- At 0200, in the town of Urdong, Korea, on the Division North MSR, a group of guerillas attacked a Traffic Control Point. Alert guards of the Second Platoon opened fire, killing one, before the enemy could attack. Identification revealing the dead enemy as a NKPA Soldier was found on his body. During the fray, hand grenades were thrown into Military Police positions, injuring four (4), Sgt R L Myers; Cpl Miller, C R; Pfc D L Miles and Pfc J M Bazel, all of whom suffered shrapnel wounds. A sustaining fire, laid down by Cpl R R Tellinghuisen's carbine, drove off the enemy. Several enemy were known to have been wounded, but were removed by the enemy as they withdrew.

5 Sep 50- The Traffic Control Point at Urdong was again attacked by a number of Guerillas, who attacked with hand grenades from the top of a steep hill overlooking the Traffic Point. The attack was repulsed by rifle and machine gun fire. Rifle grenades then dispersed them. Later in the evening, the enemy again attacked, but were driven off by a concentrated fire which killed two (2).

6 Sep 50- The traffic control point at Urdong was strengthened by the addition of men and weapons, and at 2300, was again attacked, but being prepared, drove off the enemy, killing two and with no losses for the Military Police. Ivanhoe Security Force assumed responsibility for the security of the MSR. A Patrol checking the Division Air Strip discovered Guerillas attempting to destroy the Strip and Planes. In the ensuing struggle, six (6) enemy were killed and the others driven off.

7 Sep 50- The Traffic Control Point at Urdong again attacked, but the enemy was driven off. Normal duties for the remainder of the company and B1 Section.

8 Sep 50- Rains have turned roads into quagmires, necessitating additional traffic Patrols and stringent control measures. Refugees continue to be a threat to rear security because of NKPA practice of donning civilian clothing and joining refugee movements. NKPA infiltration has caused communications breakdowns and unnecessary casualties. To date, One (1) MGR EA has been killed, two (2) have been wounded, and two (2) are missing. Over 100,000 refugees have been screened and evacuated from the Division Sector. Use of a line detector and operating personnel from the 2d Sgr C Bn. has greatly speeded the screening of refugees.

9 Sep 50- Road conditions remain poor, causing traffic accidents that impede traffic flow. Other duties of the Company and Pl Section remain the same.

SECRET

10 Sep 50- Normal duties.

11 Sep 50- Normal Duties.

12 Sep 50- Normal Duties.

13 Sep 50- Normal Duties.

14 Sep 50- Normal Duties.)

15 Sep 50- Normal Duties.

16 Sep 50- The entire Division was committed into a full scale counter-attack which necessitated the re-establishment of Traffic Control Points, Straggler Collecting Points and Prisoner of War Enclosures in towns where we previously were driven from. Traffic Control was stringently enforced and maintained, with full priority given to forward moving vehicles. Strict blackout ordered and maintained. Heavy rains commenced at 2800 hours.

17 Sep 50- Approximately 300 refugees were removed from the Div Arty CP area and evacuated to Susan-ni by the Third Platoon. The Second Platoon reported roads in very poor shape because of heavy rains. Two North Korean soldiers dressed in civilian clothing were captured by Military Police at Yong-San.

18 Sep 50- The Traffic Control Point at Undong was again attacked by an estimated 20 to 25 guerrillas. The attack was repulsed with no casualties to this unit and none known of the enemy.

19 Sep 50- Company and Pl CPs moved to 1149.8-1094.7 from Susan-ni. Traffic points on the Southern MSR were assumed by the 612d LP Co. Roads in good condition.

20 Sep 50- Guerilla activity was reported on the Northern MSR in the vicinity of Undong. Ivanhoe Security was dispatched for action. The Second Platoon crossed the Nakdong River to establish TCFs. TCFs at the bridgehead were also established.

21 Sep 50- All posts were inspected by the Commanding Officer. At the bridgehead, vehicles were being ferried across the river, pending the completion of the bridge. A patrol captured three (3) enemy in a firefight.

22 Sep 50- The Second Platoon was posted at the bridge site and assumed control of traffic thereat, and established a PW collecting Point, from which prisoners were removed to Changyong PWS.

23 Sep 50- Normal Duties.

24 Sep 50- Company and Pl CPs displaced forward to Tugong-ni (1130.7-1200)

SECRET

from Changyong (1149.5-1094.7), where Traffic Control Points and a Prisoner of War Enclosure was established. PWE and TCF at Yong-San closed out and displaced forward to this area.

SECRET

25 Sep 50- Pfc R W Baker was wounded in action when the Traffic Control Point (1153.0-1401.2) at which he was posted was attacked by enemy components using automatic weapons and hand grenades.

26 Sep 50- Company and EM CPs displaced forward to Hyapchon (1401.5-1115.2) from Jagong-Ni. Traffic Control Points were established at the Hwang River crossing.

27 Sep 50- No change in duties.

28 Sep 50- Company and EM CPs displaced forward to Anni (1408.1-1081.1) from Hyapchon. Patrols were dispatched south at 2000 hours and contacted Military Police of the 28th Infantry Division.

29 Sep 50- Regrouping and re-establishing Traffic Control Points and PW Enclosures occupied most of the Company and EM Section.

30 Sep 50- Lt Sexton, Asst EM, with a Platoon displaced forward to Chonju to establish Traffic Control Points and Command Post Area, while no change in duties occurred for the Company and EM Section.

Thus ended the month of September 1950. Normal duties were predominant throughout the month. Morale remained at a high level, rising with the rapid advance of UN Troops and the growing amount of good news.

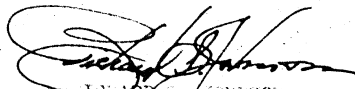
LEONARD S. JOHNSON
Captain 1FC
Commanding

SECOND MILITARY POLICE COMPANY
Second Infantry Division
APO 248, Postmaster, San Francisco, Calif

1 November 1950

SUBJECT: Command and Unit Historical Report.

TO: Commanding General,
2d Infantry Division
APO 248, U S Army
Attn: Division Historian

1. In compliance with Staff Memo 1, HQ 2d Inf Div, dtd 25 Aug 50, the following report is submitted:

A. MISSION OF THE PROVOST MARSHAL:

- (1) Overall supervision of Military Police Activities in the 2d Infantry Division sector.
- (2) Direct supervision of Main Supply Route Security, Prisoner of War Enclosures, establishment of Traffic Control Points and Straggler Control and Collecting Points.
- (3) Supervision and organization of Military Forces for Main Supply Route protection.
- (4) Refugee Control: Processing and moving to pre-arranged areas from strategic positions.
- (5) Escort and Security of VIP.
- (6) Supervision of Prisoner of War Camps in Pongjeng.

B. MISSION OF THE SECOND MILITARY POLICE COMPANY:

- (1) Furnishing the necessary personnel for Military Police Activities within the 2d Infantry Division Sector.
- (2) Any other function as directed by the Provost Marshal.

C. PRISONER OF WAR CAMP ENCLOSURES AND COLLECTIONS POINTS:

- (1) Prisoner of War Camps.

Upon arrival at Pongjeng, this unit was charged with the responsibility of Operation of Prisoner of War Camps in Pongjeng.

Since the Prisoner of War camps were in the process of starting, the problem of maintenance became apparent. The Camp had to be reorganized. Battery "A", 66th AAA AF Bn (SP) (107th AB/AS) was charged with the security of the Camp, with Military Police acting in an advisory capacity. Since this responsibility was assumed on the 30 October 1950, not enough time has passed to fully report on this phase of Provost Marshal responsibility.

D: UNIT WAR DIARY.

1 Oct 50-Departed from Anju (1400.1-1001.1) for Chonju (1010-1401) at 0700. Arrived 1200 hours. Traveled 86 miles. Traffic Control Points, Straggler Control and Collecting Points, Prisoner of War Enclosure established enroute. Town Patrol established in Chonju.

2 Oct 50 to 7 Oct 50. No change in duties.

4 Oct 50- Second Platoon crossed Kuk River to establish CP's.

6 Oct 50- Departed Chonju (1010-1401) for Kogju (0840-1127). Traveled 89 miles. Traffic Control Points established enroute.

9 Oct 50- Departed Kogju (1014-1110) for Sawon (0840-1127) Traveled 70 miles, with Traffic Control Points established enroute.

10 Oct 50- Departed Sawon (0840-1127) for Kogju-ni (0100-1141). Departed Kogju-ni (0100-1141) for Koryang-ni (0100-1100) total distance traveled: 80 miles. Upon arrival at Koryang-ni, Traffic Control Point Information Posts, and Patrols were established in nearby Koryang P.O.

11 Oct 50-17 Oct 50. No change in duties.

15 Oct 50- Sgt E V Parker awarded Silver Star for gallantry in action on 1-3 Sep 50. Sgt S F McClure awarded Bronze Star for action on 6 Sep 50. Patrols escorted thru CP's north of 36th Parallel, a total of 89 miles.

19 Oct 50- Sgt E V Parker was first American Soldier to enter P'yongyang, North Korean Capital. Sgt Parker was with "Task Force Indiamen".

20 Oct 50-26 Oct 50. No change in duties.

27 Oct 50-Departed Koryang-ni for P'yongyang. Traveled 108 miles, and stopped overnight in school yard.

28 Oct 50-Departed overnight bivouac area north P'yongyang. Total distance traveled from Koryang-ni to P'yongyang: 178 miles.

29 Oct 50- Patrols north and south of P'yongyang established.

30 Oct 50- Supervision of Prisoner of War Camps assumed. Town Patrol established, with 24 AF desk in P'yongyang City Jail.

31 Oct 50- No change in duties. At 2200, 2 Prisoners attempted to

escape from Prisoner of War Camp # 2, but were shot down in the attempt. One was immediately killed and the other died of his wounds an hour later.

E. REMARKS:

Normal field duties occupied this unit during the past month. Morale continues at a high level. It is felt that the lack of activity was due to the use of the 2nd division in reserve for the greater part of the month.

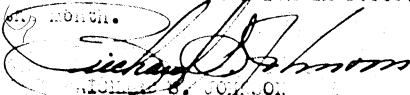
RICHARD S. JOHNSON
Captain, 1st PG
Commanding

Sp SV Sect

HISTORICAL REPORT
DIVISION SPECIAL SERVICE
2d Infantry Division APO 248

For the period of 1 to 30 September 1950

On 1 September 1950 the 2d Infantry Division Special Service Officer was put in command of a "Task Force" composed of Bandsman and clerks from the Division Rear, with the mission to defend two mountain passes on the main Supply route. On 8 September the mission was completed and "Task Force Strom" returned to the Division Rear and assumed normal duties.

On 8 September the prepaid Class VI ration for the Division arrived under guard from Japan, and an immediate breakdown of 940 cases was made to all units participating in the purchase.

On 17 September, publicity was forwarded to all units not actually engaged in combat, announcing the personal appearance of "Al Jolson" at the 8076 M.A.S.H. in Miryang. Preparations were made for the construction of a stage, and arrangements for air transportation was approved by G-3, Air, to transport Al Jolson to the 2d Division area, from the 25th Division area in Masan. On 18 September, approximately 800 Officers, EM, and patients attended the Jolson Show. Al Jolson's personal appearance was received with much enthusiasm and proved to be a great morale booster.

On 19 September, a touring ROK Special Service Show was contacted and arrangements were made to have the show perform for the following units of the 2d Division; 2d Bn. 9th. Infantry Regt., Division Rear, 8076 M.A.S.H., and the 72d Heavy Tank Bn. Combat activities prevented the show from visiting other Divisional units. This show was also received with much enthusiasm. Arrangements were made for more appearances at a later date.

The 2d Medical Bn., was visited each Sunday afternoon and over 240 one-tenth ounce Whisky "Minatures" were given to patients designated by the NP Medical Officer in charge.

During the period 1 to 30 September approximately 95,000 Stars and Stripes, and 20,000 assorted magazines and books were distributed to all units. Distribution was made on the basis of three (3) to front line units against one (1) to rear area units.

The Special Service Post Exchange operated a bulk sales store to supply front line troops and a retail store, located at Division Rear, for the convenience of replacements and rear echelon troops. The Post Exchange sold over thirty thousand (\$30,000.00) in merchandise to Division troops. The combined efforts of the entire section were required on many occasions to move and guard supplies and assist in filling orders and making sales.

SECRET

SECRET

Historical Report, Division Special Service, 2d Infantry Division, Cont'd

The Special Service Section supplied movie film and projectors to all units who could show movies. As front line units were generally unable to use these services, priority was given to the 2d Medical Bn. clearing station and the 8076 M.A.S.H. Hospital. Approximately thirty thousand (30,000) personnel attended all movies shown during this period.

On 20 September M/Sgt Lester McVey and SFC Elmer McCorkle were assigned to the Special Service Section for duty with Post Exchange.

During the month of September the 8th. Army Special Service Officer and Pusan Logistical Command Special Service Section were contacted on numerous occasions by personal visits and by telephone in an attempt to draw much needed athletic supplies, radios, movie projectors, and writing paper. However, up to the end of the period none of the urgently needed items were received.

In an attempt to alleviate the writing paper shortage, merchants in Miryang, Korea, were contacted to make envelopes which were subsequently distributed to front line units. Until the necessary supplies of writing material is furnished through supply channels this method of supply will continue in effect.

Although magazines and books were supplied during the period it was felt the Supply was not sufficient, therefore 8th. Army Special Services were contacted in an attempt to double the issue. At the time of this writing notification had been received that approval for an increase of reading material had been granted and would commence with the next issue.

On 30 September 1950 preparations were made to pack all equipment and Post Exchange supplies for movement to Chinju, Korea.

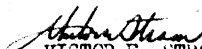
VICTOR E. STRON
Major, Infantry
SSO

SECRET

**HISTORICAL REPORT
DIVISION SPECIAL SERVICES
2d Infantry Division APO 248**

For the period 1 to 31 October 1950

During this period the Special Service Section in four moves was to travel over 500 miles from Miryang in South Korea, to Pyongyang in Northern Korea. On 2 October, the section departed from Miryang by vehicle and rail for Chinju, 90 miles to the West. While at Chinju arrangements were made to send the Post Exchange personnel and merchandise to Pusan, to remain until rail transportation to Seoul became available. The remaining personnel of the section left Chinju by vehicle to Chonju, 105 miles to the North, on 5 October. The stay at Chonju was of short duration. On 13 October a move was made to Noryang-Ni, 140 miles to the North (5 miles South of Seoul) location of the 2d Division Headquarters. On arrival, the assistant Special Service Officer and the Chief Clerk, together with three (3) guards, departed from Kimpo airport at Seoul for Japan to procure class VL supplies for the Division. The Post Exchange arrived by rail on 17 October and immediately began making bulk sales to units. The section remained in this location until 28 October at which time the Special Service Officer and three (3) enlisted men moved forward with the 2d Division Headquarters to Pyongyang, 180 miles to the North, across the 38th parallel. Two (2) Officers and four (4) enlisted men, including the Post Exchange personnel, remained with the 2d Division rear at Noryang-Ni. The section was so located at the close of the period.

The Post Exchange continued to operate both bulk sales and individual sales stores, whenever possible. Sales for this period totaled over \$40,000. However, urgently needed items such as razor blades, candy, cigarettes, tooth paste, soap etc. could not be drawn from the Pusan Central Exchange warehouse because these items were issued gratuitously through Quartermaster channels.

Due to the non-availability of stationery through military channels, this section in an attempt to procure much needed envelopes for front line units, contacted Korean merchants in several cities, along the route of advance, to make 35,000 envelopes which were subsequently distributed to units of the Division. While at Pyongyang 100,000 envelopes and 200,000 sheets of writing paper were found, however, distribution had not been made at the close of the period.

The section supplied movie film and additional movie projectors to units who were able to show movies. Priority for use of projectors and film was given to front line units. An estimated 150,000 personnel attended all movies shown. Difficulties in providing all desired services were encountered due to lack of sufficient projectors and spare parts, and movie film.

SECRET

Historical Report, Division Special Service, 2d Infantry Division, Cont'd

Many attempts were made to draw athletic supplies and other recreational equipment. Although twenty (20) radios and six (6) movie projectors were obtained, the supply was still inadequate. Some athletic equipment was purchased on the local market in Seoul, but here again, stocks were insufficient to meet demands. The section salvaged and distributed 1,000 pairs of "Horse-shoes" found in a burned out building near Seoul.

Upon arrival at Noryang-Ni, the first real opportunity to bring entertainment in the form of stage shows to Divisional personnel, presented itself. Many shows, featuring both American and Korean entertainers, were scheduled for numerous appearances. Among the most popular were the "Bob Hope" show which played in Seoul, on 23 October, before an estimated 4,500 men of the 2d Division and the "Ramblin Roundup" show (see incl 1) which presented four showings in the Division area before crowds estimated at 16,000 persons. The Korean shows engaged were also enthusiastically received, especially those featuring girl vocalists singing American songs.

Another service provided by the Special Services during the period was the operation of a souvenir "Gift Shop". Such Korean made items as lacquered boxes, brass works, silk cloth and ladies pajamas, etc., were offered for sale.

At the conclusion of the period, plans were being made to move the balance of the section, and the Post Exchange merchandise, to Pyongyang from locations at Noryang-Ni.

Victor E. Strom

VICTOR E. STROM
Major, Infantry
Special Service Officer

SPECIAL SERVICES ROAD SHOWS

NEWS RELEASE FOR IMMEDIATE PUBLICATION

First entertainment unit in Korea is the SPECIAL SERVICES ROAD SHOW "RAMBLIN ROUNDUP" bringing an all-western hillbilly stage show to airmen and soldiers and sailors of the United Nations force. A special "flying unit" is bringing entertainment directly to the troops in Korea and is equipped to perform anywhere from the "wide open spaces" to the back of a jeep.

The day following announcement that American troops would be fighting in Korea, the entire cast of "WESTERN JAMBOREE" volunteered to entertain in the combat areas. Brigadier General Paul B. Kelly, Special Services Officer, Far East Command, stated that the cast of the show would be given the opportunity to be "first in Korea" and completed arrangements for the unit to be transported direct to the fighting front.

"RAMBLING ROUNDUP" presents an all stateside cast of musical favorites who have been performing the hillbilly show, "WESTERN JAMBOREE" to record crowds throughout the Far East Command during the past nine months. FEATURED PERFORMERS INCLUDE:

"DOC" HOLLIDAY, singer of Western songs and ace performer on electric guitar. "Doc" hails from Travis County, Texas, and is known to Stateside Western fans through his many appearances with name bands of Texas and California. A three-year hitch in the Navy saw him entertaining on land and sea throughout the battle areas of World War II.

GUS WATT??? comic and string bass player from Fall River, Massachusetts, has been a popular favorite of vaudeville, night clubs and tent shows throughout the United States. His performances before service-

men have garnered laughs and applause throughout the Far East Command.

"COUSIN MASON" on the steel guitar is from down Houston, Texas, was. His recordings with Horace Heidt and broadcasts over NBC with Dudo Martin, Ray Wade, and Roy Shield has made him a favorite of the airways.

WOODY BAILEY has tickled the ivories all the way from his hometown in Bertram, Texas, to the top name western bands of the southwest including the Melody Kings, Harmonizers, and the Six Cowboys. A hitch with the Navy brought his music to thousands of veterans of World War II.

ART YORS has been beating the skins since a lad in his home town of Sacramento, California. His outstanding technique has earned him plaudits wherever he has performed. He was with the Ted Fio Rito band and his travels have taken him throughout the US and on a band tour of Australia.

The special unit of "RAMBLIN ROUNDUP" will return to Japan upon conclusion of the Korean tour and will be augmented with additional entertainers for bookings throughout the Far East Command.

Special Services Road Shows currently present three, ten person units of professional entertainers and are made available to Armed Forces personnel of the Far East Command by Special Services Section, GHQ.

Shows have been touring throughout Japan, Okinawa, Philippines and Guam since arrival from the United States in January. Headquarters are in Tokyo where the units are produced under the direction of Edward Sheffield Stephenson of Los Angeles, Calif., who is Director of Entertainment for the Far East Command.

SJA Sect

HISTORICAL REPORT
Division Staff Judge Advocate
2d Infantry Division

For the period 1 September - 30 September 1950

During the entire month of September, the Ivanhoe (REAR) Command Post remained situated at Miryang, Korea. The Division Judge Advocate activities settled into somewhat of a static routine with the investigation of War Crimes atrocities being classified as the activity toward which the greatest number of man hours were devoted.

Lt. Colonel Ellis received his promotion to Colonel effective on 7 September and entertained the Division Headquarters Officers at a cocktail party and the enlisted personnel with a beer "bust".

At 0914 hours 1 September the Task Force Strom and Defense Platoon No. 2 (REAR) were called upon to move to Ivanhoe Forward CP to strengthen the Defense of that position which had been threatened. The units moved out at 1000 hours taking all available ammo, B & C Rations, all automatic weapons, grenades, grenade launchers and all available rocket launchers. Two officers of this Section accompanied the Defense Forces, Captain Habbitt as Executive Officer of the Task Force and Captain Stenhouse, Commander of Defense Platoon No. 2. Major Ivory accompanied the troop movement to act as an escort and return the REAR transportation to this CP. Major Ivory returned at 1602 hours.

Colonel Ellis was absent from this station on 1 September on TDY in the Pohang-Jong Area, conducting an investigation of an incident concerning 1st Lt Ellison C. Wynn, 9th Infantry Regiment, pursuant to the direction of General Keiser.

Historical Report, Div. SJA, cont'd

Corporal Tanner was absent from this station on 1 September on TDY to Tokyo, Japan, acting as guard escort for Asst Special Services Officer.

Major Ivory departed this station at 0740 hours 2 September to accompany a movement of elements of the 1st Marine Brigade to the 9th Infantry Area and return certain trucks and equipment to this area. Returned at 1557 hours, mission accomplished.

Colonel Ellis returned from Pohang-dong by air at 2110 hours 2 September, his mission successfully accomplished.

A torrential rainstorm hit the CP at about 1900 hours 3 September causing some damage and flooding all flat areas. Rain subsided at 2225 hours.

On 4 September Colonel Ellis and CWO Phillips visited the 2d Division Forward CP, and the 9th Infantry Service Company, and Task Force Strom delivering replacements to the 9th Infantry Regiment, supplies to task force personnel and completing the investigation on 1st Lt Wynn, 9th Infantry.

Colonel Ellis and CWO Phillips took supplies, mail and equipment on 5 September to Task Force Strom personnel. Weather was exceedingly bad excessive rains, cloudy, warm. Personnel of the 1st Marine Brigade were serviced by this section for Powers of Attorney and other legal assistance. A 36 volume Law Library was received from: The Army Library, Law Branch, Room 1A 522, The Pentagon, Washington D.C. (HUBERTA A. PRINCE, Chief, Law Branch.) This library was requisitioned on 1 August 1950, just prior to the departure of the 2d Div from Ft Lewis, Washington.

On 6 September Colonel George H. Hickman, Jr., JAGC, Command Staff Judge Advocate of GHQ Far East Command, Lt Colonel William R. Smoak of the

Historical Report, Div. SJA cont'd

SECRET

Command Staff Judge Advocates Office, GHQ, Far East Command, and Lt Colonel Chester D. Silvers, Eighth Army Staff Judge Advocate, visited this section and discussed various problems of the Division Staff Judge Advocate Section. Colonel Ellis and CWO Phillips visited the 9th Infantry Regimental CP and the 2d Engineer Combat Battalion CP in connection with the investigation of the Lt Wynn Case. Captain Crawford, Commanding Officer, A Company, 2d Engineer Combat Battalion made a sworn statement in connection with the said case. As an incident to the trip, the AG Postal Section Personnel was delivered to Service Company, 9th Infantry for the purpose of serving that unit and area.

War Crimes investigations will be discussed briefly and individually.

On 14-15 September the case of the "Murder of the Surrendered Medic" came to the attention of this office. A Soldier of Company A, 9th Infantry Regiment made a sworn statement to the effect that on 14 September 1950 he saw a "Medic" by the name of "Burch", who had surrendered, held by 2 North Korean Soldiers while a third enemy soldier shot him in the face with a "burp" gun. However on 23 September information was received from the Assistant Adjutant, 9th Infantry that E. Theodore A. Burch RA 15 282 204, Co. A, 9th Infantry Regiment was picked up in Yong-san, Korea, in a very weak condition. He had been a Prisoner of War for five days. Case is being held in abeyance pending authentication of Burch's status.

The days of 14th, 15th and 22d of September were utilized in the investigation of the atrocity case, "Burning of American Wounded". Sworn statements of two Sergeants in Company C, 9th Infantry Regiment alleged that on the night of 31 August - 1 September 1950, elements of the North

Historical Report, Div, SJA cont'd ~~SECRET~~

Korean Army overran the CP of Co. C. After the withdrawal of the able bodied Americans, the enemy built a large bonfire, accelerated it with gasoline or kerosene and threw wounded American Soldiers on the fire, burning them alive.

On 22 September 1950, a patrol composed of Colonel Ellis, Division Staff Judge Advocate, Captain William H. Gibbens, O 439 472, Infantry, Commanding Officer, C Company, 9th Infantry Regiment, Pfc Serafin Ramos, C Company, 9th Infantry Regiment, CWO Carl E. Phillips and Sgt Joseph E. Tanner, both of the Judge Advocate Section, 2d Infantry Division explored the site of the Company C CP on the night of 31 August - 1 September 1950 located on a hill top between Aji-ri and Suijon ni-aji, Korea. A very careful inspection was made of the entire area of the CP and also of two adjoining hills. No evidence of any fires were found, not even of a small camp fire. A thorough search was made for dead bodies both American and North Korean, and none were found in the area of the CP. From all visible signs and indications this was the first American patrol into the area. Therefore it is not believed that a Graves Registration team had previously combed the area and removed bodies. In view of this disclosure the files on the "Burning of American Wounded" case were closed on 24 September 1950.

Colonel Ellis, CWO Phillips and Sgt Tanner visited the CP of Co M, 38th Infantry Regiment on 22 September in connection with case of the "Decapitation of the American Soldier". The sworn statement of a Master Sgt from that unit indicated that on the night of 7-8 September the North Koreans captured the position occupied by Co M, and that on the 17th of September when the same position was retaken by Co M of the 38th Infantry

Regiment the body of Corporal Ashe was found by Lt Sam Rutherford, Private Charles Allen and Marcus James. The body had been beheaded. Investigation on this case is continuing.

On 18th, 19th, 20th and 24th of September the case of the "Murder of 20 Surrendered American Soldiers" was investigated. Statements were procured to the effect that on the night of 31 August 1950, Company B, 23d Infantry Regiment, 2d Infantry Division, was overrun by elements of the 2d Rifle Division, North Korean Army. The unit withdrew and dispersed. On the following morning (1 Sept 50) a group of about 35 or 40 men from Company B, 23d Inf Regt had withdrawn to the vicinity of Lake Upo, to the south. They were withdrawing in the cover of a ditch in a rice field. At about 0830 hours the enemy opened fire upon the group from a nearby hill. The Americans began to return the enemy fire, whereupon a "GI" yelled from the enemy position to cease fire that they were GIs on the hill. The American group in the ditch ceased fire and started to get out of the ditch. The enemy then reopened fire upon the Americans. All but about 20 of the men in the ditch managed to withdraw to the position of safety. The enemy attacked the American position after the Americans had expended all of their ammunition and started beating the Americans on the heads and bodies with their rifles. The Americans emerged from the ditch and surrendered, clasping their hands over their heads and without weapons. They were marched up the side of the hill a short distance, lined up and shot by the enemy with rifles. Five of the EM known by the witnesses are now carried as "missing in action" in the personnel records of their unit. The area of the incident is yet to be explored.

Historical Report, Div. SJA cont'd

On 28 September a sworn statement was taken from an ex-Prisoner of War, a member of Co B, 23d Infantry Regiment. While he was a Prisoner of War in an enemy encampment and prior to his escape, he saw 3 American PW's hanged and 4 others burned alive. Investigation on this case, the "Hanging and Burning of Seven American Prisoners of War", is yet to be completed.

On 28 September the Assistant G-2 (Maj Wilkins), 2d Infantry Division, reported that elements of the 23d Infantry Regiment discovered approximately 200 dead bodies of Korean civilians in the vicinity of Chonju. They appeared to have been murdered by blows from blunt instruments, possibly picks and shovels. Colonel Ellis departed on 29 September to investigate this report and had not returned as of the terminal date of this report.

Captains Stenhouse and Rabbitt were relieved from their defense positions on 23 September and returned to their duties at Ivanhoe Rear.

Two Boards of Inquiry are being processed by the Section, one involving a Major and one a Captain. Major Ivory was detailed as member of one of the boards while Captain McGuigan was detailed as Defense Counsel and CWO Phillips as Recorder on both Boards.

The Court-Martial work-load remained relatively light during the month. The following cases were tried:

- 4 Special Courts-Martial
- 7 Summary Courts-Martial

There were no general Courts-Martial held during the month, nor were there any under investigation on the 30th of September.

HISTORICAL REPORT
Division Staff Judge Advocate
2d Infantry Division

FOR THE PERIOD 1 October -- 31 October 1950

The month of October might be called the month of moves for the JA Section, for it was, by far, the busiest moving month of the War for the Ivanhoe (Rear) CP. The first move began when the month was only four and one-half hours old; the destination -- Chinju, and therein lies a story worthy of note. Col Ellis and Major Ivory were not present at the time of the move, for the reason that they were in the forward area pursuing War Crimes Investigations. On 29 September 1950, Col Ellis had proceeded to Anui, Korea; thence to Chonju, Korea, on 30 September where he investigated atrocities committed against South Korean civilians. It was in the Chonju area at the approximate period 26 -- 27 September 1950, that the hastily departing North Korean Occupation officials committed the following atrocities:

- a. Twenty-five (25) unknown South Koreans were beaten to death in the courtyard of the Kun Master's House, Jong Dong Street, Chonju City.
- b. An estimated 100 South Korean policemen, government officials and political leaders were beaten to death and buried near the Chonju Crematory.
- c. An unknown number of South Korean land owners, policemen, government officials and political leaders had their hands tied behind their backs and were brutally beaten to death and buried in the near vicinity of Chonju Prison. The number of victims in this mass murder was estimated to be between six hundred (600) and two thousand (2000).
- d. Thirty (30) South Korean Government officials and Seminary students from Seoul, Korea, were murdered in the Rock Quarry near the Presbyterian Mission Hospital, Chonju City. The victims were placed in a hole dug at the

base of a rock cliff and the rock dynamited down upon them.

e. In Woo Tong Village near Chonju City, members of the Peoples Army (North Korean) beat to death eleven (11) South Koreans in the cemetery.

f. During the occupation of Chonju City, the Catholic Church and Compound was used by the North Koreans as organizational headquarters, this being the period of August and September 1950. The altar, images and statues of the Church were defaced, broken and destroyed, in most instances beyond repair.

On 3 October 1950, Col Ellis proceeded to Sochon, Korea, where he investigated the "Sochon Jail" case. On 27 September 1950, the jail at Sochon was burned by the North Korean Occupation Forces just prior to their withdrawal and some 280 landowners, South Korean Policemen and Government officials perished therein. Upon completing these investigations, Col Ellis returned to the Rear CP on 7 October.

Major Ivory was absent at the time of October's first move, having arrived in Chonju on 30 September. From Chonju he proceeded to Anui where he investigated the mass murder of approximately two hundred fifty (250) South Korean civilians by North Korean troops prior to their withdrawal from the advancing United Nations Forces. The results of this investigation were turned over to the S-2, 9th Infantry Regiment, 2d Infantry Division (Capt Jones) with the request that he continue the investigation with the cooperation of the local South Korean Police. Thence Major Ivory proceeded to Hiryang, Korea, where he procured lengthy written statements from a North Korean Major and Lieutenant who were alleged to have been participants in the Anui massacre. Major Ivory returned to the Rear CP on 6 October.

Captains McGuigan and Stenhouse were also absent from Hiryang at the time of the Chinju move. They had gone to Chinju, as members of the advance

party, on 29 September.

Thus the only Section members present for the move to Chinju were Capt Rabbitt, CWO Phillips and Sgt Tanner. After a 4:30 AM breakfast at Miryang on 1 October, the section entrained at 0700 hours. The train departed Miryang at 0900 hrs arriving at Masan at 1120 hours. (The original plan for the move estimated that the time of arrival at Chinju would be approximately 1300 hours, 1 October.) At Masan orders to detrain were received, with the assurance that the section would continue the trip to Chinju in "gondolas" (open box-cars) within a very few minutes. Emergency rations had not been provided. The few minutes grew into hours and hours into the rest of the day and night of 1 October. Section personnel, together with approximately 200 other Rear troops spent the night in boxcars, all of the following day (2 October) finally departing Masan at 2300 hours, 2 October. The stopover in Masan was of six hours duration amid heavy precipitation which began at 1900 hours, 2 October, and continued throughout the trip, which was finally completed at 1100 hours on 3 October.

The section remained in Chinju for only two days, departing therefrom at 1040 hours on 6 October destined for Chonju. The move was accomplished by truck convoy arriving at Chonju at 1935 hours, 6 October.

The stay at Chonju was also short lived, for on 15 October the CP was moved to Yong-dong-po, just south of Seoul City, and for the first time the Rear CP was joined with Ivanhoe Forward CP and, the Division being in EUSAK Reserve, assumed a garrison status. As of the last day of October the Rear CP is still situated at Yong-dong-po with 2d Divarty, Ivanhoe Forward having gone into the Pyongyang area on 28 October 1950.

On 8 October while still at Chonju, a Board of Inquiry was convened in the case of an officer of the 2d Engineer Combat Battalion. Major Ivory

served as a member of the Board; Capt McGuigan as Defense Counsel and CWO Phillips as Recorder. On this same date Capt Stenhouse went to the Impel area and represented an officer of the 38th Infantry Regiment at the formal pre-trial investigation (AW 46b).

Also on 8 October Sergeant Serge A. Belmont, AG (Enlisted Section), joined the Section as Clerk-Interpreter. Sgt Belmont speaks and translates some seven languages including Korean.

On 8 October, Capt Babbitt visited the Inspire Area and investigated the possible War Crime known as the "Uptegrath Case". Investigation revealed that on the night of 31 August-1 September 1950, members of the NK Army shot and killed three (3) unidentified, captured American Prisoners of War in the vicinity of Pugong-ni, Korea. One identified and 3 unidentified captured American soldiers were forced to carry heavy loads of ammunition for the enemy forces on 1 September 1950, during which time the North Korean soldiers killed at least three more wounded United States soldiers. Three unidentified prisoners, used as ammunition bearers, were later shot and severely wounded by the North Korean soldiers and abandoned to die on 1 September 1950.

Identified Victim: Harold L. Uptegrath, RA 18 343 400, Pfc Tokyo General Hospital

Possible victims, all of Company C, 23d Infantry Regiment, 2d Infantry Division, who were known to have been present at the outpost with Pfc Uptegrath. All presently carried as MIA:

Roess, Robert P.	Floras, Willie	Sanczyk, Stanley J.
Hollenbaugh, Roy W	Pumpas, Earl G.	Hart, Rex B.
Konze, Anthony	Farra, Jesus	Johnson, Ray
Meadows, Carl J.	Torres, Luis P.	

On 9 October 1950, Capt Babbitt departed Chonju at 0800 hours arrived at 1430. He established contact with police headquarters at 1530 and

preliminarily interviewed Kim Ul Sup and Ch Sund Do, two NK soldiers, accused of a War Crime. Then on 10 October 1950, he interviewed Kim Ul Sup and located a photographer who had the atrocity pictures, and interviewed and took the statement of Choi Bong Rim, a school teacher and survivor of the massacre. He also took short statement of the photographer. Through these men, Capt Babbitt finally established contact with Dr. Whang, a leading citizen whom the police didn't know. On 11 October 1950, Capt Babbitt viewed the scene of the alleged crime and took pictures thereof and obtained the statement of Wang Jun Man, son of Dr. Whang, and of Ch Sun Do. He departed Kongju at 1800 and arrived at Chonju at 2030 hours, 11 October 1950.

On 9 October 1950, Col Ellis flew to Taegu and discussed JA matters with the EMSAK Judge Advocate, Colonel Chester D. Silvers. He returned to the Rear CP at 1515 hours on the same date.

Also on 9 October, CWO Phillips visited the Regimental CP (Inspire) of the 23d Infantry and conferred with Colonel Edwin J. Messinger regarding arrangements for a Board of Inquiry requested by an Officer of 38th Infantry Regiment. Plans were laid to hold the Board hearing at Ivanhoe Forward CP at 0900 hours, 13 October 1950. This Board was completed on 14 October 1950, with Capt McGuigan as Defense Counsel and CWO Phillips, Recorder.

Lt Colonel M. W. Hawlehurst, JAGC, 038723, formerly I Corps Judge Advocate, joined the 2d Infantry Division at Suwon, on 12 October 1950, and assumed the duties as Division Staff Judge Advocate on 14 October upon the Section's arrival at the CP base at Yung-dung-po. Colonel Ellis departed for his new assignment as I Corps Judge Advocate on 15 October

1950:

On 19 October a party consisting of Capt Theodore Robbins, Investigating Officer, Capt McGuigan, Defense Counsel, Capt Labbitt, Trial Judge Advocate, Sgt Belmont, interpreter, the accused, Corporal Frank M. Sebastia, 2d Signal Company, 2d Infantry Division, and the driver, Cpl Meyers departed for Chonju for the purpose of investigating a charge of rape made by Kwagg Kugg Phaw, South Korean female. The group departed Ivanhoe rear at 0900 hours arriving at the Kum River ford at approximately 1540 hours where the truck ran off the ford and became inoperable. The group spent the night at the Kongju Police Station. On 20 October the three officers and Sgt Belmont "hitch hiked" back to Ivanhoe Rear, arriving at 2315. The accused and Cpl Meyers returned to Ivanhoe with the vehicle at 2130 hours 23 October with the mission not accomplished. An attempt is now being made to obtain depositions in the case, with the assistance of the 25th Infantry Division personnel.

On Saturday 21 October, Master Sergeant Roderic F. Rusch, the JA Section Chief Clerk, who was evacuated thru hospital channels to the 35th Station Hospital, Kyoto, Japan, on 20 August 1950, at the time of our landing at Pusan, Korea, was returned to the Division for full military duty and resumed his normal duties.

On 23 October, Lt Col King, Legal Officer with NEAG, and Lt Col Willis Potter, GPO, JA office visited the section in connection with Military Justice, foreign claims and civil affairs matters, insofar as they pertain to the Division Judge Advocate. Judge Advocate matters of general interest were also discussed.

Major Ivory, Capt Stanhouse and Sgt Belmont left the Section on 25 October for 10 days temporary duty with the Judge Advocate Section, I

SECRET

The Summary and Special Courts-Martial workload increased somewhat, for during the month 28 Summary and 7 Special records of trial were received in the Section.

The Division record of having no General Courts-Martial since 1 July 1950 remained intact, however as of 31 October, plans were being made to convene the initial General Court-Martial for the trial of an officer charged with violation of the 75th Article of War.

SECRET

Corps, to assist that Section in the investigation of War Crime atrocities.

SECRET

It was also on 25 October that Lt. Col. Levy, GHA JA Office, and Capt Petkoff, EMSAK Judge Advocate Section, visited the Section in connection with War Crimes Investigations and a cursory review of pending cases was made.

Capt Stanhouse was recommended for the Bronze Star on 23 October for meritorious achievement during the period 31 August-22 September 1950, while Assistant Commander and Commander of "Task Force Strom". Capt Babbitt was recommended for the Army Commendation Ribbon for his meritorious achievement as Executive Officer of the Same Task Force.

Capt Babbitt, CWO Phillips and Kim Ki Hyon, the Section Interpreter, departed on 27 October for the Inpire area to investigate a reported atrocity in the village of Miryik-tong, 30 miles north of Maeju. Investigation revealed that on or about 12 thru 14 October 1950, from 40 to 80 United Nations sympathizers (North Korean civilians) were murdered by the Communist Occupation officials while held in the cellar of the local "red" police station. The victims included men, women and children. Forty of the victims were buried in a common grave immediately to the rear of the communist police station.

The month of October saw legal assistance reach its peak since "Operation Korea" commenced. Approximately 20 individuals were advised concerning their problems, the majority of which had to do with domestic affairs.

Considerable attention was paid to the claims problems which will undoubtedly arise in the near future especially foreign claims (AR 25-90). Pertinent instructions to all Division units were drafted and submitted to the Division AG for publication.